

**USER MANUAL**

---

**AUTO KERATO-REFRACTOMETER  
KR-800PA**



# INTRODUCTION

Thank you for purchasing the Auto Kerato-Refractometer KR-800PA.

---

## **INTENDED USE / INDICATIONS FOR USE**

This instrument is used to measure the spherical refractive-power, cylindrical refractive power, the direction of cylindrical axis, the radius of curvature, to compute the corneal refractory power, corneal cylindrical power and the corneal cylindrical axis angle.

In the same way, the radius of curvature of the corneal surface of the human eye is measured, and the corneal refractive power distribution on the surface of the cornea is measured.

---

## **FEATURES**

**This instrument features the following:**

- The auto alignment function facilitates to get fine alignment and to start measurement automatically.
- Measure and analyze the shape of the cornea, and display the result as a color map.
- Simultaneous and coaxial measurement of mapping and REF/KRT shortens measurement time. It also realizes space saving.

---

## **PURPOSE OF THIS MANUAL**

This User Manual provides an overview of the basic operation, troubleshooting, checking, maintenance and cleaning of the TOPCON Auto Kerato-Refractometer KR-800PA.

To get the safety use of the instrument, read "DISPLAYS AND SYMBOLS FOR SAFE USE" and "GENERAL SAFETY INFORMATION".

Keep this Manual at hand for future reference.

---

<b>[CAUTION]</b> Federal law restricts this device to sale by or on the order of a physician.
---



Since this product partly uses a program derived from IPA Font, using the product is regarded as consent to the IPA Font License Agreement v1.0.  
For the IPA Font License Agreement v1.0, see page 88 or the following URL.  
[http://ipafont.ipa.go.jp/ipa\\_font\\_license\\_v1.html](http://ipafont.ipa.go.jp/ipa_font_license_v1.html)

- 
1. No part of this manual may be copied or reprinted, in whole or in part, without prior written permission.
  2. The contents of this manual are subject to change without prior notice and without legal obligation.
  3. The contents of this manual are correct to the best of our knowledge. Please inform us of any ambiguous or erroneous descriptions, missing information, etc.
  4. Original Instructions  
This manual was originally written in English.
-

# CONTENTS

INTRODUCTION .....	1
DISPLAYS AND SYMBOLS FOR SAFE USE .....	6
DISPLAY .....	6
SYMBOL .....	6
GENERAL SAFETY INFORMATION .....	7
HOW TO READ THIS MANUAL .....	8
GENERAL MAINTENANCE INFORMATION .....	8
USER MAINTENANCE .....	8
CLEANING OF MEASURING WINDOW .....	8
DISCLAIMERS .....	8
POSITIONS OF WARNING AND CAUTION INDICATIONS .....	9
<b>STANDARD ACCESSORIES</b> .....	10
<b>COMPONENTS</b> .....	
COMPONENT NAMES .....	11
COMPOSITION OF PARTS THAT COME IN CONTACT WITH THE PATIENT .....	11
OPERATION METHOD OF TOUCH PANEL .....	12
TOUCH PANEL COMPONENTS .....	12
FUNCTION BUTTON (WHEN THE MAPPING FUNCTION IS OFF) .....	13
FUNCTION BUTTON (WHEN THE MAPPING FUNCTION IS ON) .....	14
MONITOR SCREEN .....	15
MEASUREMENT SCREEN .....	15
SETTINGS SCREEN .....	15
CORNEA DIAMETER MEASUREMENT SCREEN .....	15
MAPPING SCREEN .....	16
PRINTER OUTPUT .....	18
PRINTOUT FORMAT SETTING .....	21
<b>PREPARATIONS</b> .....	
INSTALLATION .....	22
CONNECTING POWER CABLE .....	22
CONNECTING EXTERNAL I/O TERMINALS .....	23
DATA OUTPUT .....	23
DATA INPUT .....	23
PRINTER PAPER SETTING .....	24
REGION SELECTION OF THE INITIAL STARTUP .....	25
RESETTING THE REGION TO BE USED .....	26
RECOVERY FROM POWER SAVE STATUS .....	27
<b>BASIC OPERATIONS</b> .....	
PREPARATION BEFORE MEASUREMENT .....	28
TURNING ON THE INSTRUMENT .....	28
SELECTING THE MEASUREMENT MODE .....	28
PATIENT POSITIONING .....	29
MEASUREMENT IN SEMI-AUTO MODE .....	31
SETTING THE SEMI-AUTO MODE .....	31
ALIGNMENT AND MEASUREMENT .....	32
DISPLAYING MEASUREMENT VALUES .....	36
MEASUREMENT IN AUTO SHOOT MODE .....	36
SETTING THE AUTO SHOOT MODE .....	36
ALIGNMENT AND MEASUREMENT .....	37
DISPLAYING MEASUREMENT VALUES .....	39
MEASUREMENT IN MANUAL MODE .....	40
SETTING THE MANUAL MODE .....	40



ALIGNMENT AND MEASUREMENT .....	40
DISPLAYING MEASUREMENT VALUES .....	41
MEASUREMENT IN PERIPHERAL MEASUREMENT MODE .....	42
PREPARATION FOR THE PERIPHERAL MEASUREMENT .....	42
MAPPING MEASUREMENT .....	44
PREPARATION FOR THE MAPPING MEASUREMENT .....	44
PRINT-OUT OF MEASUREMENT VALUES .....	46
MEASUREMENT IMAGE OBSERVATION .....	47
MEASUREMENT IMAGE OBSERVATION .....	47
DISPLAYING ALL MEASUREMENT DATA .....	48
CLEARING MEASUREMENT VALUES .....	50
OPERATION OF AFTER USE .....	50
<b>OPTIONAL OPERATIONS</b>	
DISPLAYING THE PATIENT ID (PATIENT No.) OR OPERATOR ID .....	51
MEASUREMENT OF CORNEA DIAMETER .....	51
MEASUREMENT ON THE ACTUAL IMAGE .....	51
MEASUREMENT ON THE STILL IMAGE .....	53
MEASUREMENT OF HARD CONTACT LENS .....	54
OUTPUT USING RS-232C .....	55
INPUT USING USB .....	55
OUTPUT USING LAN .....	55
<b>SETTING FUNCTIONS ON SETUP SCREEN</b>	
OPERATING THE SETUP SCREEN .....	56
PREPARATIONS FOR SETTING .....	56
OUTLINE OF SETUP SCREEN OPERATIONS .....	57
RETURNING TO THE MEASUREMENT SCREEN .....	59
LIST OF SETUP ITEMS .....	60
INITIAL (INITIAL SETTING) .....	60
SETTING OF INTERNAL PRINTER (PRINT) .....	63
DATA COMMUNICATION (COMM) .....	65
LAN CONNECTION (LAN) .....	66
OPERATOR ID .....	66
SPECIAL .....	66
<b>MAINTENANCE</b>	
DAILY CHECKUPS .....	67
USER MAINTENANCE ITEM .....	67
MANUFACTURER MAINTENANCE ITEMS .....	67
MAINTENANCE AFTER USE .....	67
CHECKING THE MEASURING ACCURACY .....	68
BRIGHTNESS ADJUSTMENT OF TOUCH PANEL .....	68
HOW TO CLEAN THIS INSTRUMENT .....	69
CLEANING THE FOREHEAD REST AND CHIN REST .....	69
CLEANING THE PLACIDO RING AND THE COVER .....	69
CLEANING THE TOUCH PANEL .....	69
CLEANING THE MEASURING WINDOW .....	69
REPLACING AND ORDERING CONSUMABLE ITEMS .....	70
ORDERING CONSUMABLE ITEMS .....	70
SUPPLYING THE CHINREST TISSUE .....	70
<b>TROUBLESHOOTING</b>	
TROUBLE-SHOOTING OPERATIONS .....	71
MESSAGE LIST .....	71
TROUBLE-SHOOTING OPERATIONS .....	74
PRINTER PAPER JAM .....	75

<b>SPECIFICATIONS AND PERFORMANCE</b>	
SPECIFICATIONS AND PERFORMANCE .....	76
<b>GENERAL INFORMATION ON USAGE AND MAINTENANCE</b>	
INTENDED PATIENT POPULATION .....	77
INTENDED USER PROFILE .....	77
ENVIRONMENTAL CONDITIONS OF USE .....	77
STORAGE, USAGE PERIOD .....	77
ENVIRONMENTAL CONDITIONS FOR PACKAGING IN STORAGE .....	77
ENVIRONMENTAL CONDITIONS FOR PACKAGING IN TRANSPORTATION.....	78
ELECTRIC RATING.....	78
SAFETY DESIGNATIONS PER IEC 60601-1 STANDARD .....	78
DIMENSIONS AND WEIGHT .....	78
OPERATION PRINCIPLE .....	79
DISPOSAL .....	79
ELECTROMAGNETIC COMPATIBILITY.....	80
REQUIREMENTS FOR THE EXTERNAL DEVICE .....	83
PATIENT'S ENVIRONMENT .....	84
SAFETY OF LED PRODUCT .....	85
<b>REFERENCE</b>	
OPTIONAL ACCESSORIES.....	87
SHAPE OF PLUG .....	87
<b>IPA FONT LICENSE AGREEMENT v1.0</b> .....	88











# DISPLAYS AND SYMBOLS FOR SAFE USE

In order to encourage the safe use of the instrument and to avoid danger to the operator and others as well as damage to properties, warnings are described in the User Manual and marked on the instrument body. We suggest you thoroughly understand the meaning of the following displays/icons and Safety Cautions, as well as read the Manual, and strictly observe the instructions.

## DISPLAY

DISPLAY	MEANING
 <b>WARNING</b>	A WARNING is provided to alert the user to potential serious outcomes (death, injury, or serious adverse events) to the patient or the user.
 <b>CAUTION</b>	A CAUTION is provided to alert the user to use special care necessary for the safe and effective use of the device. They may include actions to be taken to avoid effects on patients or users that may not be potentially life threatening or result in serious injury, but about which the user should be aware. Cautions are also provided to alert the user to adverse effects on this device of use or misuse and the care necessary to avoid such effects.
 <b>NOTE</b>	A NOTE is provided when additional general information is applicable.

## SYMBOL

Symbol	IEC/ISO Publication	Description	Description (French)
	IEC 60417-5032	Alternating Current	Courant alternatif
	IEC 60417-5008	Off (power: disconnection from the main power supply)	Éteint (courant: coupure avec le secteur)
	IEC 60417-5007	On (power: connection to the main power supply)	Allumé (courant: raccordement sur le secteur)
	IEC 60878-02-02	Type B applied part	Partie appliquée du Type B
	ISO 7010-W001	General warning sign	Symbole d'avertissement général
	ISO 7010-M002	Refer to instruction manual/ booklet	Voir le manuel/la brochure
	ISO 7000-2497	Date of manufacture	Date de fabrication
	ISO 7000-2498	Serial number	Numéro de série
	ISO 7000-3082	Manufacturer	Fabricant
	ISO 15223-1	Authorised Representative in the European Community	Représentant autorisé pour l'Union européenne



# GENERAL SAFETY INFORMATION

## **WARNING**

### **Ensuring the Safety of Patients and Operators**

When operating the instrument, do not touch the patient's eye or nose.

Handling the cord on this product or cords associated with accessories sold with this product, will expose you to lead, a chemical known to the State of California to cause birth defects or other reproductive harm. Wash hands after handling.

### **Preventing Electric Shocks and Fires**

To avoid fire and electric shock, install the instrument in a dry place free of water and other liquids.

To avoid fire and electric shock, do not put cups or other containers with liquids near the instrument.

To avoid electric shocks, do not insert metal objects into the instrument body through the vent holes or gaps.

To avoid fire in the event of an instrument malfunction, immediately turn OFF the power switch "O" and disconnect the power plug from the outlet if you see smoke coming from the instrument, etc. Don't install the instrument where it is difficult to disconnect the power plug from the outlet. Ask your dealer for service.

## **CAUTION**

### **Important caution**

The following patients need extra attention.

- Patients with infectious disease such as Keratoconjunctivitis Epidemica

### **Ensuring the Safety of Patients and Operators**

To avoid injury when operating the instrument, do not touch the main body to the patient's eye or nose.

To avoid injury when operating the up/down button for chinrest, be careful not to catch the patient's fingers.

To avoid injury when operating the measuring head up or down, be careful not to catch the patient's/operator's fingers.

### **Preventing Electric Shocks**

To avoid injury by electric shock, do not open the cover. For repair, call your service engineer.

### **Electromagnetic Compatibility (EMC)**

This instrument has been tested (with 100/120/230V) and found to comply with IEC60601-1-2:Ed.3.0:2007. This instrument radiates radio frequency energy within standard and may affect other devices in the vicinity. If you have discovered that turning on/off the instrument affects other devices, we recommend you change its position, keep a proper distance from other devices, or plug it into a different outlet. Please consult your authorized dealer if you have any additional questions.

# HOW TO READ THIS MANUAL

Read the instructions on pages 1 to 9 before using the machine.

Regarding connection to various devices, see "CONNECTING EXTERNAL I/O TERMINALS" on page 23.

If you would like an overview of the system, begin by reading "BASIC OPERATIONS" (page 28).

For setting various functions, see "SETTING FUNCTIONS ON SETUP SCREEN" on page 56.

## GENERAL MAINTENANCE INFORMATION

### USER MAINTENANCE

To maintain the safety and performance of the equipment, never attempt to repair or perform maintenance. These tasks should be performed by an authorized service representative.

Maintenance tasks that can be performed by the user are as follows; for details, follow the manual's instructions.

### **CLEANING OF MEASURING WINDOW**

For details, See "CLEANING THE MEASURING WINDOW" on page 69.

## DISCLAIMERS

- TOPCON is not responsible for damage due to fire, earthquakes, actions or inactions of third persons or other accidents, or damage due to negligence and misuse by the user and any use under unusual conditions.
- TOPCON is not responsible for damage derived from inability to properly use this equipment, such as loss of business profits and suspension of business.
- TOPCON is not responsible for damage caused by operations other than those described in this User Manual.
- The device does not provide a diagnosis of any condition or lack thereof or any recommendations for appropriate treatment. The relevant healthcare provider is fully responsible for all diagnosis and treatment decisions and recommendations.

# POSITIONS OF WARNING AND CAUTION INDICATIONS

To secure safety, this equipment provides warnings.



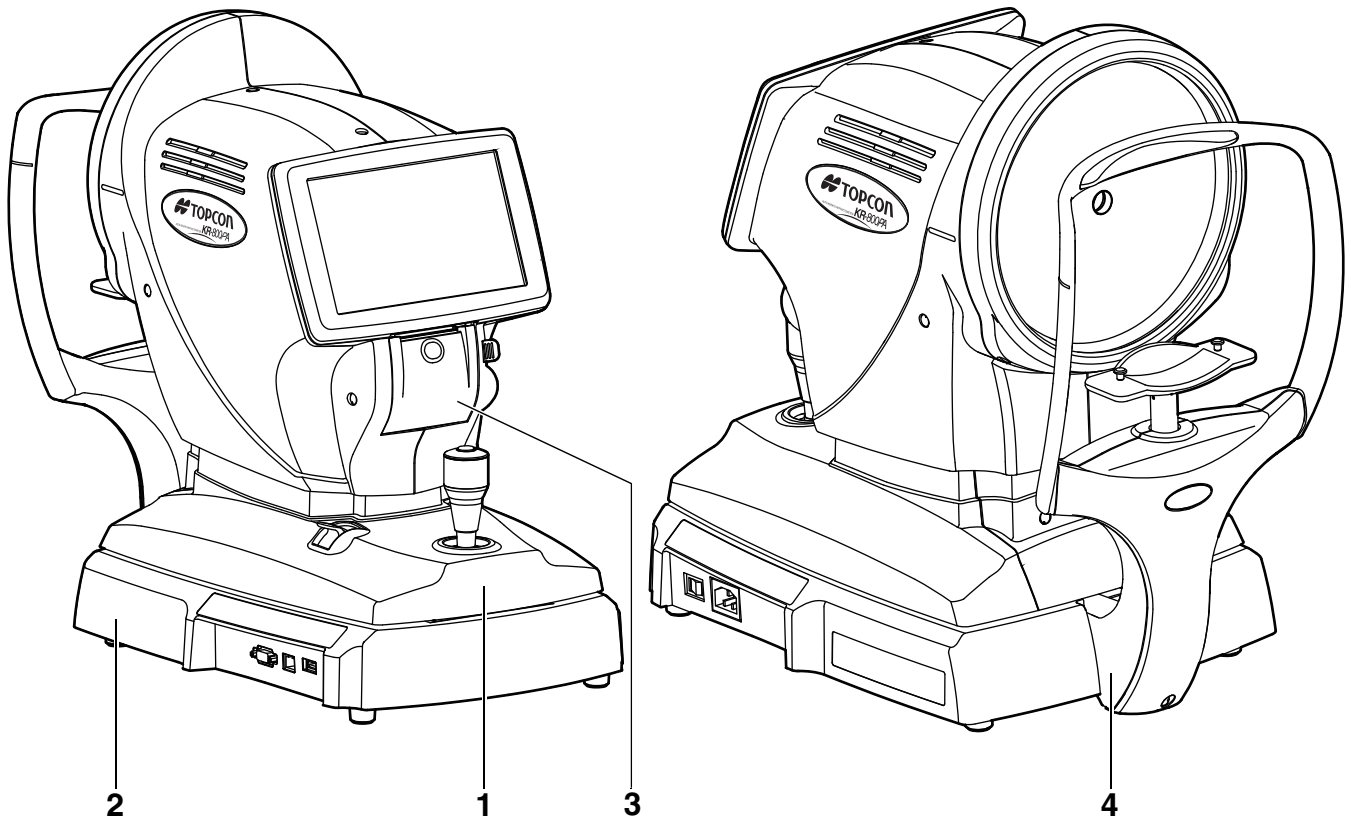



Correctly use the equipment following these warning instructions. If any of the following marking labels are missing, please contact your dealer or TOPCON at the address stated on the back cover.

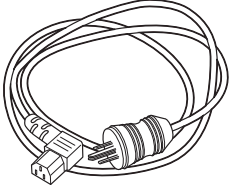
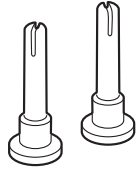
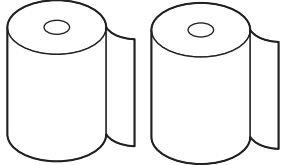

No.	Label	Meaning	Signification
1		<b>WARNING</b> Be careful not to hit the patient's eyes or nose with the instrument during operation.	<b>MISE EN GARDE</b> Prendre garde de ne pas frapper les yeux ou le nez du patient avec l'instrument pendant l'opération.
2		<b>CAUTION</b> To avoid injury caused by electric shock, do not open the cover. Ask your dealer for service.	<b>PRÉCAUTION</b> Ne pas ouvrir le couvercle pour éviter les blessures causées par un choc électrique. Demander au revendeur d'effectuer le service.
3		<b>CAUTION</b> Pay much attention not to touch the internal printer's body when the cover is open. If touched, it may result in trouble due to electrostatic discharge.	<b>PRÉCAUTION</b> Faites très attention à ne pas toucher le corps interne de l'imprimante lorsque le couvercle est ouvert. En cas de contact, des problèmes peuvent survenir en raison de la décharge électrostatique.
4		Degree of protection against electric shock: TYPE B APPLIED PART	Degré de protection contre les chocs électriques: TYPE B PARTIE D'APPLICATION

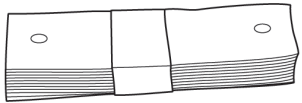
# STANDARD ACCESSORIES

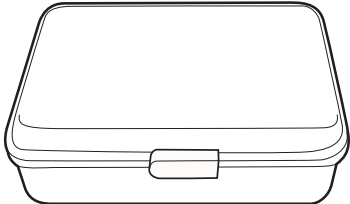
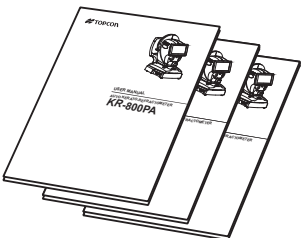
The following are standard accessories. Make sure that all these items are included (quantity).

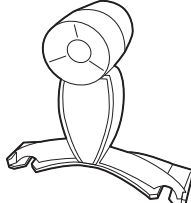
<p>Power cable (1)*<sup>1</sup></p> 	<p>Chinrest tissue pin (2)</p> 
<p>Printer paper (2)</p> 	<p>Monitor cleaner (1)</p> 
<p>Chinrest tissue (1)</p> 	<p>Dust cover (1)</p> 
<p>Accessory case (1)</p> 	<p>User manual, Instruction manual*<sup>2</sup>, Unpacking and Assembling (1 each)</p> 
<p>Measuring window cap (1)</p> 	<p>Model eye (1)</p> 

\*1 More than one power cable can be included on certain occasions.

\*2 Depending on the destination, this is not attached.

# COMPONENTS

## COMPONENT NAMES

### Main unit

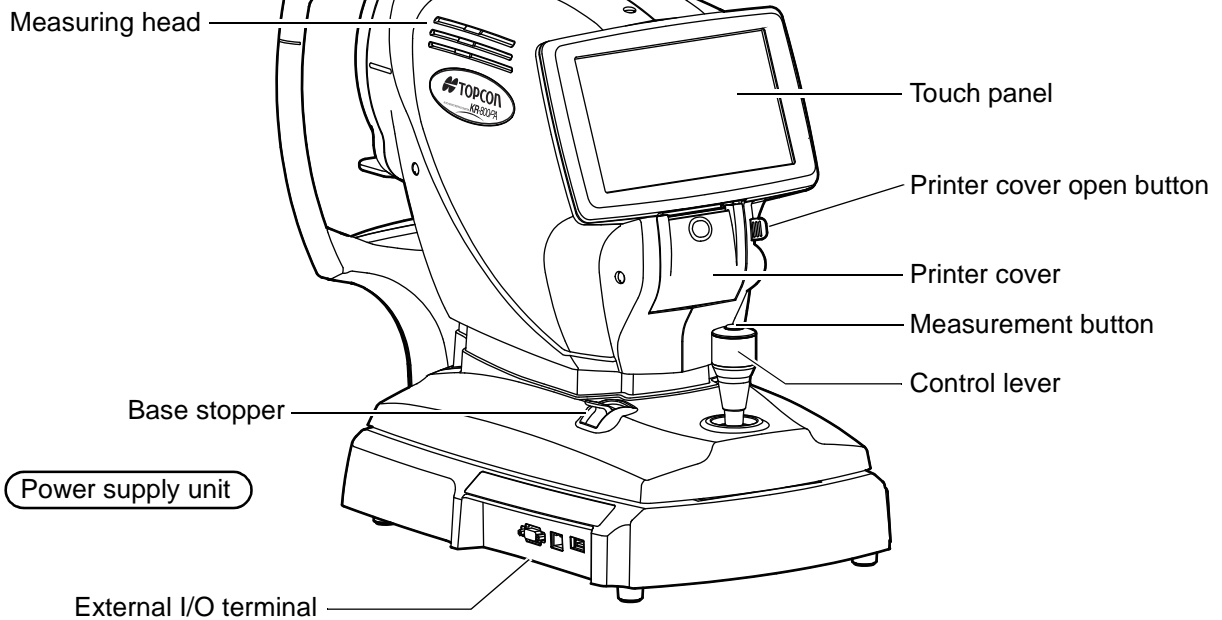

### Power supply unit

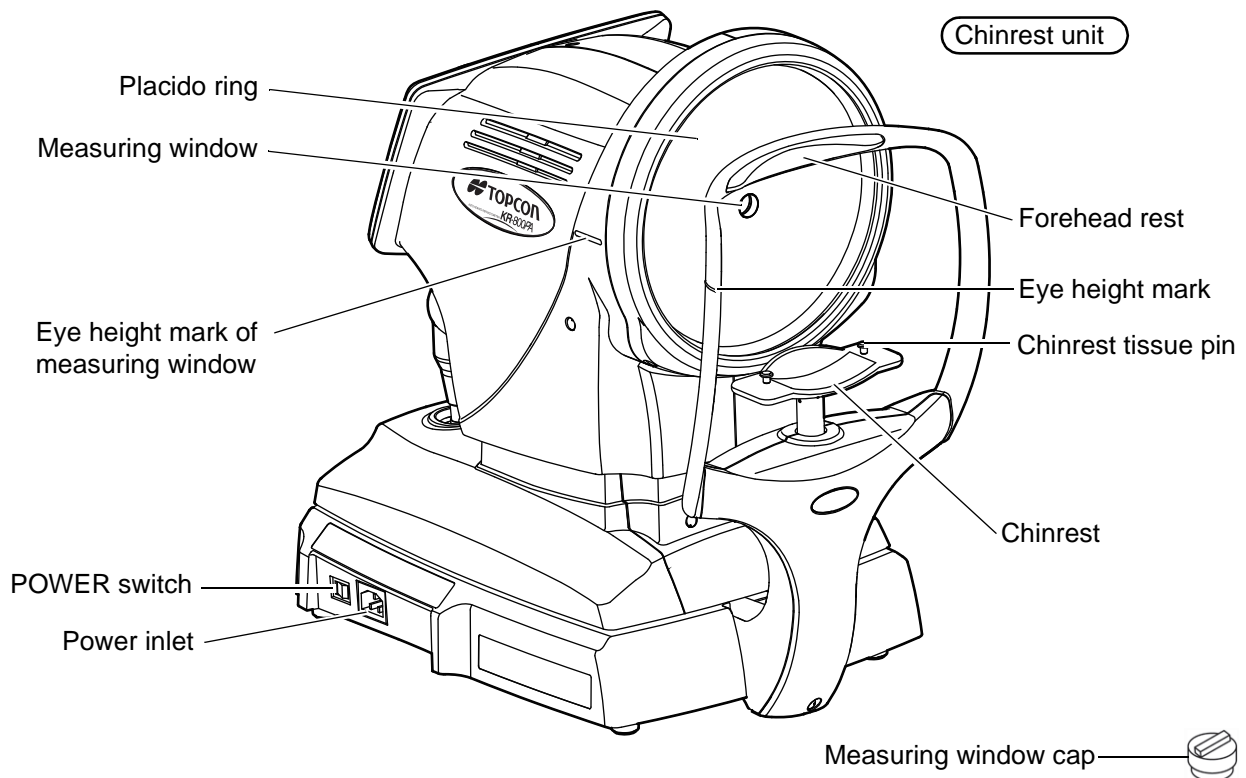

## COMPOSITION OF PARTS THAT COME IN CONTACT WITH THE PATIENT

- Forehead rest : Silicone rubber
- Chinrest : Acrylonitrile butadiene styrene resin

# OPERATION METHOD OF TOUCH PANEL

 <b>NOTE</b>	<p>Do not press the touch panel with a strong force enough to move the measuring head. This instrument may contact the patient and get injured.</p>
---	---

 <b>NOTE</b>	<ul style="list-style-type: none"> <li>• The touch panel is a touch panel. Do not use any sharp tools; e.g. ball point pen.</li> <li>• Do not touch two points on a touch panel simultaneously.</li> <li>• If machine is moved by tapping the touch panel during measurement, it might cause an incorrect measurement.</li> </ul>
---	---

Tap → Touch the touch panel softly with a finger.











## TOUCH PANEL COMPONENTS

The touch panel is designed for performing various operations and settings by touching on the screen. It displays images and shows information, including set conditions and measurement results.







 ID button .....Input the patient ID (up to 13 characters) and operator ID (up to 13 characters). However, if no patient ID is input, the patient No. is allocated automatically.

 Measurement mode button .....Selects a measurement mode from REF, KRT and R/K.

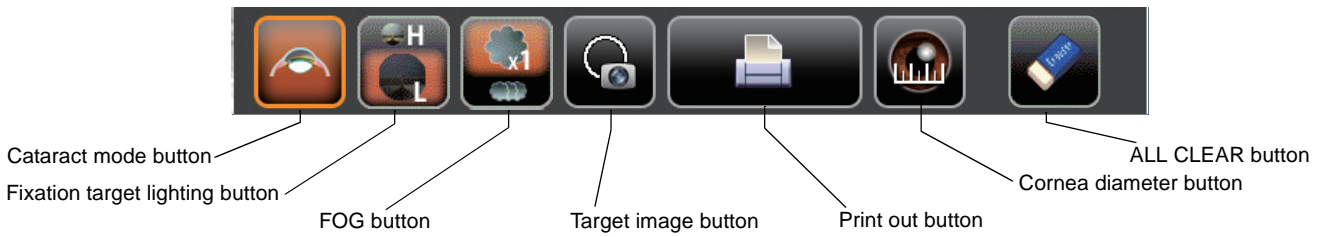
-  Center/Peripheral button .....During KRT measurement, select "C" to measure only the center, or "P" to perform peripheral KRT measurement.
-  R display/L display .....Shows the measured eye is R (Right eye) or L (Left eye). The measured eye is framed in orange.
-  Reset button.....Returns the measurement head (the side and the depth direction) to an initial position.
-  Alignment mode button .....Switches alignment (measurement position adjustment) mode.  
 "A" Semi-auto mode: If approaching the automatic measuring range, fine alignment and measurement are performed automatically.  
 "AS" Auto shoot mode: If reaching the measurable range by aligning manually, the measurement starts automatically.  
 "M" Manual mode: All processes are performed manually from alignment to measurement.
-  Settings button .....Displays the Settings screen.
-  Up/down button for chinrest.....Moves the chinrest up/down.
-  R/K  $\Leftrightarrow$  Mapping change button .....Switches the ON  and OFF  of the mapping function.

**FUNCTION BUTTON (WHEN THE MAPPING FUNCTION IS OFF)**



-  Cataract mode button.....If normal measurement is not performed due to a cataract, tapping this button to be the cataract mode may improve measurements. In the cataract mode, "CAT" is displayed on the touch panel and the button is framed in orange.
-  Fixation target lighting button .....Brightness of the fixation target can be changed.
-  FOG button.....Changes setting temporarily to perform fogging only in the first measurement or each time in the continuous measurement.
-  Target image button .....The captured measurement target can be observed on the touch panel.



Print out button .....Prints measurement results. Tap the button when no measurement data is present to feed the paper.  
By setting the printer mode to Graphic Printer on the Settings screen, figures showing refractive conditions can be printed.

In this case, the printer button changes to  .



Cornea diameter button.....Changes to cornea diameter measurement mode.



ALL CLEAR button .....Clears all measurement data.

### FUNCTION BUTTON (WHEN THE MAPPING FUNCTION IS ON)



Measuring ring lighting button

Mapping screen button

Mapping print out button



Measuring ring lighting button .....Brightness of the Placido ring can be changed on measuring.  
You can select 3 stages of H (high) / M (medium) / L (low).



Mapping screen button.....Moves to the screen for mapping result display.



Mapping print out button.....Prints mapping results. Tap the button when no measurement data is present to feed the paper.  
By setting the printer mode to Graphic Printer on the Settings screen, figures showing refractive conditions can be printed.

In this case, the printer button changes to  .



# MONITOR SCREEN

## MEASUREMENT SCREEN

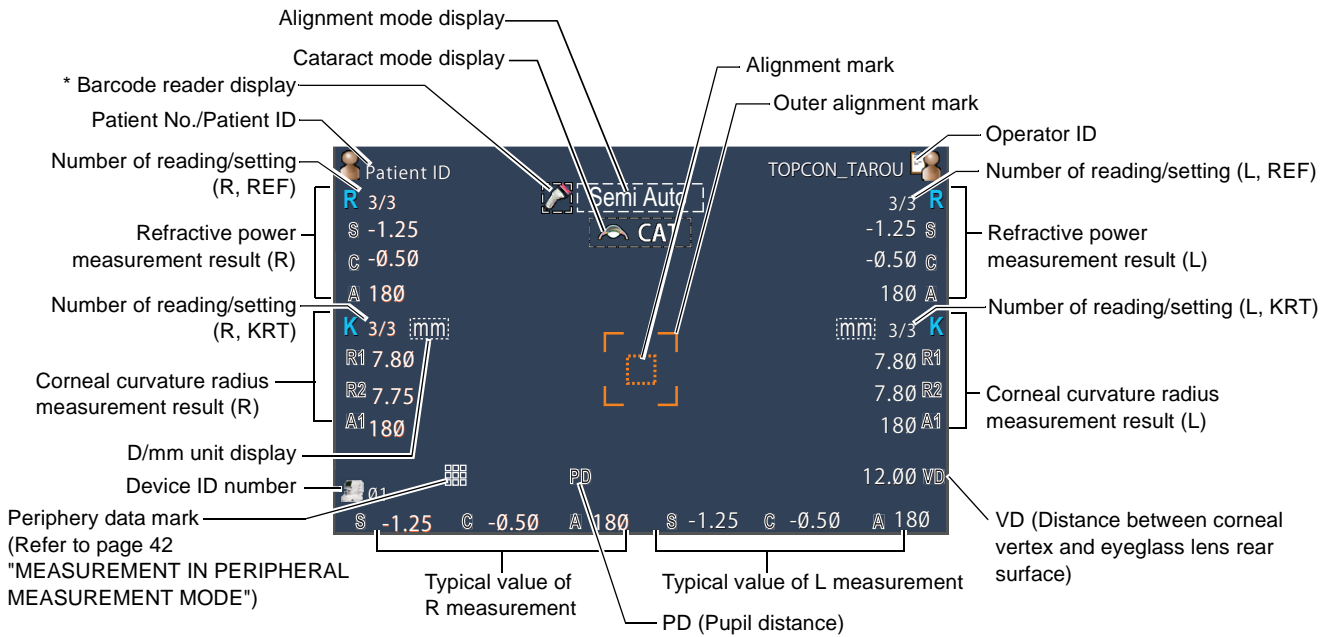

\* Displayed when the barcode reader is connected.

: Barcode reader is in readable.

: Barcode reader is inhibited to read. (During measurement, printing, data output)

## SETTINGS SCREEN

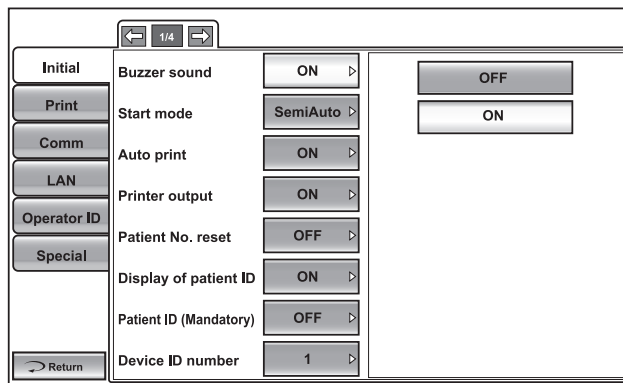

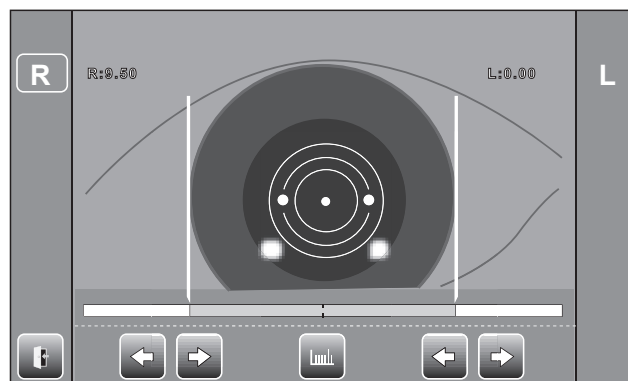

## CORNEA DIAMETER MEASUREMENT SCREEN

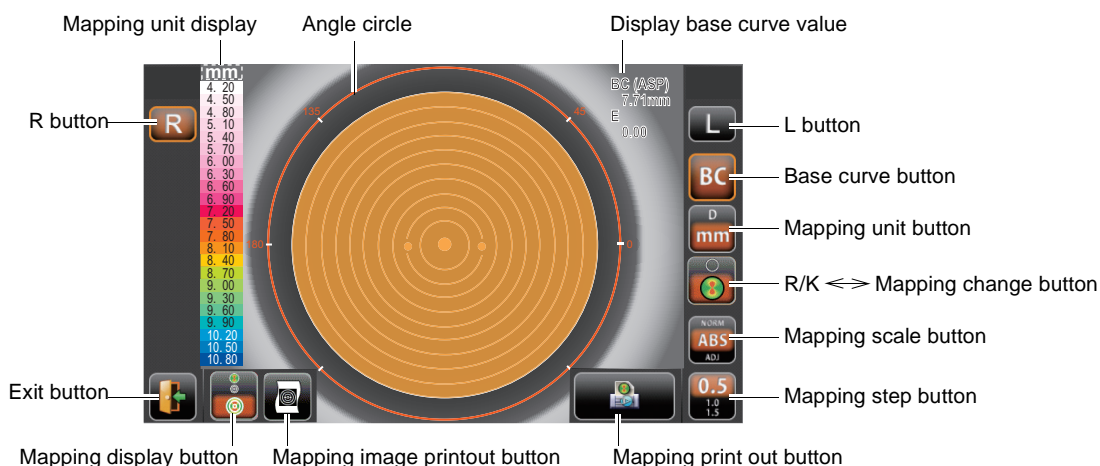

## MAPPING SCREEN



  R button/L button.....Switches mapping screen for right eye or left eye. The selected button L or R is framed in orange.

 Exit button.....Exits mapping screen and return to the measurement screen.

 Mapping display button.....Switches mapping display mode.

- Mapping: An opaque map is displayed overlaying on the anterior display.
- Anterior: Only the anterior image is displayed.
- Overlay:



 Mapping print out button.....Prints out mapping image and measurement results.

 Mapping image printout button.....Print out only the mapping image.

 BC display button .....Display base curve value.

To display the base curve value, you can select RGP or ASP according to the "Initial" "BC display type" settings on the settings screen.

 Mapping unit button.....Switches the display unit to Diopter or mm.

 R/K <=> Mapping change button .....In the data output, select whether to include mapping 

or not include .

 Mapping scale button .....Selects the mapping scale.

- NORM: Relative value scale  
The center of the scale is automatically determined based on the measurement result, and it is output in accordance with the mapping step.
- ABS: Absolute value scale  
The scale display range is fixed at 34.5D to 67.5D, and it is output with the fixed 1.5D of the mapping display step.
- ADJ: Adjustable relative value scale  
It is a relative value scale which can change the center value of the color code and the display step.



Mapping step button.....The mapping step can be selected from 0.5 D (0.1 mm), 1.0 D (0.2 mm) 1.5 D (0.3 mm).

# PRINTER OUTPUT

KRT typical value style and KRT print data are HV

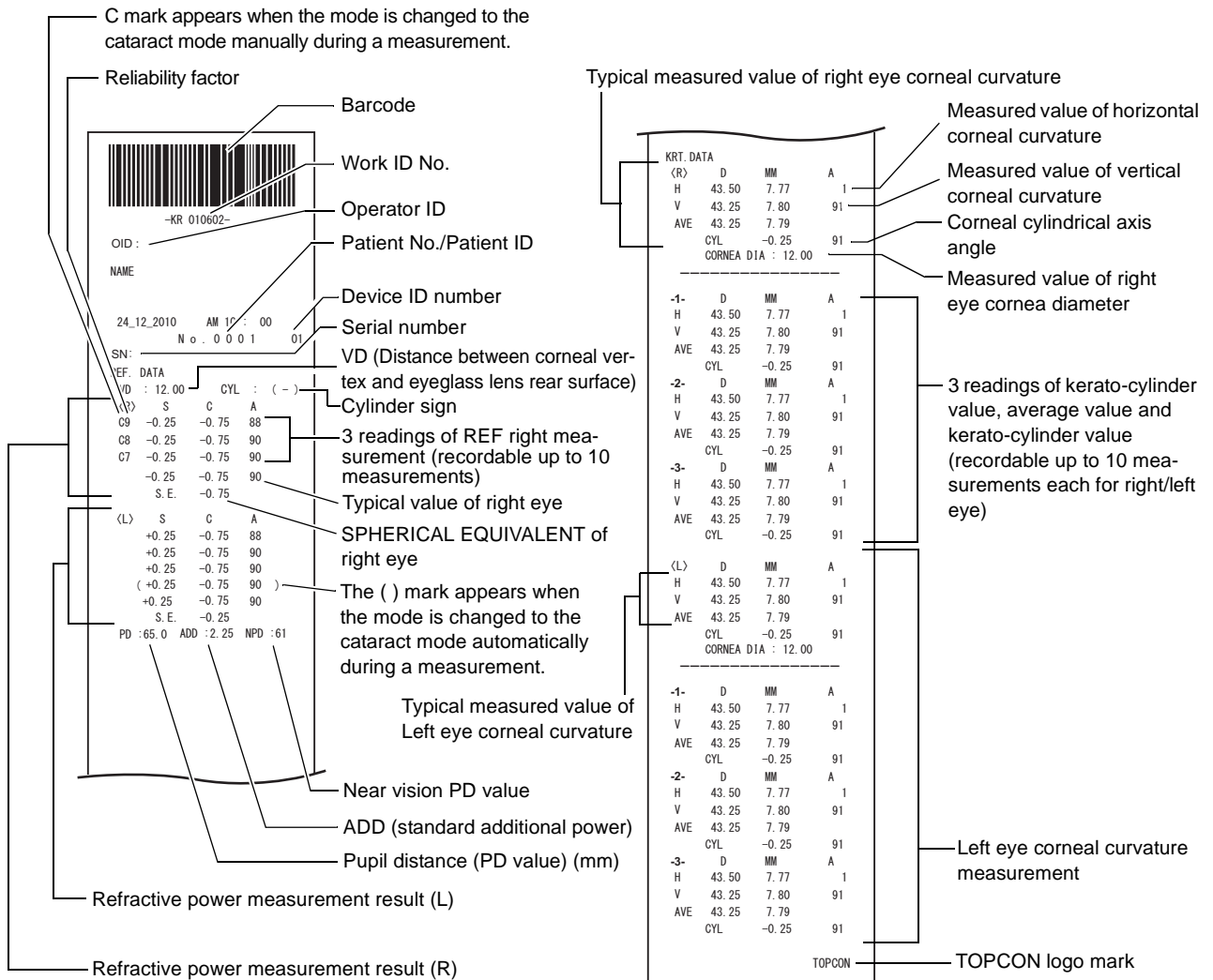

## NOTE

- The reliability factor is defined with integers 1 to 9 in increasing order of reliability. Additionally, if the reliability is high enough, the reliability factor is not shown on the printout.
- The Near PD value is calculated based on the ADD.
- C mark appears when the Cataract button is selected by manual operation. Adding the C mark occurs only for REF measurement values.
- ( ) mark appears when it is changed to the cataract mode automatically so that normal measurement is not performed due to a cataract and the like. Adding the ( ) mark occurs only for REF measurement values.

KRT typical value style and KRT print data are R1R2

Barcode

Work ID No. -KR 010602-

Operator ID

Patient No./Patient ID

Device ID number

Serial number

VD (Distance between corneal vertex and eyeglass lens rear surface)

Cylinder sign

3 readings of REF right measurement (recordable up to 10 measurements)

Typical value of right eye

Spherical equivalent of right eye

The ( ) mark appears when the mode is changed to the cataract mode automatically during a measurement.

Near vision PD value

ADD (ordinary additional power)

Pupil distance (PD value) (mm)

Measured value of flat meridian corneal curvature

Measured value of steep meridian corneal curvature

D: Average value of corneal refractive power  
MM: Average value of cornea curvature radius

Corneal cylindrical axial angle

Measured value of right eye cornea diameter (mm)

MM1: Corneal refractive power at flat meridian  
MM2: Corneal refractive power at steep meridian  
A1: Angle of flat meridian

\*-mark appears when reliability of the measurement is too low.

Reliability factor

C mark appears when the mode is changed to the cataract mode manually during a measurement.

Result of refractory power measurement (Right eye)

Result of refractory power measurement (Left eye)

KRT data (Right eye)

KRT data (Left eye)

TOPCON

NOTE

- The reliability factor is defined with integers 1 to 9 in increasing order of reliability. Additionally, if the reliability is high enough, the reliability factor is not shown on the printout.
- The Near PD value is calculated based on the ADD.
- C mark appears when the Cataract button is selected by manual operation. Adding the C mark occurs only for REF measurement values.
- ( ) mark appears when it is changed to the cataract mode automatically so that normal measurement is not performed due to a cataract and the like. Adding the ( ) mark occurs only for REF measurement values.
- \*-mark appears when reliability of the measurement is too low. Adding the \*-mark occurs only for KRT measurement values.

# Peripheral measurement mode and mapping data print

## Peripheral 5-point output mode

```

NAME
2017_09_29 AM 11:00
NO. 0001
SN:
REF.DATA
VD: 12.00 CYL: (-)
<R> S C A
-6.00
-6.00
-6.00
-6.00
S. E. -6.00
KRT.DATA
<R> D MM A
R1 42.25 7.99 175
R2 44.25 7.63 85
AVE 43.25 7.81
CYL: -2.00 175
MM1 MM2 A1
1 8.00 7.63 178
AVE 43.25 7.82
CYL: -2.00 176
2 7.99 7.63 175
AVE 43.25 7.81
CYL: -2.00 175
3 7.98 7.62 175
AVE 43.25 7.80
CYL: -2.00 175
MM ECC
PR1 ( 85 ) 8.02 0.74
( 265 ) 7.97 0.69
PR2 ( 175 ) 7.61 0.00
( 355 ) 7.64 0.00
BC (RGP / OZ:7.8) : 7.70mm

```

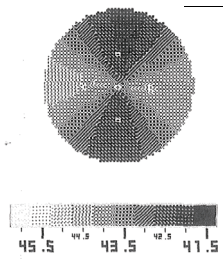

```

REF.DATA
<L> S C A
-6.00
-6.00
-6.00
-6.00
S. E. -6.00
KRT.DATA
<R> D MM A
R1 43.25 7.82 180
R2 43.75 7.69 90
AVE 43.50 7.76
CYL: -0.50 180
MM1 MM2 A1
1 7.72 7.71 180
AVE 43.75 7.72
CYL: -0.00 180
2 7.72 7.71 180
AVE 43.25 7.81
CYL: -0.00 172
3 8.01 7.65 172
AVE 43.25 7.83
CYL: -1.75 172
MM ECC
PR1 ( 148 ) 7.81 0.42
( 328 ) 7.81 0.41
PR2 ( 58 ) 7.69 0.00
( 238 ) 7.68 0.00
BC (RGP / OZ:7.8) : 7.70mm

```

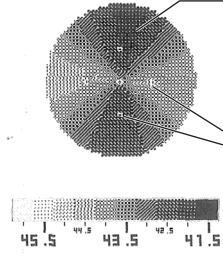

PD: 68.5

TOPCON

Radius of curvature around  $\phi 6.6$  mm and value E (along strong/weak principal meridians)

Recommended value BC of contact lens.

This is added when printing with the mapping print button.

Placido ring center

$\phi 3$  mm diameter mark

## Peripheral 9-point output mode

```

NAME
2017_09_29 AM 11:00
NO. 0001
SN:
REF.DATA
VD: 12.00 CYL: (-)
<R> S C A
-6.00
-6.00
-6.00
-6.00
S. E. -6.00
<L> S C A
-6.00
-6.00
-6.00
-6.00
S. E. -6.00
PD: 43.0
KRT.DATA
<R> D MM A
R1 43.75 7.72 180
R2 43.75 7.71 90
AVE 43.75 7.72
CYL: 0.00
MM1 MM2 A1
1 7.72 7.70 180
AVE 43.50 7.79
CYL: 0.00 180
2 7.71 7.70 180
AVE 43.75 7.71
CYL: 0.00 180
3 7.72 7.72 180
AVE 43.75 7.72
CYL: 0.00 180

```

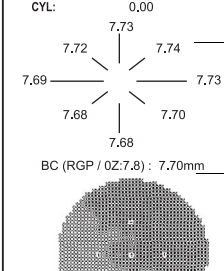

```

BC (RGP / OZ:7.8) : 7.70mm

```

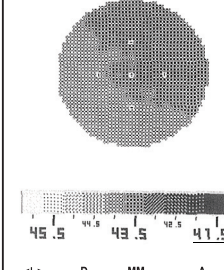

```

<L> D MM A
R1 43.75 7.71 180
R2 43.75 7.71 90
AVE 43.75 7.71
CYL: 0.00
MM1 MM2 A1
1 7.71 7.70 180
AVE 43.75 7.71
CYL: 0.00 180
2 7.71 7.71 180
AVE 43.75 7.71
CYL: 0.00 180
3 7.72 7.71 180
AVE 43.75 7.72
CYL: 0.00 180

```

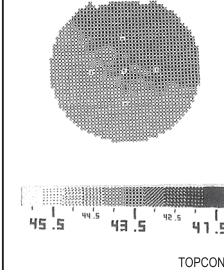

PD: 68.5

TOPCON

Radius of curvature around  $\phi 6.6$  mm

The distribution of corneal radius of curvature is shown in terms of concentration.

## PRINTOUT FORMAT SETTING

Printout format can be changed by pushing "Print" in the Settings screen. For Print settings, see "SETTING FUNCTIONS ON SETUP SCREEN" on page 56.

### PRESET

All: Initial setting (all measurement values are printed.)

Ave: Only average values are printed.

Classic: Equivalent with RM/KR-8900 Classic 2

	ITEM	INITIAL	PRESET		
			All	Ave	Classic* <sup>1</sup>
Common	Barcode	OFF	OFF	OFF	OFF
	Operator ID	OFF	OFF	OFF	OFF
	Name	ON	ON	ON	ON
	Date	ON	ON	ON	ON
	Date style	DMY*	DMY*	DMY*	DMY*
	Patient No./Patient ID	ON	ON	ON	ON
	Device ID number	OFF	OFF	OFF	OFF
	Serial number	ON	ON	ON	ON
	Include error data	OFF	OFF	OFF	OFF
	TOPCON logo	ON	ON	ON	ON
	Message print	OFF	OFF	OFF	OFF
	Input message	NULL	NULL	NULL	NULL
	Graphic print	Normal Printer	Normal Printer	Normal Printer	Normal Printer
	Line space	0	0	0	0
Auto Cut	ON	ON	ON	ON	
REF/KRT* <sup>1</sup>	Print Layout	DATA	DATA	DATA	DATA
	VD	ON	ON	ON	ON
	Cylinder sign	ON	ON	ON	ON
	Print form of REF result	ALL	ALL	AVE	ALL
	Reliability	OFF	OFF	OFF	OFF
	S.E.	ON	ON	ON	ON
	PD	ON	ON	ON	ON
	ADD	OFF	OFF	OFF	OFF
	KRT print layout	D/mm	D/mm	D/mm	D/mm
	Print form of KRT result	ALL	ALL	AVE	AVE
	KRT ave. -HV or R1R2	R1R2	R1R2	R1R2	HV
	KRT data -HV or R1R2	R1R2	R1R2	R1R2	HV
	KRT average	ON	ON	ON	ON
	KRT cylinder	ON	ON	ON	ON
Cornea diameter	ON	ON	ON	ON	
REF	VD	ON	ON	ON	ON
	Cylinder sign	ON	ON	ON	ON
	Print form of REF result	ALL	ALL	AVE	ALL
	Reliability	OFF	OFF	OFF	OFF
	S.E.	ON	ON	ON	ON
	PD	ON	ON	ON	ON
KRT* <sup>1</sup>	ADD	OFF	OFF	OFF	OFF
	KRT print layout	D/mm	D/mm	D/mm	D/mm
	Print form of KRT result	ALL	ALL	AVE	ALL
	KRT ave. -HV or R1R2	R1R2	R1R2	R1R2	HV
	KRT data -HV or R1R2	R1R2	R1R2	R1R2	HV
	KRT average	ON	ON	ON	ON
KRT cylinder	ON	ON	ON	ON	
Cornea diameter	ON	ON	ON	ON	

\* The date style depends on the "REGION SELECTION OF THE INITIAL STARTUP" (page 25).

America : MDY Europe, General : DMY others : YMD

# PREPARATIONS

## INSTALLATION

 <b>CAUTION</b>	<ul style="list-style-type: none"><li>• When moving the instrument, two people should lift from the bottom of the device. One person lifting the device may cause harm to his back or injury by falling parts.</li><li>• When holding the bottom of the instrument, avoid touching a projection of screws to prevent injuries.</li><li>• To prevent damage and injuries, do not hold the part of anything but bottom. If you hold, it may cause to catch the finger or to damage the instrument by falling.</li><li>• To prevent damage and injuries, do not install the instrument on an uneven, unsteady or sloped surface.</li><li>• When setting an instrument on an instrument table, pay attention not to injury the patient's fingers between the instrument and the table.</li></ul>
--	--

**1** Firmly hold the instrument at the position shown below and place it on the automatic instrument table. For the adjustable instrument table, see "OPTIONAL ACCESSORIES" on page 87.

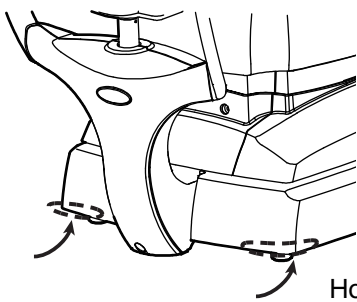

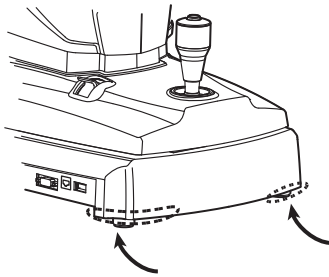

Holding positions



Holding the instrument

## CONNECTING POWER CABLE

 <b>WARNING</b>	<p>Be sure to connect the power plug to an AC 3-pin receptacle equipped with grounding. Connection with receptacle without grounding may cause fire and electric shock in case of short-circuiting.</p>
--	---

 <b>CAUTION</b>	<ul style="list-style-type: none"><li>• To avoid electric shocks, do not handle the power plug with wet fingers.</li><li>• The power cable in standard accessories for this instrument cannot use besides this instrument.</li></ul>
--	--

- 1** Make sure the POWER switch of the instrument is OFF.
- 2** Connect the power cable to the power inlet at the right side of the instrument.
- 3** Insert the power cable plug into the 3-pin AC grounding receptacle.

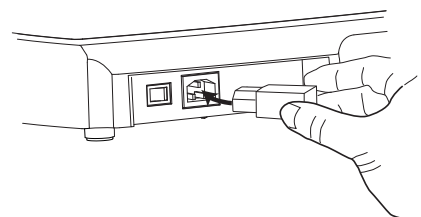



## CONNECTING EXTERNAL I/O TERMINALS



### CAUTION

To avoid electric shock, do not touch the external connection terminal and the patient at the same time.



### NOTE

- When connecting this product with a commercial personal computer, use one conforming to IEC60950-1, with a separation unit.
- Make sure that the setting of this product and the setting of the connected device match.

## DATA OUTPUT

This product can be connected to a personal computer (PC) and other external devices via the RS-232C or LAN.

- 1** Connect the connection cable to the output terminal of the instrument
- 2** Connect the other end of the connection cable to the PC, etc.

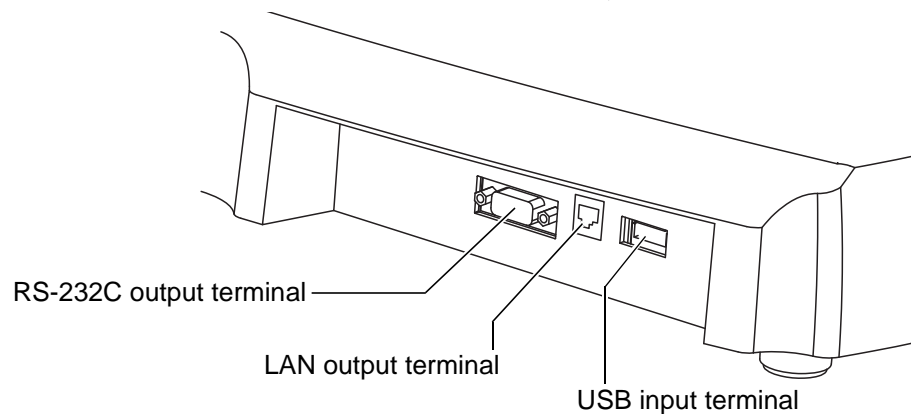

## DATA INPUT



### CAUTION

- Do not operate a touch panel during barcode data entering by barcode reader. If you enter data when tapping the button on the touch panel, the barcode may not be read normally.
- Do not align, measure, or output data during barcode data entering by barcode reader. If you enter data during these operations, the barcode may not be read normally.
- Take care not to enter the wrong patient information. It may be mistaken for information from another patient.

This product can be connected to a barcode reader via USB.

- 1** Connect the barcode reader to the input terminal of the instrument.



### NOTE

For questions about connections, contact your TOPCON dealer.

## **PRINTER PAPER SETTING**



### **CAUTION**

- When setting a printer paper, keep a patient's face away from the instrument. Some part of the instrument may touch the patient's lip or nose if the printer cover open button is pressed.
- To avoid failure or potential injury, do not open the printer cover while the printer is in operation.
- To avoid potential injury in case of malfunction, including a paper jam, be sure to shut off the power before attempting to repair it.
- To avoid potential injury, do not touch the printer body including metal parts or the paper cutter, while the printer is in operation or when replacing the printer paper.



### **NOTE**

- If you insert the printer paper backwards, printing will not start.
- Please push the printer cover OPEN button using your right thumb while placing your index and middle fingers on the projecting part which is in reverse side below the switch. Unexpected movement is avoided when the printer cover OPEN button is pressed.

- 1** Press the printer cover open button to open the printer cover.

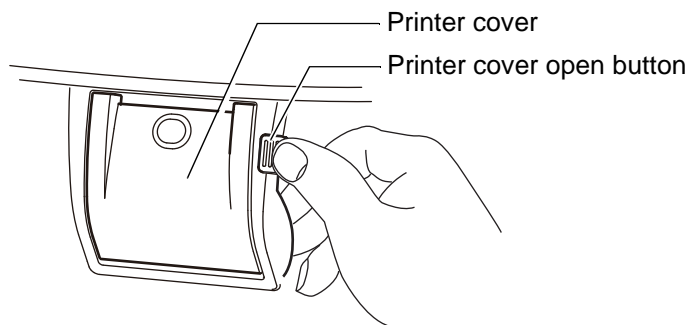

- 2** Open the printer cover to the limit.

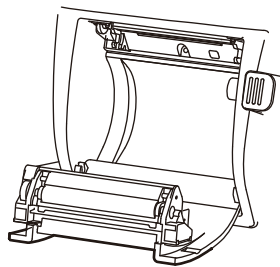

- 3** Insert the printer paper in the direction shown below and pull out the paper end to your side by 7 to 8cm.

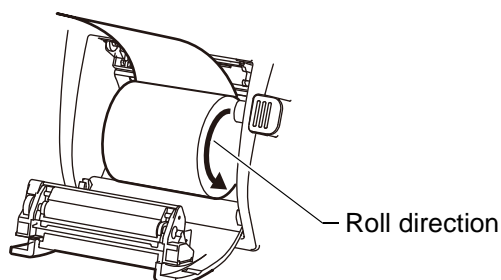

**4** Bring the paper into the center, then close the printer cover.

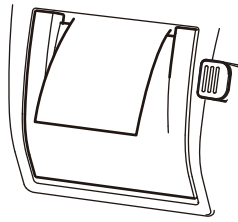

## NOTE

- Please close the printer cover using your right thumb while placing your index and middle fingers on the projecting part which is in reverse side below the printer cover OPEN button. Unexpected movement is avoided when closing the printer cover.
- In case the printer cover is not firmly closed, printing will not start, and "CLOSE PRT COVER" will be displayed on the monitor screen.
- A 58mm wide paper roll (example: TP-50KJ-R [Nippon Paper Co.]) is recommended. Other paper rolls may cause abnormal printing noise or unclear print.

## REGION SELECTION OF THE INITIAL STARTUP

Please select a region in the initial startup of this instrument.



## NOTE

- This operation is done only at initial startup.
- For an area besides America, China, Europe and Japan, please choose the "General".
- The setting of this operation can be reset according to the "resetting region to be used" below.

**1** The region screen appears after displaying the startup screen. Select one from America/China/Europe/Japan/General, and tap the  button.

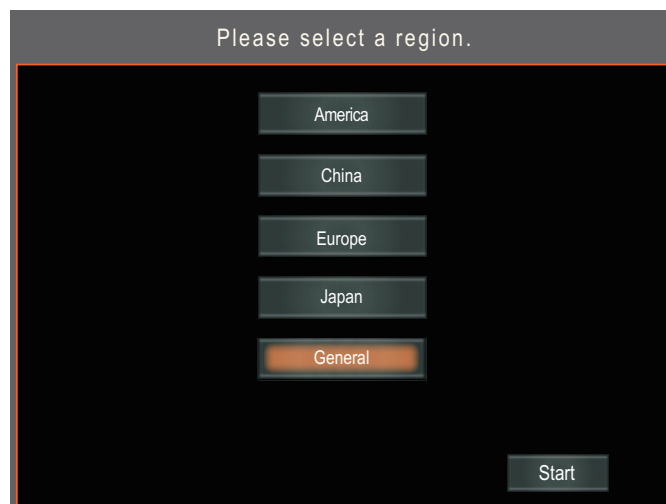

The setting according to the selected region is applied to the instrument.

## RESETTING THE REGION TO BE USED

If resetting the region to be used is required such as by setting the wrong region, perform the following operation.

 <b>NOTE</b>	If the factory default is carried out, clear the setting information of all users.
---	--

- 1 Tap the Settings button of the control panel.



- 2 Select the "Initial".

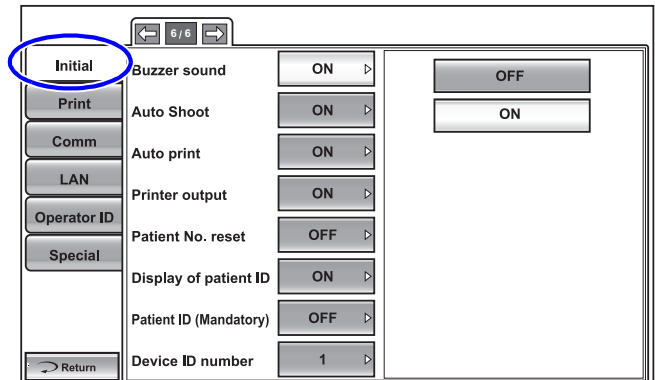

- 3 Display "Factory data Reset"(1) by the Next page button or Back page button, then tap the Execute "Execute"(2).

\*Even if the screen is displayed in a different language or the index is different layout from the illustration, the "Factory data Reset" is always displayed in the bottom index of the "Initial".

- 4 Turn off the power and turn on the power again, you can set the region after starting.

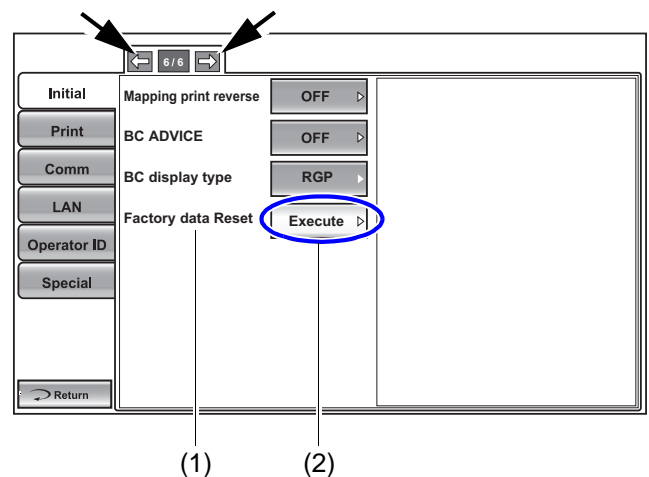

## **RECOVERY FROM POWER SAVE STATUS**

This instrument adopts the power save system for saving electric power. When the machine is not operated for a set time, the touch panel becomes a screensaver.

- 1** Tap the touch panel, operate the control lever or move the base to the left or the right. In a few seconds, the measurement screen is displayed and measurement is enabled.



### **NOTE**

The time to start the power save status can be changed in the initial setting "Start time of sleep mode" (see page 60).

# BASIC OPERATIONS

## PREPARATION BEFORE MEASUREMENT

### TURNING ON THE INSTRUMENT

- 1** Insert the power cable plug into the commercial power (the 3-pin AC grounding receptacle). For the details of connection, refer to "CONNECTING POWER CABLE" on page 22.
- 2** Press on the **POWER** switch.
- 3** Make sure that the title screen is displayed and then the MEASUREMENT screen is displayed in a few seconds.

### SELECTING THE MEASUREMENT MODE

This product has three measurement modes: R/K (REF/KRT continuous measurement), KRT (KRT single measurement) and REF (REF single measurement).

- 1** Check that the MEASUREMENT screen is on.
- 2** Tap the **MEASUREMENT MODE** button on the touch panel and select the measurement mode.

Indication of the **MEASUREMENT MODE** button is changed.

- REF: Only REF measurement
- KRT: Only KRT measurement
- R/K: REF/KRT continuous measurement

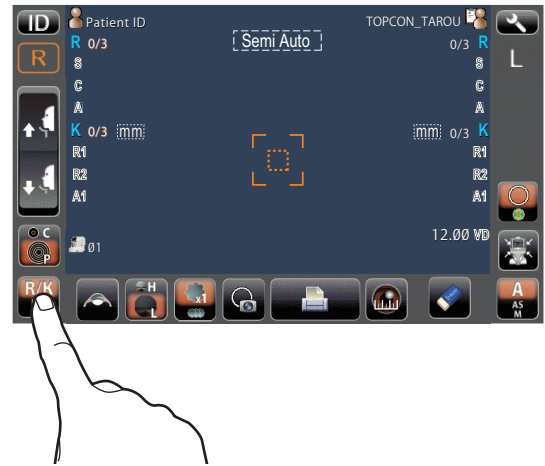

## PATIENT POSITIONING

**CAUTION**

- To avoid injury by moving the instrument, do not press the reset button with the patient's face on the chinrest.
- To avoid electric shock, do not touch the external connection terminal and the patient at the same time.
- To avoid injury, do not insert fingers under the chinrest. To avoid injury when moving the chinrest down, be careful not to catch the patient's finger. Tell this to the patient, too.
- To avoid injury when operating the machine (for measurement and touch panel operation), be careful about the cover not to catch fingers of the patient or operator. Tell this to the patient, too.
- Be careful not to touch the instrument when the patient sits on the chair or stands up. To avoid injury by raising, falling or dropping the instrument, do not apply the strong power downward on the chinrest.
- When operating the instrument (for measurement and touch panel operation), be careful that the instrument does not touch the patient's lip or nose. If touched, clean the instrument following "CLEANING THE FOREHEAD REST AND CHIN REST" on page 69.
- Be sure to bring the main unit closer to the measurement position from the position pulled toward the operator. If you try to align the measurement position from a position close to the patient, the device may hit the patient.

**NOTE**

- Adjust the height of the adjustable instrument table so that the patient can sit on the chair comfortably. Also, make sure that the patient's face is not tilted. Otherwise, correct measurement values may not be obtained.

- 1** Check the measurement screen.
- 2** Take off a chinrest tissue on the chinrest. If the tissue has run out, please supply new chinrest tissues.
- 3** Wipe the dirt form forehead rest.
- 4** Have the patient sit in front of the instrument.
- 5** Adjust the adjustable instrument table or the chair height for the patient to put his/her chin on the chinrest comfortably.

- 6** Hold the control lever, pull the main body towards operator side, place the patient's chin on the chinrest and touch patient's forehead to the forehead rest.

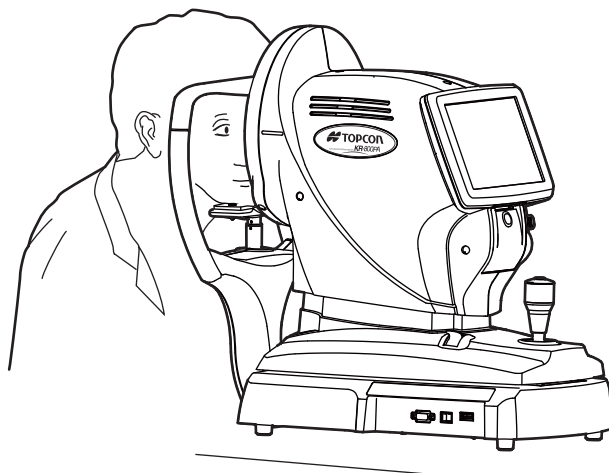

- 7** Adjust the chinrest height by up/down button for chinrest until the eye height mark of the chinrest reaches the same height as the patient's eye. At this moment, confirm that the eye height mark of measuring window is at the height of the patient's visual line.

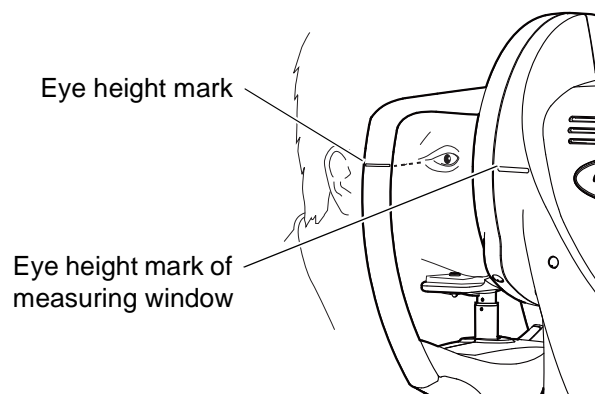



## MEASUREMENT IN SEMI-AUTO MODE

If approaching the automatic measuring range, fine alignment and measurement are performed automatically in Semi-auto mode.



### CAUTION

- When operating the instrument (for measurement and touch panel operation), be careful that the instrument does not touch the patient's lip or nose. If touched, clean the instrument as specified in "CLEANING THE MEASURING WINDOW" on page 69.
- When the operator operates while opening the eyelid of the patient, pay attention to the movement of automatic measurement and make sure that the instrument not hit the hand holding the eyelid. It may injure the patient's eyes and the operator's hands.



### NOTE

- Semi-auto mode measurement may not be possible, in case the eyelid and the eyelashes cover the pupil.  
If this occurs, the operator should tell the patient to open their eyes as wide as possible, or lift the eyelid to allow for measurement.
- Semi-auto mode measurement may not be possible due to frequent blinks or existing abnormalities in the corneal surface caused corneal disease etc. In this case, measure in manual mode.
- If KRT measurement cannot be performed in the REF/KRT continuous measurement mode and cannot shift to the REF measurement, change the measurement mode to REF single measurement mode to perform REF single measurement.

## SETTING THE SEMI-AUTO MODE

**1** If the large sign "A" is displayed in the Alignment mode button with orange background, it is in Semi-Auto mode.

**2** If the large sign "A" is not displayed in the Alignment mode button with orange background, it is in other mode. Tap the button to change to Semi-auto mode.

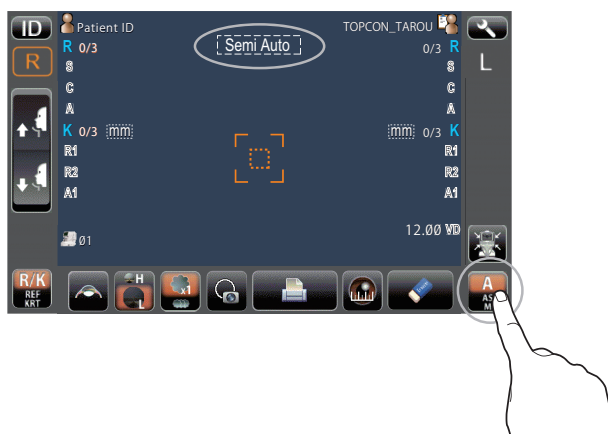

## ALIGNMENT AND MEASUREMENT

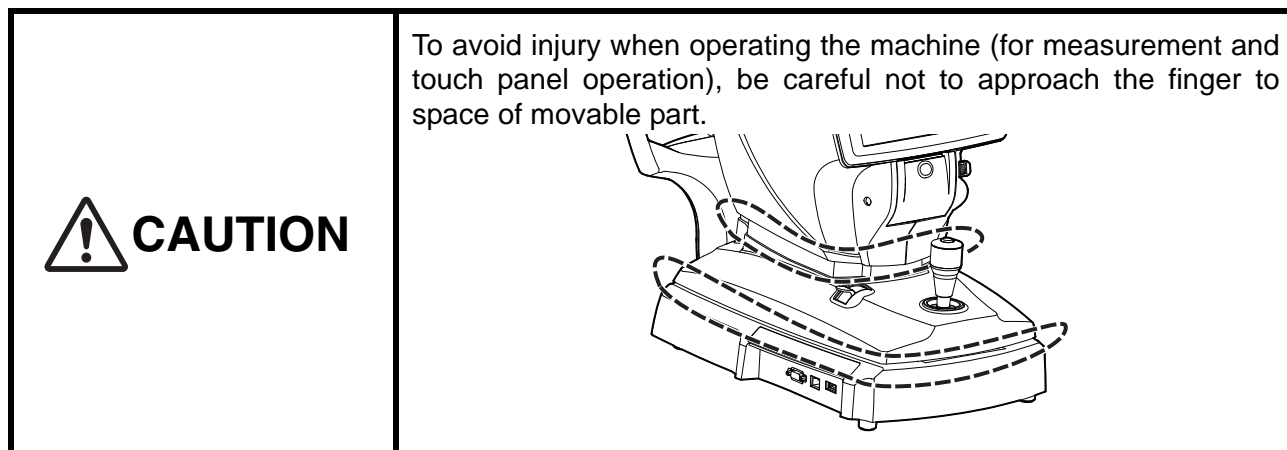

Alignment operations are done with the control lever.

- The main body position can be fine-adjusted longitudinally and laterally by inclining the control level to each direction.

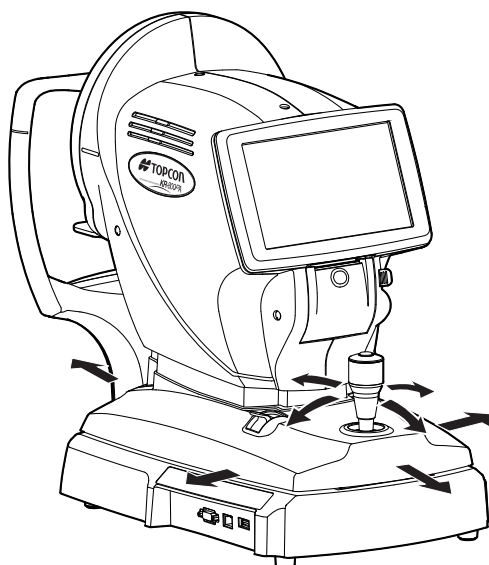

Operating the control lever  
(for front, back, right and left  
adjustment)

- The main body position can be fine-adjusted vertically by turning the control level right (up) and left (down).

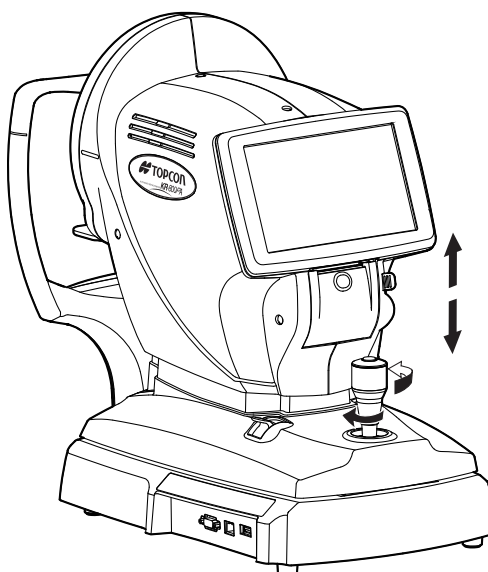

Operating the control lever  
(for up/down adjustment)

- 1 Use the base stopper to release the main body. Hold the control lever and move the main body to the operator side.

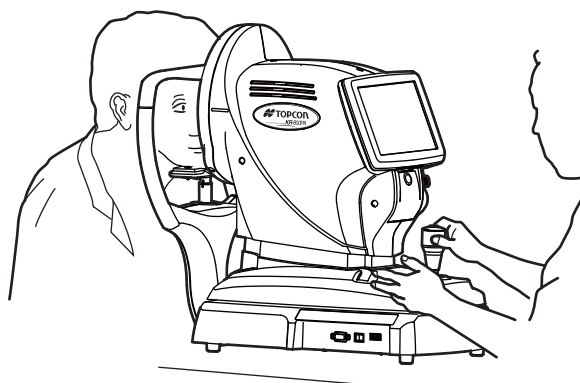

- 2 Operate the control lever laterally and vertically to obtain the target eye in the center of touch panel screen.



- 3 While moving the main body toward the patient, focus the target eye. A vague, reflected alignment dot appears on the cornea.



- 4 Fine-adjust the main body position in all directions so that the alignment dot point comes within the alignment mark.

**5** Keeping the alignment dot within the alignment mark, slowly move the main body toward the patient. When the main body approaches the target eye, Z alignment arrows appear to the touch panel screen.



Z alignment arrows

**NOTE** Do not allow the eyelash and eyelid to cover outer alignment mark to ensure stable measurement.

- If the machine is too close to the patient's eye in comparison with the optimal alignment position, outward Z alignment arrows appear in magenta (red purple) color, or it is too far the inward arrows appear in cyan (blue) color.

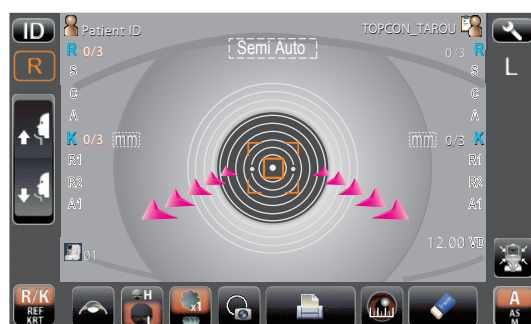

**6** Move the measuring head to the direction of the arrows indicated by operating the control lever. The automatic alignment starts.

When the measuring head has reached the limit of movement (vertical/lateral directions), a yellow-colored limit mark appears on the touch panel corner, showing it is the movement limit in that direction and the message of "MOVE \*\*\* TO AVOID LIMIT." displayed. Move the measuring head or the chinrest to a position that aligning is possible.

**NOTE**

Limit mark

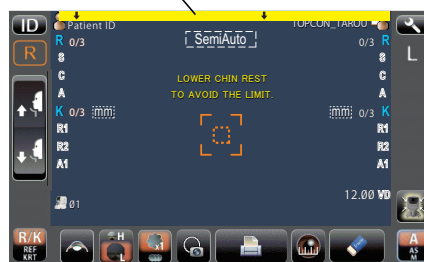

In the limit of depth direction, only the message "MOVE FORWARD (BACKWARD) TO AVOID THE LIMIT." is displayed.

## NOTE

Eyelid function: The more stable measured value can be obtained by using this function.

When an eyelid and eyelashes cover the patient's pupil, the beep sound comes and the message of "Check eyelid." is displayed by the eyelid function. Measurement operation is not performed while the message is displayed. If this occurs, the operator should tell the patient to open their eyes as wide as possible, or lift the eyelid with care not to push the patient's eye.

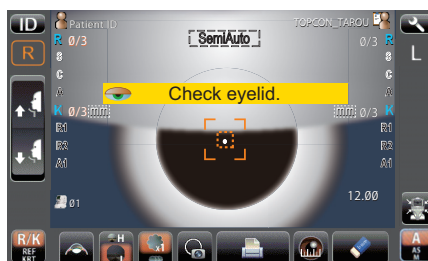

- The eyelid function can be selected to ON or OFF. (See page 61)
- Even if the eyelid is not lifted within the set time, automatic measurement starts forcibly in the present condition. The set time (Eyelid Force Meas. time) can be changed. (See page 61)

**7** If automatic alignment starts, the measuring head moves automatically. Alignment and the measurement for the set measurement count are performed automatically. The measurement value is displayed on the monitor screen.

**8** After one eye measuring is finished, pull the control lever forward once, and then slide to the crosswise direction to switch the measured eye. Repeat the same procedure to measure the other eye of the patient in sequence.



## NOTE

- If Semi-Auto mode measurement does not work, select manual mode. Auto Shoot mode measurement may not work depending on the cornea condition
- Under Semi-auto mode, it is possible to switch to Manual mode by pushing the Measurement button.
- If the machine is moved before measurement values are displayed, it might cause an incorrect measurement.
- Auto print (available only under Semi-Auto mode and Auto shoot mode) When the "Auto print" is set to "ON" in the initial setting, measurement results are printed out automatically after measuring the right and left eyes. When the "Auto print" is set to "OFF" in the initial setting, measurement results are printed out by tapping the print button, if required.

## DISPLAYING MEASUREMENT VALUES

Data of the latest measurement are displayed on the touch panel screen.

Figures only: Measurement was done correctly.

ERROR: Measurement was not done correctly.



### NOTE

For explanation of the messages on the touch panel screen, refer to "MESSAGE LIST" on page 71.

## MEASUREMENT IN AUTO SHOOT MODE

In Auto shoot mode the process to fine alignment is performed manually, and the measurement starts automatically if reaching the measurable range.



### CAUTION

- When operating the instrument (for measurement and touch panel operation), be careful that the instrument does not touch the patient's lip or nose. If touched, clean the instrument as specified in "CLEANING THE MEASURING WINDOW" on page 69.
- When the operator operates while opening the eyelid of the patient, pay attention to the movement of automatic measurement and make sure that the instrument not hit the hand holding the eyelid. It may injure the patient's eyes and the operator's hands.



### NOTE

- Auto Shoot mode measurement may not be possible, in case the eyelid and the eyelashes cover the pupil. If this occurs, the operator should tell the patient to open their eyes as wide as possible, or lift the eyelid to allow for measurement.
- Auto Shoot mode measurement may not be possible due to frequent blinks or existing abnormalities in the corneal surface caused corneal disease etc. In this case, select manual mode.
- Under Auto shoot mode, it is possible to switch to Manual mode by pushing the Measurement button.

## SETTING THE AUTO SHOOT MODE

# 1

If the large sign "AS" is displayed in the Alignment mode button with orange background, it is in Auto shoot mode.

- 2** If the large sign "AS" is not displayed in the Alignment mode button with orange background, it is in other mode. Tap the button to change to Auto shoot mode.

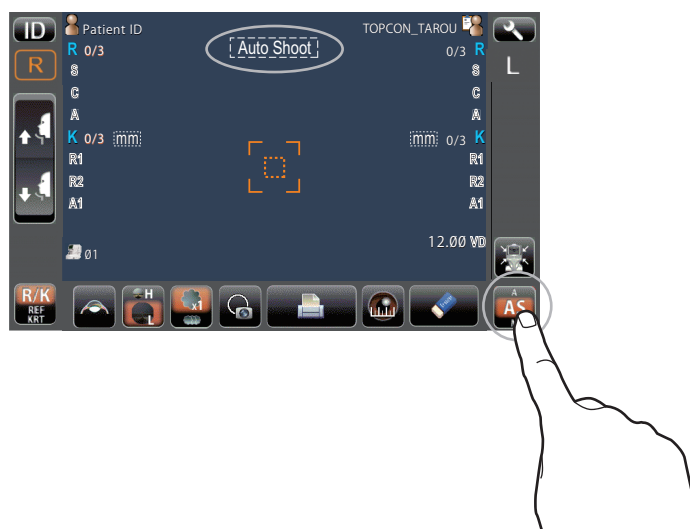

## ALIGNMENT AND MEASUREMENT

- 1** Align as same manners for **5** at "ALIGNMENT AND MEASUREMENT" (page 32) in Semi-auto mode, until the Z alignment arrows appear.



- 2** Move the measuring head to the direction of the arrows indicated by operating the control lever. The number of arrows is reduced accordingly as the measuring range comes closer.



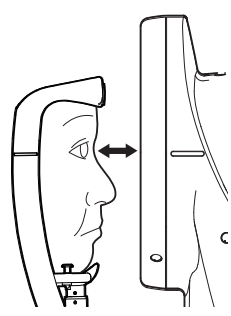

Too close

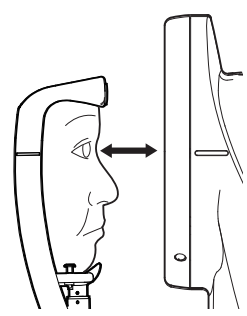

Too far

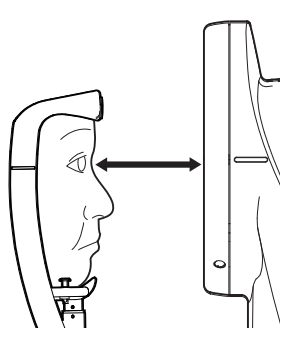
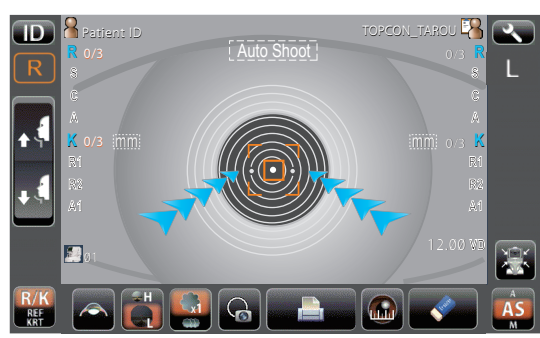

Positioning is incorrect at all.



- 3** When reaching the measurable range, the measurement is carried out automatically at the position which the alignment mark turns green. The measurement value is displayed on the touch panel.
- 4** After one eye measuring is finished, pull the control lever forward once, and then slide to the side direction to switch the measured eye. Repeat the same procedure to measure the other eye of the patient in sequence.

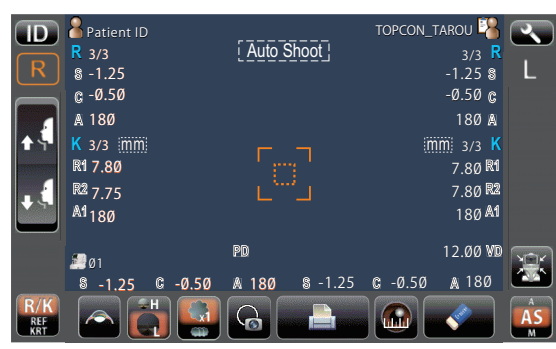



## DISPLAYING MEASUREMENT VALUES

Data of the latest measurement are displayed on the touch panel screen.

Figures only: Measurement was done correctly.

ERROR: Measurement was not done correctly.



### NOTE

For explanation of the messages on the touch panel screen, refer to "MESSAGE LIST" on page 71.

## MEASUREMENT IN MANUAL MODE

In manual mode all processes are performed manually from alignment to measurement.

### SETTING THE MANUAL MODE

- 1** If the large sign "M" is displayed in the Alignment mode button with orange background, it is in Manual mode.
- 2** If the large sign "M" is not displayed in the Alignment mode button with orange background, it is in other mode. Tap the button to change to Manual mode.

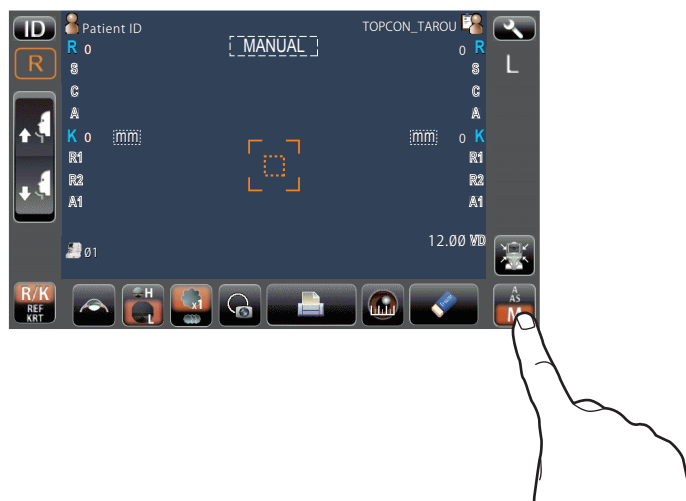

### ALIGNMENT AND MEASUREMENT



#### NOTE

If the pupil is not displayed on the touch panel, move the measuring head, checking the eye height mark on the measurement window as a guide (see page 30).

- 1** Align to make the alignment dot within the alignment mark as same manner of **1** at "ALIGNMENT AND MEASUREMENT" (page 37) in Auto shoot mode, until the Z alignment arrows appear.
- 2** Move the measuring head to the direction of the arrows indicated by operating the control lever. The number of arrows is reduced accordingly as the measurable range comes closer.



- 3** The alignment mark turns green at the position which the cyan (blue) or magenta (red purple) Z alignment arrows reach minimum. When "ALIGNMENT OK" is displayed, push the **MEASUREMENT button**.



## NOTE

- Do not allow the eyelash and eyelid to cover the outer alignment mark to ensure stable measurement.
- Even if fine alignment has not been achieved, measurement can be performed by pressing the **MEASUREMENT button**. To ensure correct measurement, try to get fine alignment.

- 4** The measurement is carried out automatically and the measurement value is displayed on the touch panel.



## NOTE

If the machine is moved before measurement values are displayed, it may cause incorrect measurement result.

- 5** After one eye measuring is finished, pull the control lever forward once, and then slide to the crosswise direction to switch the measured eye. Repeat the same procedure to measure the other eye of the patient in sequence.



## DISPLAYING MEASUREMENT VALUES

Data of the latest measurement are displayed on the touch panel screen.

Figures only: Measurement was done correctly.

ERROR: Measurement was not done correctly.



## NOTE

For explanation of the messages on the touch panel screen, refer to "MESSAGE LIST" on page 71.

## MEASUREMENT IN PERIPHERAL MEASUREMENT MODE

It is possible to measure the radius of curvature or the corneal refractive power of the corneal periphery ( $\phi$  6.6 mm: R 7.7 mm), by performing the peripheral measurement.

### PREPARATION FOR THE PERIPHERAL MEASUREMENT

**1** On the measurement screen, check that the  button is displayed as "R/K" or "KRT" large.

**2** If the  button is displayed as "REF" large, tap to switch to "R/K" or "KRT".

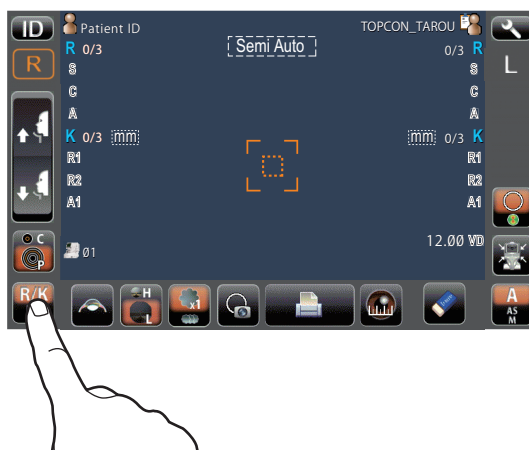

**3** If the  button is "C" , it is in the state of center KRT measurement.

Tap to switch to the state "P"  of the peripheral KRT measurement.

**4** Measure in one of modes of semi-auto, auto shoot or manual. (See "MEASUREMENT IN SEMI-AUTO MODE" on page 31, "MEASUREMENT IN AUTO SHOOT MODE" on page 36, or "MEASUREMENT IN MANUAL MODE" on page 40)

**5** After the measurement, the periphery data mark is displayed on the screen. The display position is the lower left of the screen in the case of the right eye (R) and the lower right of the screen in the case of the left eye (L).





- The number and arrangement of the squares constituting the periphery data mark will differ depending on the setting in "Initial" "Peripheral point" on the setting screen.

 : When "9 points" is set

 : When "5 points" is set

- It is possible to judge whether effective data can be acquired at each measurement point or not by displaying each square constituting the periphery data mark.

 : Display valid data

 : Display invalid data





## NOTE

- The display of the periphery data mark is not the last data of the continuous measurement, but it indicates whether it is valid or invalid depending on the typical value.
- When all measurement points are invalid data, the periphery data mark is not displayed.

## MAPPING MEASUREMENT

It is possible to observe the distribution of corneal radius of curvature or corneal refractive power by performing mapping measurement.

### PREPARATION FOR THE MAPPING MEASUREMENT

- 1** On the measurement screen, check that the Measurement mode button is displayed as "R/K" or "KRT" large.
- 2** If the Measurement mode button is displayed as "REF" large, tap to switch to "R/K" or "KRT".
- 3** Check the measurement screen, if the R/K  $\leftrightarrow$  Mapping change button is  (mapping function OFF), tap to switch to  (mapping function ON).



- 4** Measure in one of modes of semi-auto, auto shoot or manual. (See "MEASUREMENT IN SEMI-AUTO MODE" on page 31, "MEASUREMENT IN AUTO SHOOT MODE" on page 36, or "MEASUREMENT IN MANUAL MODE" on page 40)
- 5** After the measurement, the result of mapping measurement is displayed.

\* When continuous measurement is performed in semi-auto mode or auto shoot mode, the last KRT measurement image is used as mapping measurement result.

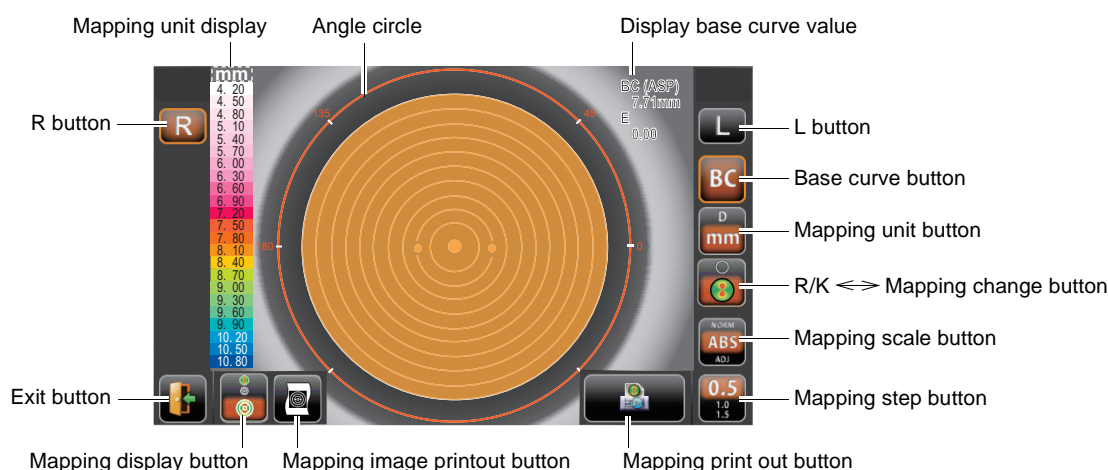

- 
 R button/L button.....Switches mapping screen for right eye or left eye. The selected button L or R is framed in orange.
  
-  Exit button .....Exits mapping screen and return to the measurement screen.
  
-  Mapping display button .....Switches mapping display mode.  
 Mapping:  
 An opaque map is displayed overlaying on the anterior display.  
 Anterior: Only the anterior image is displayed.  
 Overlay:  
 A semi-transparent map is displayed overlaying on the anterior display.
  
-  Mapping print out button.....Prints out mapping image and measurement results.
  
-  Mapping image printout button .....Print out only the mapping image.
  
-  BC display button .....Display base curve value.  
 To display the base curve value, you can select RGP or ASP according to the "Initial" "BC display type" settings on the settings screen.
  
-  Mapping unit button .....Switches the display unit to Diopter or mm.
  
-  R/K  $\leftrightarrow$  Mapping change button .....In the data output, select whether to include mapping  or not include  .
  
-  Mapping scale button .....NORM: Relative value scale  
 The center of the scale is automatically determined based on the measurement result, and it is output in accordance with the mapping step.  
 ABS: Absolute value scale  
 The scale display range is fixed at 34.5D to 67.5D, and it is output with the fixed 1.5D of the mapping display step.  
 ADJ: Adjustable relative value scale  
 It is a relative value scale which can change the center value of the color code and the display step.
  
-  Mapping step button .....The mapping step can be selected from 0.5 D (0.1 mm), 1.0 D (0.2 mm) 1.5 D (0.3 mm).

 **NOTE** For detailed setting of mapping measurement result display, refer to "Initial" on the settings screen (pages 60 to 62).

**6** If the continuous measurement of the other eye is required, pull the control lever to the front and then slide sideways to automatically return to the measurement screen.

## PRINT-OUT OF MEASUREMENT VALUES



### NOTE

- To avoid a paper jam in the printer, do not feed the paper if it is partly cut or wrinkled.
- To avoid discoloring of the printer paper (particularly the recording area) during storage, use a polypropylene bag and not one containing plasticizer (PVC, etc.).
- To avoid discoloring of the printer paper (particularly the recording area) after pasting, use water-soluble glue and not one containing solvent.
- Since the printer paper is thermosensitive, it is not suitable for keeping records for a long period. If necessary, prepare copies separately.

This instrument can print out measurement values by a printer.

# 1

Check the Measurement screen is on.

# 2

Tap the **PRINT OUT** button on the touch panel.

Measurement values on the monitor are printed out.

After being printed out, the measurement values on the screen are deleted automatically.

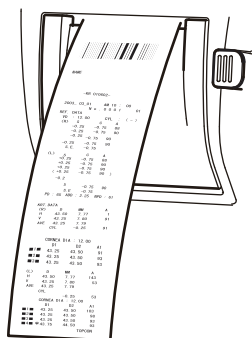

### NOTE

- When the cylindrical refractive power is "0," the direction of cylindrical axis and measurement values are not displayed/printed.
- When a red line is printed at the end of the printer paper, replace it with a new one. For details about the replacement of printer paper, see "PRINTER PAPER SETTING" on page 24. 58mm wide printer paper (example: TP-50KJ-R, Nippon Paper) is recommended.
- "CLOSE PRT COVER" is indicating that the printer cover is left opened, ensure that the printer cover is completely closed.
- When auto print is setting is "ON" in the initial setting, measurement is performed under Auto mode, and measurement results are printed out automatically. (See page 60.)
- When the Auto cut setting is off and you need to cut a printer form, the way is that erase the measurement value by tapping the **ALL CLEAR** button, and tap the **PRINT OUT** button. (See page 63.)



## MEASUREMENT IMAGE OBSERVATION

It is possible to observe the measurement images of REF and KRT each.

### MEASUREMENT IMAGE OBSERVATION

- 1 Tap the **TARGET IMAGE** button after measuring in R/K or KRT mode.

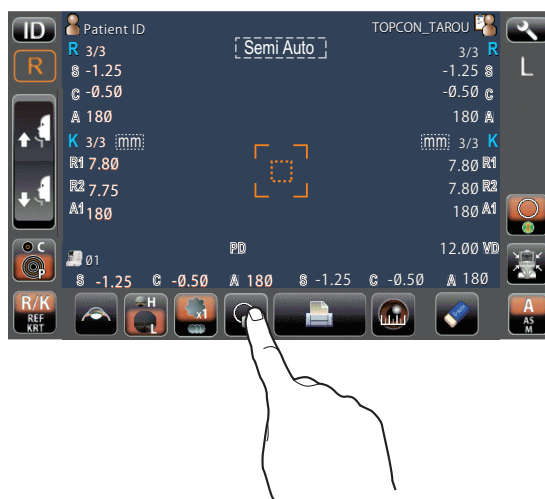

KRT image is displayed.

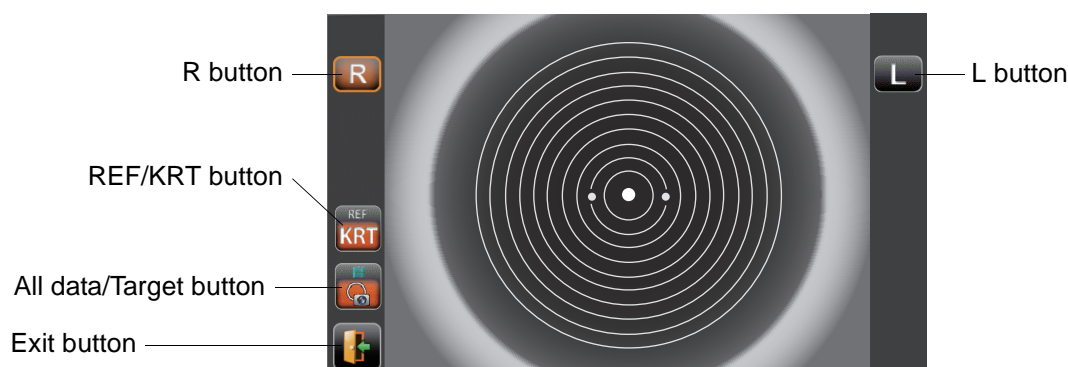

- 2 Tap the **R** button or **L** button to switch to the right eye or left eye measurement image and observe it.
- 3 In R/K mode, the REF image can be observed by tapping the **REF/KRT** button.
- 4 Tap the **EXIT** button and return to the Measurement screen.

## DISPLAYING ALL MEASUREMENT DATA

Normally the latest measurement is displayed, but it is possible to display and confirm all measurement data. Measurement data chooses and displays "REF data" and "KRT data".

- 1 Tap the **TARGET IMAGE** button of the touch panel.

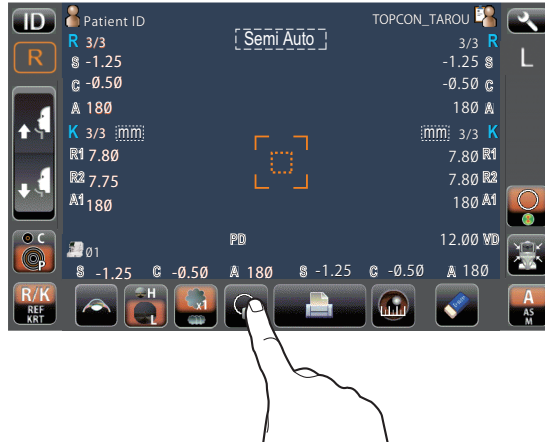

- 2 Tap the **ALL DATA / TARGET** button.

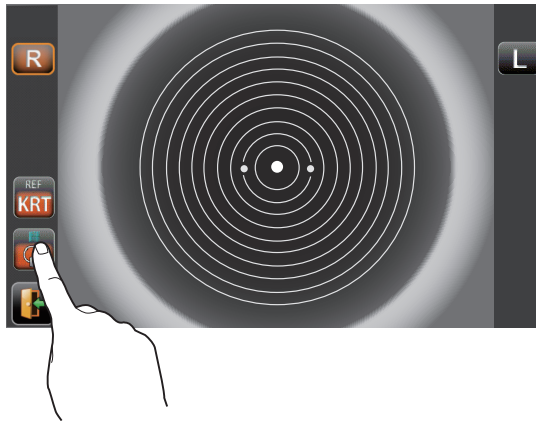

- 3 The Data Display screen is displayed.

RIGHT				LEFT			
	S	C	A		S	C	A
C1	-1.25	-0.50	180	1	-0.25	-0.50	180
2	-1.25	-0.50	180	2	-0.25	-0.50	180
(3)	-1.25	-0.50	180	3	-0.25	-0.50	180
4				4			
5				5			
6				6			
7				7			
8				8			
9				9			
10				10			
AVE	-1.25	-0.50	180	AVE	-0.25	-0.50	180

When measurement is performed with the Cataract button ON, "C" comes at the head of figures.

When Cataract mode starts automatically during the measurement, figures will be put in ( ).

RIGHT				LEFT			
	S	C	A		S	C	A
C1	-1.25	-0.50	180	1	-0.25	-0.50	180
2	-1.25	-0.50	180	2	-0.25	-0.50	180
(3)	-1.25	-0.50	180	3	-0.25	-0.50	180
4				4			
5				5			

**NOTE** When no data is memorized, the data table shows blank.

**4** To change "REF data" and "KRT data," tap the **REF/KRT** button.

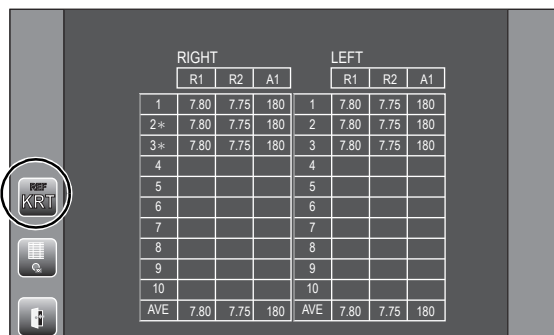

When the reliability of KRT data is low, "\*" is attached after the figures.

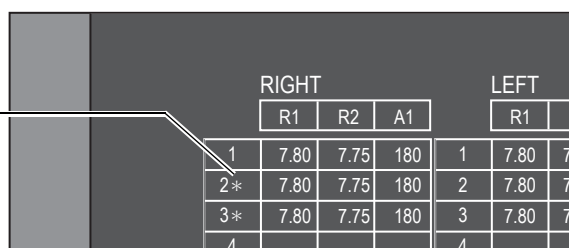

**5** To exit the data display and return to the Measurement screen, tap the **EXIT** button.

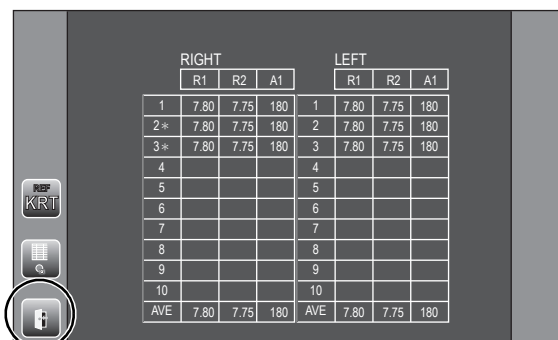

## CLEARING MEASUREMENT VALUES

- 1 Tap the **ALL CLEAR** button on the touch panel.  
All measurement values of both eyes are cleared.

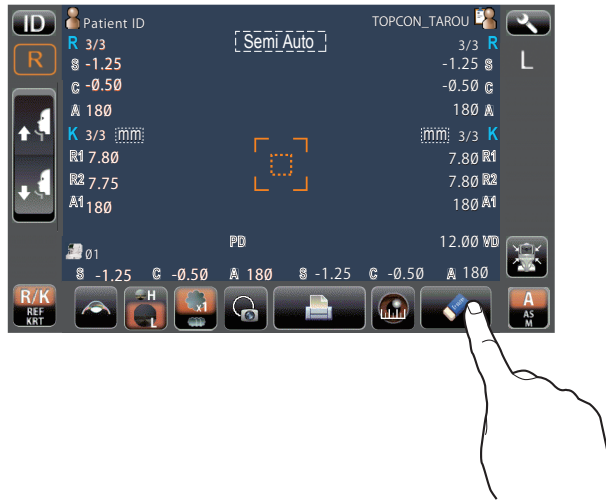

## OPERATION OF AFTER USE

- 1 Use the base stopper to fix the main body.
- 2 Turn the **POWER** switch to off.

 <b>NOTE</b>	When external devices are connected to external I/O terminals, turn off the power of these devices too. (If power switch is provided.)
---	---

- 3 Unplug the power cable from a 3-pin AC inlet with grounding.

 <b>NOTE</b>	When the instrument is not used for a long period, unplug the power supply cable, and detach the cable connected to the external I/O terminal.
---	--

# OPTIONAL OPERATIONS

## DISPLAYING THE PATIENT ID (PATIENT No.) OR OPERATOR ID

A patient ID or operator ID of up to 13 characters can be input and displayed on the touch panel and printout.

However, if no patient ID is input, the patient No. is allocated automatically by the device.

- 1 Tap **ID** button.
- 2 Tap keyboard on the screen and enter characters. Tap **OK** button and fix the input value.

 <b>NOTE</b>	<ul style="list-style-type: none"> <li>Patient ID is reset when measurement values are printed or if the <b>ALL CLEAR</b> button is tapped.</li> <li>Patient No. reset condition can be selected such that the patient No. is reset upon power on or not, in the initial setting of setup screen. "Refer to "Patient No. reset" on page 60.</li> <li>Be sure to verify the input ID to agree with data of a patient or an operator.</li> </ul>
---	--

## MEASUREMENT OF CORNEA DIAMETER

### MEASUREMENT ON THE ACTUAL IMAGE

- 1 Tap the **CORNEA DIAMETER** button.



- 2 The Cornea Diameter Measurement screen is displayed, and the positioning bar is displayed.

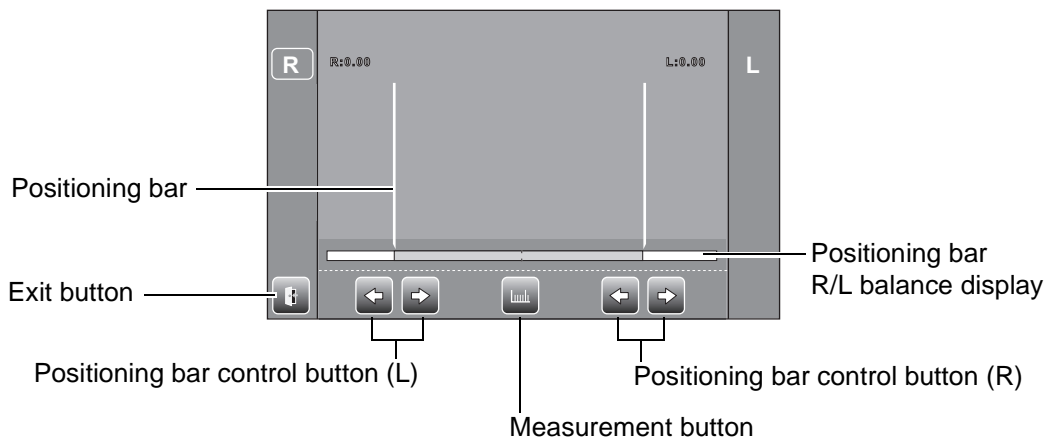

- 3 When the pupil is displayed, moves the measuring head so that the pupil image and alignment dot are at the center of the screen.
- 4 Using the **POSITIONING BAR CONTROL** button (L), move the left positioning bar to the left end of the iris from the touch panel side.

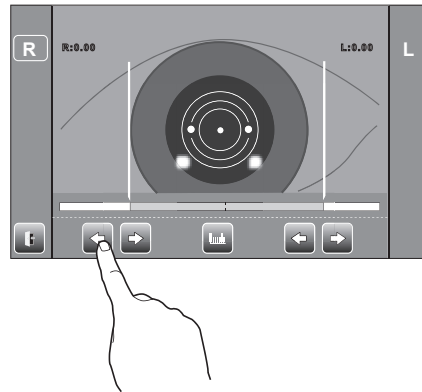

- 5 Using the **POSITIONING BAR CONTROL** button (R), move the right positioning bar to the right end of the iris from the touch panel side.

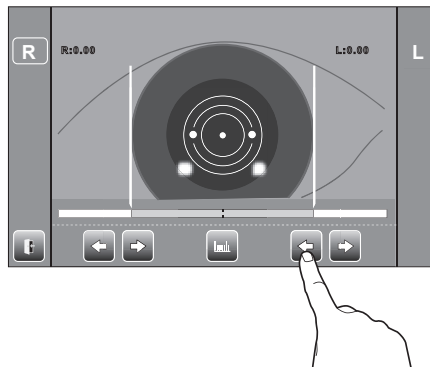

	<p><b>NOTE</b> By tapping the positioning bar R/L balance display, positioning bar can be moved.</p>
---	--

- 6 Tap the **MEASUREMENT** button.
- 7 The cornea diameter is displayed.

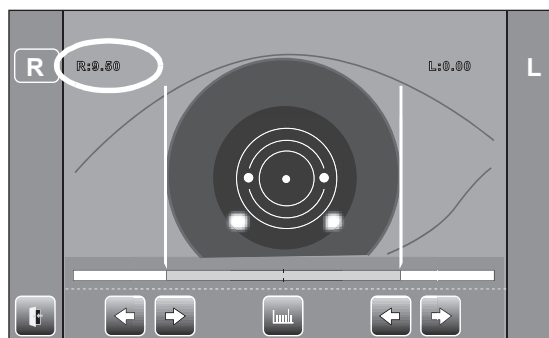

- 8 Move the measuring head to the other eye measurement position. In like manner, measure the other eye.
- 9 Tap the **EXIT** button and return to the Measurement screen.

## MEASUREMENT ON THE STILL IMAGE

When KRT measurement values are available, the still image of the measurement is displayed.

- 1 Follow steps 1 to 3 of "MEASUREMENT ON THE ACTUAL IMAGE" and display the cornea image at the screen center.
- 2 Press the **MEASUREMENT button** to display the saved image.

 <b>NOTE</b>	If you are required to get the still image again, press the <b>MEASUREMENT button</b> to return to actual image, and press the <b>MEASUREMENT button</b> again.
---	---

- 3 Tap either of the (R)/(L) **POSITIONING BAR CONTROL** buttons and move the positioning bar.

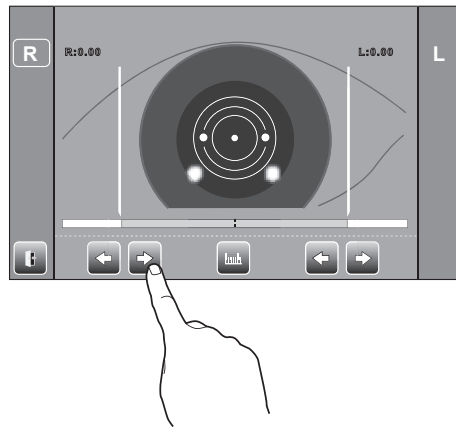

- 4 Follow steps 4 to 6 of "MEASUREMENT ON THE ACTUAL IMAGE."
- 5 The cornea diameter is displayed.

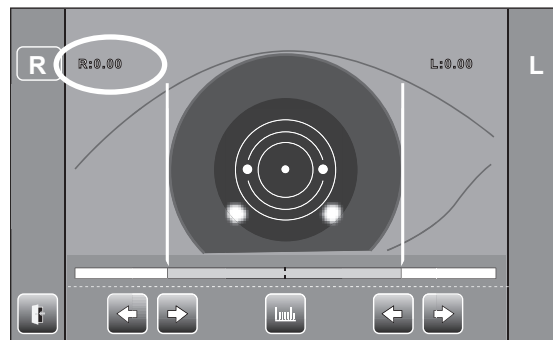

- 6 Move the measuring head to the other eye measurement position. In like manner, measure the other eye.
- 7 Tap the **EXIT** button and return to the Measurement screen.

## MEASUREMENT OF HARD CONTACT LENS

- 1** Confirm that it is in the corneal shape measurement (R/K mode or KRT mode). Alternatively, tap the Measurement mode button on the touch panel and select the measurement mode.
- 2** Place water in the concave part at the tip of the contact lens holder of the attached model eye and affix the contact lens to be measured.
  - It sticks by surface tension.
  - Avoid bubbles inside.
  - Do not allow water to adhere to the measuring surface of the contact lens.

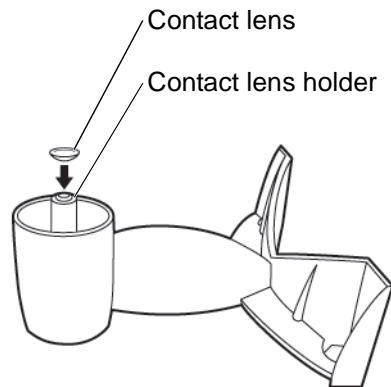

- 3** Insert the attached model eye into the chinrest tissue pin.

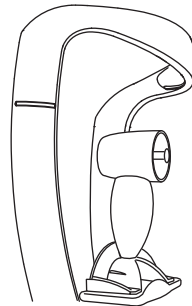

- 4** Below, measure it like the cornea curvature radius measurement.

\* In the case of measuring the base curve (concave) of the contact lens, the axis angle is opposite to that of the usual corneal curvature radius measurement (convex part).



## **OUTPUT USING RS-232C**

This instrument can output data to a PC, etc. via the RS-232C interface.

- 1** Connect the interface cable to RS-232C OUT.  
Refer to "CONNECTING EXTERNAL I/O TERMINALS" on page 23.
- 2** Set up of data communication settings.  
For details, refer to "DATA COMMUNICATION (COMM)" on page 65.
- 3** Perform measurements.
- 4** Tap the **PRINT OUT** button of the touch panel.  
When output is completed, "RS-232C SUCCESS" is displayed on the screen.

## **INPUT USING USB**

This instrument can input ID numbers from a barcode reader via the USB.

- 1** Check the connection of USB IN.  
For connection, refer to "CONNECTING EXTERNAL I/O TERMINALS" on page 23.
- 2** Input ID numbers from the barcode reader.  
The inputted ID numbers are displayed on the screen.

## **OUTPUT USING LAN**

This instrument can output data to a PC, etc. via the LAN interface.

- 1** Connect the network cable to LAN OUT.  
For connection, refer to "CONNECTING EXTERNAL I/O TERMINALS" on page 23.
- 2** Set up of LAN connection settings.  
For details, refer to "LAN CONNECTION (LAN)" on page 66.
- 3** Perform measurements.
- 4** Tap the **PRINT OUT** button of the touch panel.  
When output is completed, "LAN SUCCESS" is displayed on the screen.



### **NOTE**

For explanation of messages during communication refer to the "MESSAGE LIST" on page 71.

# SETTING FUNCTIONS ON SETUP SCREEN

## OPERATING THE SETUP SCREEN

Various functions can be set on the SETUP screen.

### PREPARATIONS FOR SETTING

- 1 Make sure that the power cable is connected.  
For connection, refer to "CONNECTING POWER CABLE" on page 22.
- 2 Turn ON the  POWER switch.
- 3 Tap the  SETTINGS button on the touch panel.

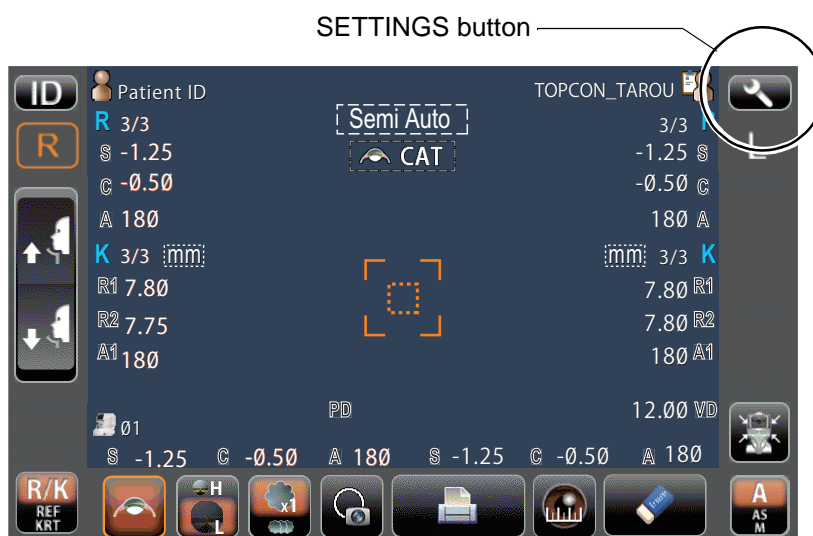

The SETUP screen is displayed.

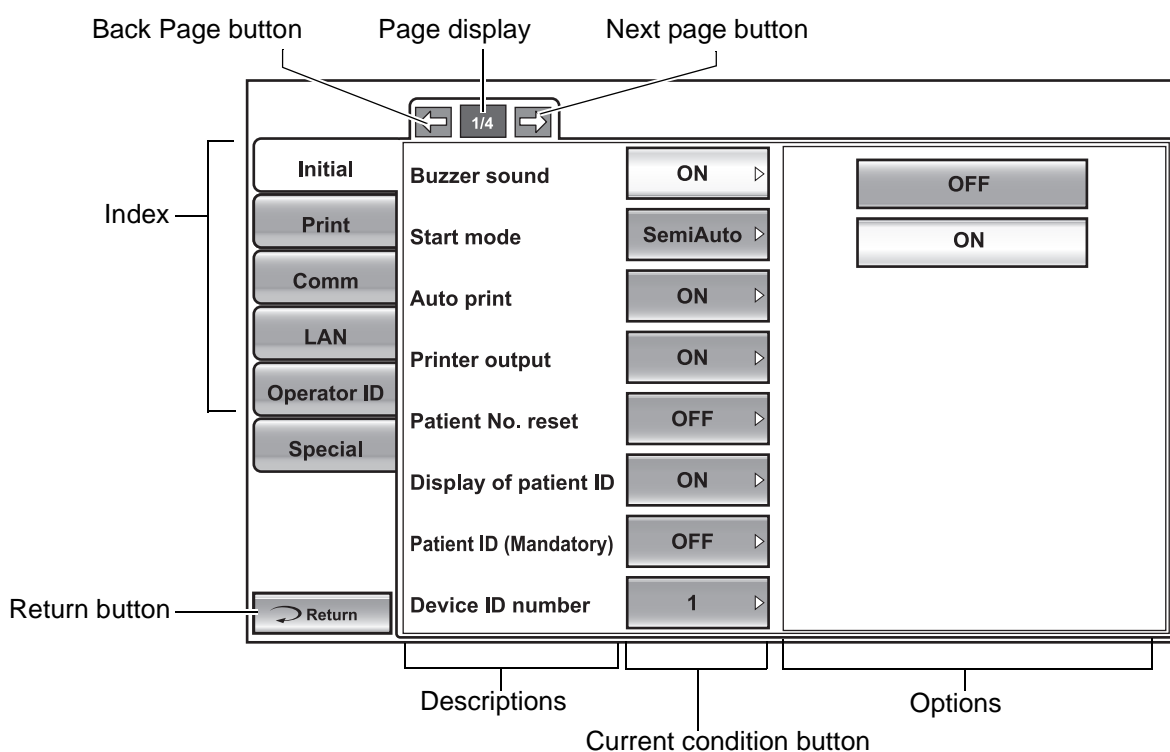

## OUTLINE OF SETUP SCREEN OPERATIONS

**1** Tap **INDEX** and select the subject of setting.

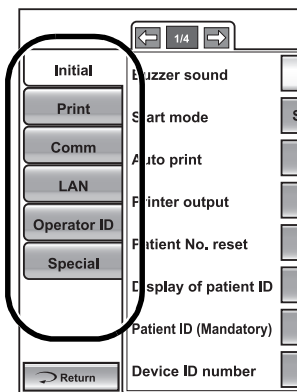

**2** Operate the **NEXT PAGE** button or **BACK PAGE** button, as necessary, and display the page to confirm/change.

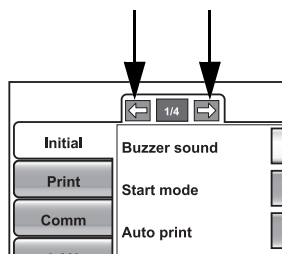

**3** Tap the **CURRENT CONDITION** button of the item to be changed and find the **OPTIONS** button.

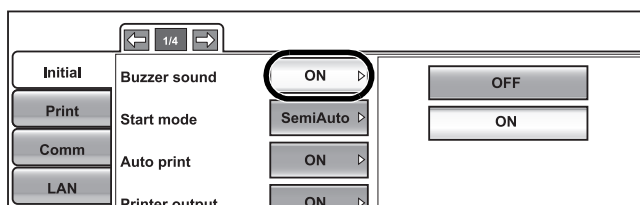

**4** Tap the **OPTIONS** button and change the setting.

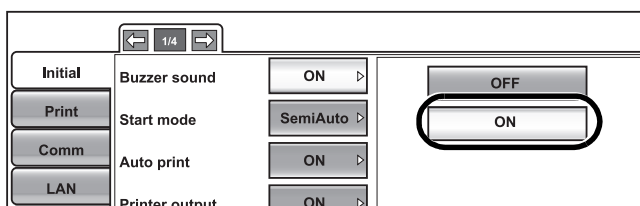

- Instead of the **OPTIONS** button, ten-key and keyboard would be displayed.

### TEN-KEY:

Tap ten-key on the screen and enter the figure. If there are several windows to enter, tap the window to enter the figure by ten-key. Tap **OK** and fix the input value.

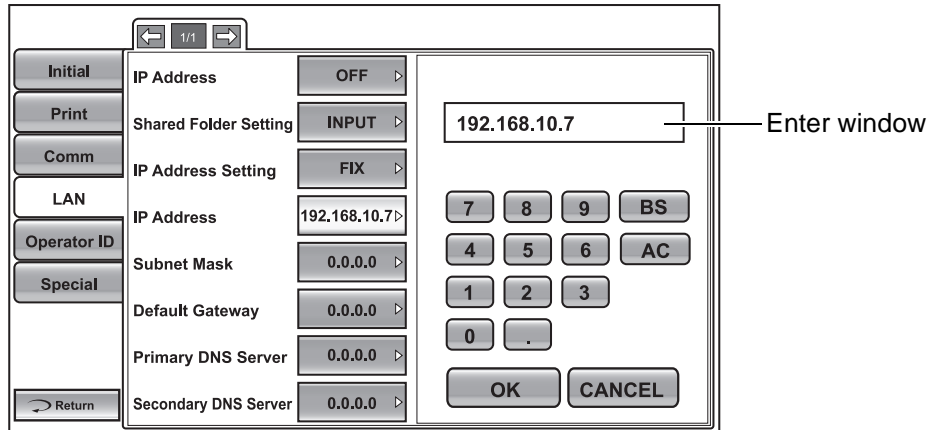

### KEYBOARD:

Tap keyboard on the screen and enter characters. If there are several windows to enter, tap the window to enter the figure by keyboard. Tap **OK** and fix the input value.

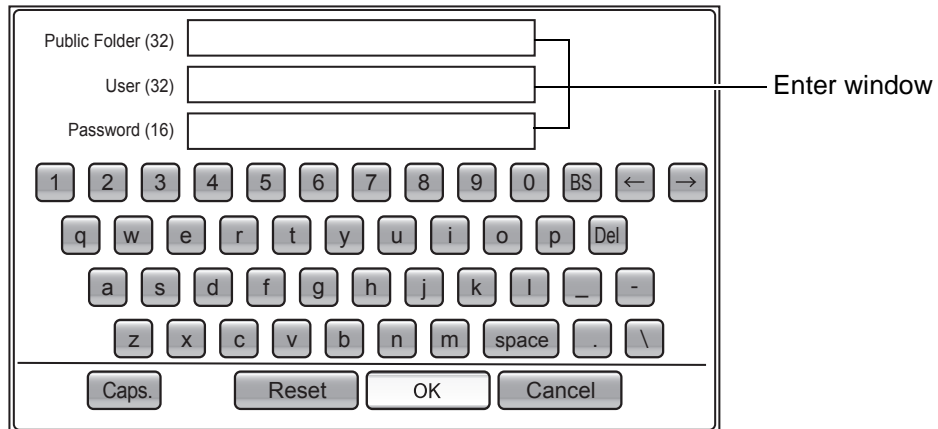

## RETURNING TO THE MEASUREMENT SCREEN

1 Tap the **Return** button.

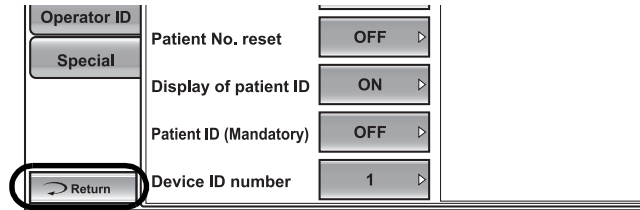

2 The Measurement screen is displayed.



## LIST OF SETUP ITEMS

Setup items are categorized into 6 large indexes.

- "Initial" .....items related to the initial status after power on
- "Print" .....items related to output from the internal printer
- "Comm" .....items related to data output with the external device
- "LAN" .....items related to output using the LAN
- "Operator ID" .....items related to Operator ID
- "Special" .....items related to maintenance (for service engineer only)

### INITIAL (INITIAL SETTING)

Initial contains settings related to the initial status after power on, clearing all measurement values, etc.

Descriptions	Options	Details	Initial value (Region)				
			A	C	E	J	G
Buzzer sound	OFF	Buzzer does not sound.					
	ON	Buzzer sounds.			✓		
Start mode	Manual	Default start mode is set to Manual.					
	AutoShoot	Default start mode is set to Auto Shoot.					
	SemiAuto	Default start mode is set to Semi-Auto.				✓	
Auto print*	OFF	Not printed automatically.				✓	
	ON	After AUTO measurement, results are printed out automatically.	✓	✓	✓		✓
Printer output	OFF	Internal printer is disabled.					
	ON	Internal printer is active.				✓	
Patient No. reset	OFF	Patient No. is not reset upon power on.	✓	✓	✓		✓
	ON	Patient No. is reset upon power on.				✓	
Display of patient ID	OFF	Patient ID is not displayed.				✓	
	ON	Patient ID is displayed.	✓	✓	✓		✓
Patient ID (Mandatory)	OFF	Patient ID is not displayed.				✓	
	ON	Patient ID is displayed.					
Device ID number	1-99 Set by ten-key display.	Sets the Device ID number.			1		
Display of Device ID num.	OFF	Device ID is not required.			✓		
	ON	Device ID is required.					
Start time of sleep mode	OFF	Power save function is not used.					
	1 min	Power save status in 1min after last operation.					
	5 min	Power save status in 5min after last operation.					
	10 min	Power save status in 10min after last operation.			✓		
	20 min	Power save status in 20min after last operation.					
	30 min	Power save status in 30min after last operation.					
Number of auto-shoot	1-10 Set by ten-key display.	The number of continuous measurements			3		
	Every time	Fog timing is applied every time.					
Fog timing	Once	Fog timing is applied only once before the 1st measurement.			✓		
	Date/Time	Set by ten-key display. Sets year, month, day, time (24hrs), minute and second					Installation date/time
Sph/Cyl step	0.12	Sph/Cyl is displayed by 0.12D step.					
	0.25	Sph/Cyl is displayed by 0.25D step.			✓		
Axis step	1	Axial angle is displayed by 1° step			✓		
	5	Axial angle is displayed by 5° step					

Descriptions	Options	Details	Initial value (Region)				
			A	C	E	J	G
VD	0.00	VD value (Distance between corneal vertex and eyeglass lens rear surface) is set to 0mm (contact lens).					
	12.00	VD value (Distance between corneal vertex and eyeglass lens rear surface) is set to 12.00mm (eyeglass lens).		✓		✓	✓
	13.75	VD value (Distance between corneal vertex and eyeglass lens rear surface) is set to 13.75mm (eyeglass lens).	✓		✓		
ADD	NO	The typical additional power for the age can be selected.			✓		
	40-44						
	45-49						
	50-54						
	55-59						
	60-64						
	65-69						
	70-74						
D or mm (KRT)	D	D (diopter) of corneal refractive power					
	mm	mm of corneal curvature			✓		
HV or R1R2	HV	Corneal curvature radius measurement result on screen is displayed by HV					
	R1R2	Corneal curvature radius measurement result on screen is displayed by R1R2(flat/steep meridian).			✓		
Display KRT unit	OFF	KRT unit is not shown.			✓		
	ON	KRT unit is shown.	✓	✓		✓	✓
Cylinder sign	-	Cylinder sign is "-".			✓		
	+	Cylinder sign is "+".					
	MIX	Cylinder sign is "+" and "-".					
Measure mode setting	REF	Default measurement mode is REF.					
	REF/KRT	Default measurement mode is R/K.			✓		
	KRT	Default measurement mode is KRT.					
R/L or OD/OS	R/L	Right/left eyes is displayed by R/L.			✓		
	OD/OS	Right/left eyes is displayed by OD/OS.					
Touch panel brightness	LEVEL 1 (dark)	The brightness of touch panel.					
	LEVEL 2						
	LEVEL 3						
	LEVEL 4 (bright)				✓		
Display of REF average	OFF	REF average is not displayed.			✓		
	ON	REF average is displayed.					
Packing mode	Execute	This instrument is set to the condition for packing.				-	
Use original IPA font	OFF	A line of the frame is shown to the character of the measurement values, etc.			✓		
	ON	A line of the frame disappears in the character of the measurement values, etc.					
Eyelid fuction	OFF	The eyelid function is invalidated.					
	ON	The eyelid function is made effective.			✓		
Eyelid Force Meas. time	0-99 Set by ten-key display.	The time until measurement is forcibly begun is set after eyelid detection message is displayed.				99	
Inspection mode	OFF	Inspection mode is released.			✓		
	ON	Inspection mode is set to measure model eye.					
SCA display type	SIMPLE	When the measurement results of the spherical refractive-power (S) and cylindrical refractive power (C) are over 0, the plus sign (+) is not displayed. When the cylindrical refractive power is at OD, the values of cylindrical refractive power and the direction of cylindrical axis (A) are not displayed.			✓		
	ALL	When the measurement results of the spherical refractive-power (S) and cylindrical refractive power (C) are over 0, the plus sign (+) is displayed. When the cylindrical refractive power is at OD, the cylindrical refractive power is displayed at 0.00 and the direction of cylindrical axis (A) is displayed at 0.					
Center/Peripheral	Center	When turning on the power or moving to the next patient, start the KRT measurement with only the center.			✓		
	Peripheral	When turning on the power or moving to the next patient, start the KRT measurement with the peripheral.					
Peripheral Point	9 POINTS	Outputs of the center, peripheral curves at 8 points along horizontal, vertical, 45°, 135° directions.			✓		
	5 POINTS	Outputs of the center, peripheral curves at 4 points along the strong/weak principal meridians and E value.					

Descriptions	Options	Details	Initial value (Region)				
			A	C	E	J	G
R/K $\leftrightarrow$ Mapping change	R/K	When turning on the power or moving to the next patient, set the mapping function to OFF.	✓				
	Mapping	When turning on the power or moving to the next patient, set the mapping function to ON.					
Anterior lighting mode	RING	Light the anterior segment by blinking fast of the whole ring.	✓				
	STATIC	Light the anterior segment by turning on the ring partly. If this instrument affects the surrounding infrared communication equipment. Please set it to STATIC.					
Mapping scale	Normalized	When turning on the power or moving to the next patient, set mapping scale to the "Normalized" (NORM: Relative value scale). The center of the scale is automatically determined based on the measurement result, and it is output in accordance with the mapping step.	✓				
	Absolute	When turning on the power or moving to the next patient, set mapping scale to the "Absolute" (ABS: Absolute value scale). The scale display range is fixed at 34.5D to 67.5D, and it is output with the fixed 1.5D of the mapping display step.					
	Adjustable	When turning on the power or moving to the next patient, set mapping scale to the "Adjustable" (ADJ: Adjustable relative value scale). It is a relative value scale which can change the center value of the color code and the display step.					
Mapping step	D:0.5, mm:0.1	When turning on the power or moving to the next patient, set mapping step to the "D:0.5, mm:0.1".	✓				
	D:1.0, mm:0.2	When turning on the power or moving to the next patient, set mapping step to the "D:1.0, mm:0.2".					
	D:1.5, mm:0.3	When turning on the power or moving to the next patient, set mapping step to the "D:1.5, mm:0.3".					
ADJ. center val(D)X10	300-500 Set by ten-key display.	Set the center value when mapping scale type is "Adjustable". It can be set in 0.1 steps within the range of 30.00 D to 50.00 D. When the display unit on the mapping screen is in mm units, it is converted to mm units and reflected in the mapping display.	475				
Mapping display mode	Mapping	When turning on the power or moving to the next patient, in the mapping display, an opaque map is displayed overlaying on the anterior segment.	✓				
	Anterior	When turning on the power or moving to the next patient, display only the anterior segment in the mapping display.					
	Overlay	When turning on the power or moving to the next patient, in the map display, a transparent map is displayed overlaying on the anterior segment.					
Mapping unit	D	When turning on the power or moving to the next patient, set mapping unit to the "D".	✓				
	mm	When turning on the power or moving to the next patient, set mapping unit to the "mm".					
Mapping print reverse	OFF	The color at mapping print is not reversed in black and white.	✓				
	ON	The color at mapping print is reversed in black and white.					
BC ADVICE	OFF	When turning on the power supply and moving to the next patient, set not to display the base curve value.	✓				
	ON	When turning on the power supply and moving to the next patient, set to display the base curve value.					
BC display type	RGP	BC display type set to "7.8mm spherical les RGP (OZ): Advice the base curve value of the Spherical lens."	✓	✓		✓	✓
	ASP	BC display type set to 4.0mm aspherical lens ASP: Advice the base curve value and E value of the Aspherical lens.			✓		
Factory Data Reset	Execute	All setting is reset to the factory default settings.	-				



## SETTING OF INTERNAL PRINTER (PRINT)

Print contains settings related to output from the internal printer.

	Description	Options	Details	Initial value (Region)				
				A	C	E	J	G
Preset	-	All	Print format of preset is All. (For the details of "All," refer to "PRINTOUT FORMAT SETTING" on page 21.)	✓				
	-	Ave	Print format of preset is Ave. (For the details of "Ave," refer to "PRINTOUT FORMAT SETTING" on page 21.)					
	-	Classic	Print format of preset is Classic. (For the details of "Classic," refer to "PRINTOUT FORMAT SETTING" on page 21.)					
Common	Barcode	OFF	Barcode is not printed.	✓				
		ON	Barcode is printed.					
	Operator ID	OFF	Operator ID is not printed.	✓				
		ON	Operator ID is printed.					
	Name	OFF	"Name" space is not available.				✓	
		ON	"Name" space is available.	✓	✓	✓		✓
	Date	OFF	Date is not printed.					
		ON	Date is printed.	✓				
	Date style	YMD	Print in Year/Month/Day format.		✓		✓	✓
		MDY	Print in Month/Day/Year format.	✓				
		DMY	Print in Day/Month/Year format.			✓		
	Patient No./Patient ID	OFF	Patient No./Patient ID is not printed.				✓	
		ON	Patient No./Patient ID is printed.	✓	✓	✓		✓
	Device ID number	OFF	Device ID No. is not printed.	✓				
		ON	Device ID No. is printed.					
	Serial number	OFF	Serial No. is not printed.				✓	
		ON	Serial No. is printed.	✓	✓	✓		✓
	Include error data	OFF	"Error" data is not printed.	✓				
		ON	"Error" data is printed.					
	TOPCON logo	OFF	TOPCON logo is not printed.					
		ON	TOPCON logo is printed.	✓				
	Message print	OFF	Message is not printed.	✓				
		ON	Message is printed.					
	Input message	Set by keyboard display.	String of up to 72 characters.	NONE				
Graphic print	Normal Printer	Picture of refractive condition is not printed.	✓					
	Graphic Printer	Picture of refractive condition is printed.						
Line space	0-24 Set by ten key display.	Line space is set in dot units.	0					
Auto Cut	OFF	Auto cut is carried out.						
	ON	Auto cut is not carried out.	✓					

\* : Depending on the destination, preset values differ.

	Description	Options	Details	Initial value (Region)				
				A	C	E	J	G
REF/KRT (Print setting on R/K mode)	Print Layout	R/L	Measurement values are printed in terms of Right or Left.					
		DATA	Measurement values are printed in terms of REF or KRT.					✓
	VD	OFF	VD value (Vertex distance) is not printed.					
		ON	VD value (Vertex distance) is printed.					✓
	Cylinder sign	OFF	Cylinder sign is not printed.					
		ON	Cylinder sign is printed.					✓
	Print form of REF result	ALL	All refractive measurements are printed.					✓
		AVE	Only averaged is printed.					
	Reliability	OFF	Reliability number is not printed.					✓
		ON	Reliability number is printed.					
	S.E.	OFF	S.E. is not printed.					
		ON	S.E. is printed.					✓
	PD	OFF	PD value is not printed.					
		ON	PD values is printed.					✓
	ADD	OFF	ADD value is not printed.					✓
		ON	ADD value is printed.					
	KRT print layout	D/mm	KRT data is printed as follows, D (corneal refractive power)/mm (corneal curvature).					✓
		mm/D	KRT data is printed as follows, mm (corneal curvature)/D (corneal refractive power).					
	Print form of KRT result	ALL	All measurement values are printed.					✓
		AVE	Only average value are printed.					
	KRT ave. -HV or R1R2	HV	Kerato average in print out is HV (horizontal/vertical).					
		R1R2	Kerato average in print out is R1R2 (flat/steep meridian).					✓
	KRT data -HV or R1R2	HV	KRT measurement result is printed in HV (horizontal/vertical).					
		R1R2	KRT measurement result is printed in R1R2 (flat/steep meridian).					✓
	KRT average	OFF	KRT average value is not printed.					
		ON	KRT average value is printed.					✓
	KRT cylinder	OFF	Kerato-cylinder value and axial angle are not printed.					
		ON	Kerato-cylinder value and axial angle are printed.					✓
Corneal diameter	OFF	Corneal diameter is not printed.						
	ON	Corneal diameter is printed.					✓	
REF (Print setting on REF mode)	VD	OFF	VD value (Vertex distance) is not printed.					
		ON	VD value (Vertex distance) is printed.					✓
	Cylinder sign	OFF	Cylinder sign is not printed.					
		ON	Cylinder sign is printed.					✓
	Print form of REF result	ALL	All refractive measurements are printed.					✓
		AVE	Only typical value is printed.					
	Reliability	OFF	Reliability number is not printed.					✓
		ON	Reliability number is printed.					
	S.E.	OFF	S.E. is not printed.					
		ON	S.E. is printed.					✓
	PD	OFF	PD value is not printed.					
		ON	PD values is printed.					✓
	ADD	OFF	ADD value is not printed.					✓
		ON	ADD value is printed.					

	Description	Options	Details	Initial value (Region)				
				A	C	E	J	G
KRT (Print setting on KRT mode)	KRT print layout	D/mm	KRT data is printed as follows, D (corneal refractive power)/mm (corneal curvature).	✓				
		mm/D	KRT data is printed as follows, mm (corneal curvature)/D (corneal refractive power).					
	Print form of KRT result	ALL	Printout all measurement values.	✓				
		AVE	Printout only average value.					
	KRT ave. -HV or R1R2	HV	Display average of KRT measurement results is set to HV (horizontal/vertical).					
		R1R2	Display average of KRT measurement results is set to R1R2 (flat/steep meridian).	✓				
	KRT data -HV or R1R2	HV	KRT measurement result is printed in simple format.					
		R1R2	KRT measurement result is printed in full format.	✓				
	KRT average	OFF	Do not print KRT average value.					
		ON	Print KRT average value.	✓				
	KRT cylinder	OFF	Do not print kerato-cylinder value and axial angle.					
		ON	Print kerato-cylinder value and axial angle.	✓				
Corneal diameter	OFF	Do not print corneal diameter.						
	ON	Print corneal diameter.	✓					

## DATA COMMUNICATION (COMM)

Comm contains settings related to data output with the external device.

Description	Options	Details	Initial value (Region)				
			A	C	E	J	G
Output data format	REF	Only REF data are output.					
	KRT	Only KRT data are output.					
	ALL	All data are output.	✓				
Communication Format	OLD	OLD TOPCON format	✓				
	NEW	NEW TOPCON format					
	STD1	TOPCON STD1 format					
	STD2	TOPCON STD2 format					
	STD4	TOPCON STD4 format					
	CM1	Custom specification					
	CM4	Custom specification					
	EXT2						
	EXT3						
Use of Output port	OFF	RS-232C port is disabled.	✓				
	ON	RS-232C port is enabled.					
Baudrate setting	2400bps	Baudrate value:2400bps	✓				
	9600bps	Baudrate value:9600bps					
	19200bps	Baudrate value:19200bps					
	38400bps	Baudrate value:38400bps					
PC software setup	Execute	Correction value data related to mapping measurement of main unit is output.	-				
JPEG output	OFF	JPEG output is not performed in the output in EXT format.	✓				
	ON	JPEG output is performed in the output in EXT format.					

## LAN CONNECTION (LAN)

LAN contains settings related to data output via LAN.

Description	Options	Details	Initial value (Region)				
			A	C	E	J	G
LAN connection	OFF	LAN connection is off.	✓				
	ON	LAN connection is on.					
Shared folder Setting	Shared Folder (up to 32 characters) User Name (up to 32 characters) Password (up to 16 characters) Set by keyboard display	Path and permission to shared folder is set.	NONE				
IP address setting	FIX	Assign IP address manually.	✓				
	AUTO	Assign IP address automatically.					
IP address	0.0.0.0 Set by keyboard display	IP address of KR-800PA to output data.	0.0.0.0				
Subnet mask	0.0.0.0 Set by keyboard display	Subnet mask address of KR-800PA.	0.0.0.0				
Default gateway	0.0.0.0 Set by keyboard display	Default gateway address of KR-800PA.	0.0.0.0				
Primary DNS server	0.0.0.0 Set by keyboard display	Primary DNS Server number.	0.0.0.0				
Secondary DNS server	0.0.0.0 Set by keyboard display	Secondary DNS Server number.	0.0.0.0				

## OPERATOR ID

OPERATOR contains settings related to Operator ID.

Description	Options	Details	Initial value (Region)				
			A	C	E	J	G
Use Operator ID	OFF	Operator ID will be displayed on the touch panel and output.	✓				
	ON	Operator ID will not be displayed on the touch panel and output.					
Prefix of Ope. ID	Set by ten-key display. (up to 3 characters)	Set the Prefix of Operator ID can be registered.	NONE				
Operator ID (Mandatory)	OFF	Operator ID is not required.	✓				
	ON	Operator ID is required.					
Fixed Ope. ID setting	OFF	Operator ID is not fixed.	✓				
	ON	Operator ID is fixed.					
Fixed Ope. ID entry	Set by ten-key display. (up to 13 characters)	Input fixed operator ID	NONE				

## SPECIAL

SPECIAL is the mode for service engineer only; it can not be accessed.

# MAINTENANCE

## DAILY CHECKUPS

### USER MAINTENANCE ITEM

Item	Inspection time	Contents
Inspection	Before using	<ul style="list-style-type: none"><li>• The instrument works properly.</li><li>• The objective lens must be free of stain or flaw.</li></ul>
Cleaning	When the part is stained	<ul style="list-style-type: none"><li>• Objective lens</li><li>• Placido Ring</li><li>• External cover, touch panel, etc.</li></ul>
Replacement	As required	<ul style="list-style-type: none"><li>• Printer paper</li></ul>

### MANUFACTURER MAINTENANCE ITEMS

Item	Checking time	Contents
Cleaning each component	Within 12 months	<ul style="list-style-type: none"><li>• Cleaning outer covers</li><li>• Checking the optical system</li><li>• Cleaning POWER unit</li></ul>
Operation check	Within 12 months	<ul style="list-style-type: none"><li>• Checking the main body operation</li><li>• Checking switches</li></ul>
Accuracy check	Within 12 months	<ul style="list-style-type: none"><li>• Confirming the measurement functions (using special tools)</li></ul>

### MANTENACE AFTER USE

- After using, refer to "HOW TO CLEAN THIS INSTRUMENT" on page 69.
- For this instrument, dust may cause errors. When not in use, replace the measuring window cap and dust cover.
- When not in use, turn off the switch.

## **CHECKING THE MEASURING ACCURACY**

- The attached model eye should be measured and the accuracy checked at regular intervals.

- 1** To set up the model eye, insert the guide groove of the model eye to the chinrest tissue pin.
- 2** Set the "Inspection mode" of "Initial" to ON in SETUP screen.
- 3** Set the display step of spherical/cylindrical to 0.12D and perform measurement.

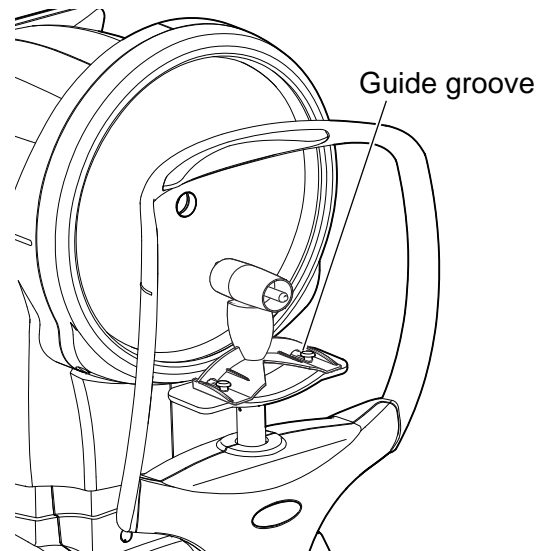

If the measurement result is widely different from the value shown on the model eye, call your dealer or TOPCON at the address on back cover.

## **BRIGHTNESS ADJUSTMENT OF TOUCH PANEL**

- The touch panel is optimally adjusted when shipped.
- For touch panel brightness adjustment, see "INITIAL (INITIAL SETTING)," "Touch panel brightness" (page 61).

## **HOW TO CLEAN THIS INSTRUMENT**

### **CLEANING THE FOREHEAD REST AND CHIN REST**

Wipe the forehead rest and the chin rest with a cloth moistened with a tepid solution of neutral detergent for kitchenware.

### **CLEANING THE PLACIDO RING AND THE COVER**

 <b>NOTE</b>	Do not clean plastic parts with solvents. Benzine, thinner, ether, gasoline and chemical duster may cause discoloring and decomposition.
---	--

- 1** If the placido ring and the cover get soiled, wipe the surface with dry cloth.
- 2** If the placido ring and the cover are noticeably stained, wipe the surface with a damp cloth which is moistened in a tepid water solution of neutral detergent.

### **CLEANING THE TOUCH PANEL**

 <b>NOTE</b>	<ul style="list-style-type: none"><li>• As the touch panel screen is a touch panel, be sure to turn off the POWER switch before wiping. The touch panel will react and malfunction.</li><li>• When the monitor cleaner has become dirty, wash it. When washing, rinse it thoroughly so no detergent is left. If the detergent is left, it may cause uneven wiping.</li></ul>
---	--

#### **CONTAMINATION BY DUST**

Remove the dust with a soft brush, and wipe with the attached monitor cleaner.

#### **CONTAMINATION BY FINGERPRINTS**

Wipe with the attached monitor cleaner.

If the stain still remains, moisten the monitor cleaner with water and then wipe off the stain.

### **CLEANING THE MEASURING WINDOW**

- Dust on measuring window ... Blow off dust with a blower.
- Fingerprints and oil spots on measuring window
  - ..... Blow off dust by a blower and wipe the surface gently with a camera lens cleaner using clean gauze.

# **REPLACING AND ORDERING CONSUMABLE ITEMS**

## **ORDERING CONSUMABLE ITEMS**

- When ordering consumable items, tell the product name, product code and quantity to your dealer or TOPCON at the address of back cover.

Product name	Product code
Chinrest tissue	40310 4082
Monitor cleaner	44800 1001
Dust cover	42360 9002

Product name	Product code
Printer paper	44800 4001

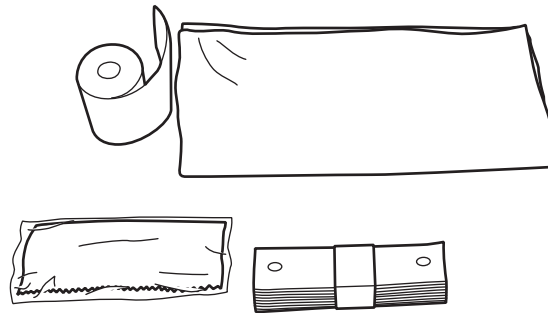

## **SUPPLYING THE CHINREST TISSUE**

- When the chinrest tissue has run out, pull off chinrest tissue pins and place new tissue.

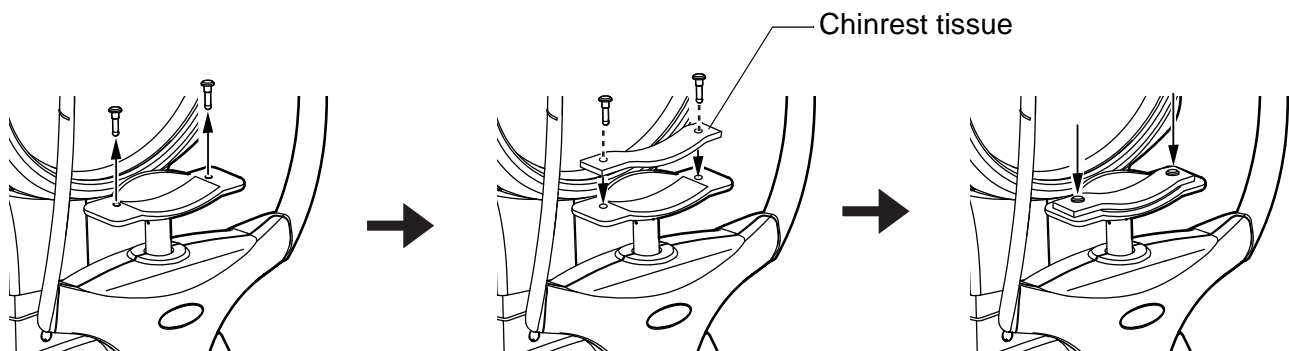
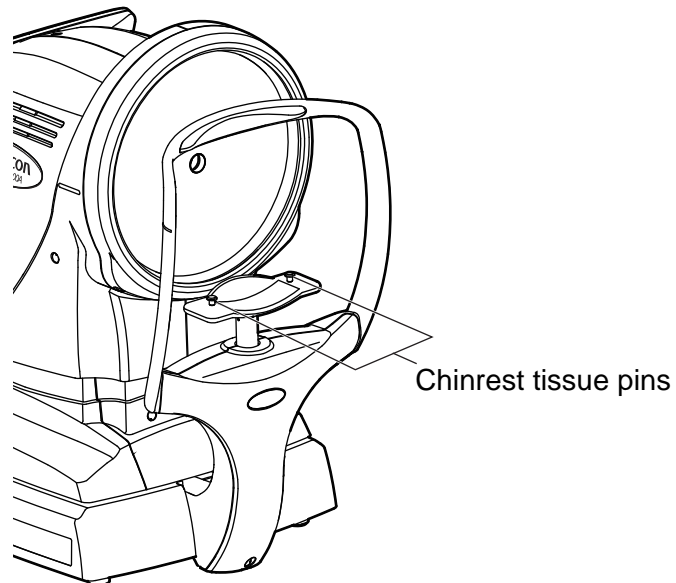



# TROUBLESHOOTING

## TROUBLE-SHOOTING OPERATIONS

### MESSAGE LIST

OVER-SPH	Spherical power exceeds +22D or -25D. Measurement cannot be performed for out of measuring range.
OVER-CYL	Cylindrical power exceeds $\pm 10D$ . Measurement cannot be performed for out of measuring range.
OVER-R	Corneal curvature exceeds 5.00-10.00mm. Measurement cannot be performed for out of measuring range.
NO TARGET	Displayed when there is no target or the eye image is too dark. You should tell the patient to open their eyes as wide as possible, and tell not to move the eyes as possible. Then perform the measurement again. Even if you cannot perform the measurement after above manner, it may be possible to measure by changing to the cataract mode(CAT).
AGAIN	Displayed when there is more than $\pm 5D$ difference from the previous measurement value. You should tell the patient to open their eyes as wide as possible, and tell not to move the eyes as possible. Then perform the measurement again.
NO CENTER	Displayed when center of eye can not be found. You should tell the patient to open their eyes as wide as possible, and tell not to move the eyes as possible. Then perform the measurement again.
ERROR	The patient's eye blinks or moves during measurement. If this message appears while with measuring model eye correctly, the instrument may have a problems. Contact your service engineer.
ALIGN ERR	Displayed when the alignment is significantly failed during the measurement. You should tell the patient to open their eyes as wide as possible, and tell not to move the eyes as possible. Then perform the measurement again.
Finished	Displayed when normal measurements are completed for the set measurement count.
Check eyelid.	Displayed when the patient's eyelid covers the pupil. Tell the patient to open their eye as wide as possible.
MOVE LEFT TO AVOID THE LIMIT.	Displayed when it reached the limit to the left in auto alignment. Move to the left by operating the control lever.
MOVE RIGHT TO AVOID THE LIMIT.	Displayed when it reached the limit to the right in auto alignment. Move to the right by operating the control lever.
LOWER CHIN REST TO AVOID THE LIMIT.	Displayed when it reached the upward limit in auto alignment. Move the chinrest to the downward.
RAISE CHIN REST TO AVOID THE LIMIT.	Displayed when it reached the downward limit in auto alignment. Move the chinrest to the upward.
MOVE FORWARD TO AVOID THE LIMIT.	Displayed when it reached forward (patient's side) limit in auto alignment. Move to the forward by operating the control lever.
MOVE BACKWARD TO AVOID THE LIMIT.	Displayed when it reached backward (operator's side) limit in auto alignment. Move to the backward by operating the control lever.
Previous measurements are left. Please press the Clear button.	Displayed when the output of all output-set data fails. Previous measurements are left. Please press the ALL CLEAR button.
No print data, please confirm measurement mode.	Displayed when the measurement mode in measuring differs from the measurement mode in printing. Set the measurement mode to the mode in measuring, and then tap the PRINT OUT button.

Patient ID is required. Please set patient ID.	Displayed when the output operation is requested when the setting "Patient ID (Mandatory)" is ON but the patient ID is not inputted. Enter the patient ID and then request the output operation.
Operator ID is required. Please set Operator ID.	Displayed when the output operation is requested when the setting "Operator ID request" is ON but the operator ID is not inputted. Enter the operator ID and then request the output operation.
Rescan ID.	Displayed when barcode reader is connected and the print out button is pushed without reading the barcode again in the readable state after reading barcode in the state to be inhibited to read. If this message is displayed, read the barcode again.
Applying network settings	Displayed when applying network setting as "LAN connection" in the "LAN" is switched to ON or OFF.
Output not set	Displayed when all output settings are OFF. Confirm that the output setting is in the correct way.
Close printer cover	The printer cover is open. Close the cover until it clicks.
Paper end	Printer paper is used up. Supply printer paper.
Fatal Error!	Displayed when the printer unit does not operate normally, such as the cutter does not work. Call the serviceman.
LAN output...	LAN data output is in process.
LAN SUCCESS	LAN data output is completed.
LAN hostname error	Failed to resolve the host name of the destination (to be connected with the shared folder). Confirm the inputted host name or DNS server address.
LAN mount Error	Failed in connection with the share folder. Confirm the address, folder name, user name and password of the destination (to be connected with the share folder).
LAN create Error	Failed in file creation. Confirm that write permission to the share folder is set correctly.
LAN write Error	Failed in writing to the file. Confirm that write permission to the share folder is set correctly. Please check if other program is accessing with the share folder.
LAN start error	Failed to reset the LAN connection. Confirm that the LAN cable connection and the LAN setting are in the correct way.
LAN stop error	Failed to reset the LAN connection. Confirm that the LAN cable connection and the LAN setting are in the correct way.
LAN restruct error	Failed to reset the LAN connection. Confirm that the LAN cable connection and the LAN setting are in the correct way.
DHCP bind error(Timeout)	Failed to communicate to DHCP server. Please contact your network administrator of the facility.
DHCP bind error(NAK)	Failed to communicate to DHCP server. Please contact your network administrator of the facility.
Failed to get IP address.	Failed in IP address auto assignment. Set a fixed IP address, or check if the DHCP server is running. Please contact your network administrator of the facility.
IP address conflicted	Displayed when the IP address is duplicated. Confirm that the IP address setting of main machine is in the correct way.
Unknown Error	Displayed in case of a LAN error other than the LAN errors mentioned previously. Call your service engineer.
RS-232C DATAOUT	RS-232C data output is in process.
RS-232C SUCCESS	RS-232C data output is completed.
RS-232C FAIL	Failed in RS-232C data transmission. Confirm that the RS-232C cable connection and the RS-232C setting are in the correct way.
Range of Input value is 1-10	Displayed when the "Cont. Cycle" is set to a value out of the specified input range. Enter a value within the input range.

First Octet is 1-223 Range	Displayed when the first octet of IP address, default gateway, primary DNS server or secondary DNS server is set to a value out of the specified input range. Enter a value within the input range.
Value is irregular. Input valid value	Displayed when the "Subnet mask" of the "LAN connection" is set to a value off the input rule. Enter a value within the "Subnet mask" input rule.
The IP address is 0-255 Range	Displayed when any one of the respective octets is set to a value out of the specified input range. Enter a value within the input range.
Prefix of exam. ID need 3 letter	Displayed when the input examiner ID prefix is less than 3 characters. Enter a prefix with 3 characters.
Not correct password	Displayed when the password inputted to select a special mode is incorrect.
Please wait until packing mode is finished...	Indicates that the packing operation is in process. Wait until it is completed.
Please check the DATE/TIME	Displayed when the battery for the built-in clock becomes run down. <ul style="list-style-type: none"> <li>- When the battery consumed, confirm the difference in time and adjust it.</li> <li>- When the battery becomes completely drained, to verify whether time stopping occurred and call your service engineer.</li> </ul>
Cannot detect x position. Please turn the switch off/on.	Displayed when the auto alignment sensor and the machine are not correctly connected or not connected at all. When this message is displayed repeatedly, even if you turn the switch on again, please call your service engineer.
Cannot detect y position. Please turn the switch off/on.	Displayed when the auto alignment sensor and the machine are not correctly connected or not connected at all. When this message is displayed repeatedly, even if you turn the switch on again, please call your service engineer.
Cannot detect z position. Please turn the switch off/on.	Displayed when the auto alignment sensor and the machine are not correctly connected or not connected at all. When this message is displayed repeatedly, even if you turn the switch on again, please call your service engineer.
Failed to initialize TF motor. Please turn the switch off/on.	Displayed when the fixation target sensor and the machine are not correctly connected or not connected at all. When this message is displayed repeatedly, even if you turn the switch on again, please call your service engineer.
Incomplete map data. Take again.	Displayed when mapping analysis is failed. Please do one of the following measures so that the Placido Ring appears on the anterior ocular, and then perform measurement again. <ul style="list-style-type: none"> <li>Open eyelids</li> <li>Focus adjustment</li> <li>Change ring light quantity</li> </ul>
LIMITED MAP DATA	Displayed when the reliability of the mapping data is low. Please do one of the following measures so that the Placido Ring appears on the anterior ocular, and then perform measurement again. <ul style="list-style-type: none"> <li>Open eyelids</li> <li>Focus adjustment</li> <li>Change ring light quantity</li> </ul>
*.**mm	Displayed when C value is an error. Please do one of the following measures so that the Placido Ring appears on the anterior ocular, and then perform measurement again. <ul style="list-style-type: none"> <li>Open eyelids</li> <li>Focus adjustment</li> <li>Change ring light quantity</li> </ul>
-0	Displayed when the BC value is negative. Indicates that the peripheral diopters are strong against the central diopter.

## TROUBLE-SHOOTING OPERATIONS



### WARNING

To avoid electrical shock, do not open the instrument.  
All service should be performed by a qualified service engineer.

If a problem is suspected, use the following check list.

If following instructions does not improve the condition, or if your problem is not included in the list, contact your dealer or TOPCON at the address on the back cover.

### CHECK LIST

Trouble	Condition	Check	Page
Touch panel does not turn on.	_____	Is power cable unplugged?	22
		Is power cable connected to the instrument?	22
Touch panel is not clear.	The image is dark.	Adjust the brightness by "Touch panel Brightness Adjust".	61
Any trouble is found in a movable part.	_____	Do not move it forcibly but call our service engineer.	37
Printing is not done.	Paper comes out without printing.	Confirm the direction of paper winding. If the direction is incorrect, reset paper to the proper direction.	24
	Paper does not come out.	If "PAPER END" displayed on touch panel, replenish printer paper.	24

## PRINTER PAPER JAM



### CAUTION

- When setting a printer paper, keep a patient's face away from the instrument. Some part of the instrument may touch the patient's lip or nose if the printer cover open button is pressed.
- To avoid failure or potential injury, do not open the printer cover while the printer is in operation.
- To avoid potential injury in case of malfunction, including a paper jam, be sure to shut off the power before attempting to repair it.
- To avoid potential injury, do not touch the printer body including metal parts or the paper cutter, while the printer is in operation or when replacing the printer paper.
- Pay much attention not to touch the internal printer's body when the cover is open. If touched, it may result in trouble due to electrostatic discharge.



### NOTE

If the printer paper is jammed in the printer, printing will stop and the jam should be cleared.

- 1** Shut off the power and open the printer cover, take out the jammed paper pieces.

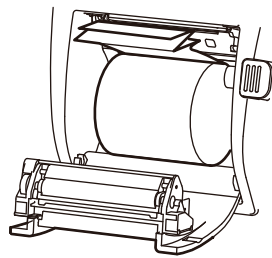

### NOTE

If the power is turned on to start after removing the jammed printer paper, a blank sheet is printed out by tapping the printer button.

# SPECIFICATIONS AND PERFORMANCE

## SPECIFICATIONS AND PERFORMANCE

Range of Refractometry Measurement	<p>Spherical refractive power: -25 to +22D (0.12D/0.25D steps)            Cylindrical refractive power: 0D to ±10D (0.12D/0.25D steps)            Direction of cylindrical axis: 1° to 180° (1°/5° steps)            (where, spherical refractive power + cylindrical refractive power ≤ +22D, or spherical refractive power + cylindrical refractive power ≤ -25D)            Measured minimum pupil diameter: φ2mm</p>
Range of Cornea Curvature Measurement	<p>Cornea curvature radius: 5.00mm to 10.00mm (0.01mm display unit)            Corneal refractive power: 67.50D to 33.75D(0.12D/0.25D steps)            (where, corneal refractive power =1.3375)            Corneal cylindrical power: 0D to ±10D (0.12D/0.25D steps)            Direction of corneal cylindrical axis: 1 to 180° (1°/5° steps)            Cornea shape measuring sites: φ1.5 mm~φ9.2 mm            (When the radius of cornea curvature is 8mm)</p>
PD measurement	20-85mm (0.5mm display unit)
External I/O terminal	USB(for Import), RS-232C(for Export), LAN(for Export)

 <b>NOTE</b>	<p>Essential performance</p> <ul style="list-style-type: none"> <li>• Measurement must be performed correctly.</li> <li>• Monitor screen display must not be distorted.</li> </ul>
---	--

# GENERAL INFORMATION ON USAGE AND MAINTENANCE

## **INTENDED PATIENT POPULATION**

The patient who undergoes an examination by this instrument must maintain concentration for a few minutes and keep to the following instructions:

- To fix the face to the chinrest, forehead rest.
- To keep the eye open.
- To understand and follow instructions when undergoing an examination.

## **INTENDED USER PROFILE**

Since the Auto Kerato-Refractometer KR-800PA are medical devices, the operation should be supervised by a physician.

## **ENVIRONMENTAL CONDITIONS OF USE**

Temperature : 10°C to 35°C  
Humidity : 30% to 90% RH(without condensation)  
Pressure : 800hPa to 1060hPa

## **STORAGE, USAGE PERIOD**

### 1. Environmental conditions (without package)

\*Temperature : 10°C to 40°C  
Humidity : 10% to 95% (without condensation)  
Pressure : 700hPa to 1060hPa

\* THIS INSTRUMENT DOES NOT MEET THE TEMPERATURE REQUIREMENTS OF ISO 15004-1 FOR STORAGE. DO NOT STORE THIS INSTRUMENT IN CONDITIONS WHERE THE TEMPERATURE MAY RISE ABOVE 40°C OR FALL BELOW 10°C.

### 2. When storing the instrument, ensure that the following conditions are met:

- (1) The instrument must not be splashed with water.
- (2) Store the instrument away from environments where pressure, temperature, humidity, ventilation, sunlight, dust, salty/sulfurous air, etc. could cause damage.
- (3) Do not store or transport the instrument on a slanted or uneven surface or in an area where it is subject to vibrations or instability.
- (4) Do not store the instrument where chemicals are stored or gas is generated.

### 3. Normal life span of the instrument:

8 years from delivery providing regular maintenance is performed [TOPCON data]

## **ENVIRONMENTAL CONDITIONS FOR PACKAGING IN STORAGE**

(Product in its normal transport and storage container as provided by manufacturer)

Temperature : -20°C to 50°C  
Humidity : 10% to 95%  
Pressure : 700hPa to 1060hPa

## **ENVIRONMENTAL CONDITIONS FOR PACKAGING IN TRANSPORTATION**

(Product in its normal transport and storage container as provided by manufacturer)

Temperature : -40°C to 70°C  
Humidity : 10% to 95%  
Pressure : 700hPa to 1060hPa

## **ELECTRIC RATING**

Source voltage : 100V- AC, 50-60Hz  
Power input : 55-90VA

## **SAFETY DESIGNATIONS PER IEC 60601-1 STANDARD**

- Type of protection against electric shocks: Class I  
The Class I equipment provides means to connect itself to the protective grounding system of utilities to thereby independently provide protection against electric shocks by keeping connectable metal components nonconductive in case of a failure in the basic insulation.
- Degree of protection against electric shocks: B type applied component  
The B type applied component provides the specified degree of protection against electric shocks with regard to the reliability particularly of leak current, patient measuring current and protective utility connection (in case of Class I equipment).
- Degree of protection against harmful intrusion of water (IEC 60529): IPX0  
This product does not provide protection against intrusion of water.  
(The degree of protection against harmful ingress of water defined in IEC 60529 is IPX0)
- Classification by sterilization/disinfection method specified by manufacturer  
This product does not have a component requiring sterilization/disinfection.
- Classification by safety of use in air/flammable anesthetic gas, oxygen or nitrous oxide/flammable anesthetic gas atmosphere
  - Equipment not suited for use in air/flammable anesthetic gas, oxygen or nitrous oxide/flammable anesthetic gas atmosphere
  - This product should be used in an environment free of flammable anesthetic gas and other flammable gases.
- Classification by operation mode  
Continuous operation refers to an operation under normal load conditions, within the specified temperature and without limitations on the operating time.
- Class of LED product: Class 1 LED product according to IEC 60825-1:2001  
Class 1 equipment is a LED product which is safe under the rationally predictable operation conditions, and keeps safety for human eyes even if any optical system (lens or telescope) is used as a condensing unit.

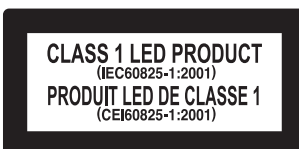

## **DIMENSIONS AND WEIGHT**

Dimensions : 321~340mm(W) × 523~539mm(D) × 490~520mm(H)  
Weight : 19.0kg



## **OPERATION PRINCIPLE**

Refraction (REF):

The instrument projects a near infra red ring of light onto the retina and the reflection of the ring is captured by a CCD camera. An internal computer analyzes the image and calculates the spherical, cylindrical and axial values.

Keratometry (KRT):

The instrument projects Placido ring onto the cornea and the reflection of the ring is captured by a CCD camera. An internal computer analyzes the image and calculates the curvature radius, corneal cylindrical axis and the corneal refractive values.

Auto alignment and auto shoot:



The alignment dot of near infrared light is projected on the cornea and the alignment dot reflection image of the cornea received by the CCD camera and the line sensor of the observation optical system is computed; and adjusted to the position suitable for measurement by the motor incorporating the main body, the measurement is started automatically.

Observation and fixation target projection:

Illuminating the test eye by near infrared light and display the image received by the CCD camera unit on the touch panel. Provide a visible light by the fixation target projection system, the patient is seen through the measurement window as a fixation target.

## **DISPOSAL**

When disposing of the instrument and/or parts, follow local regulations for disposal and recycling.

 <b>NOTE</b>		This symbol is applicable for EU member countries only. To avoid potential damage to the environment and possibly human health, this instrument should be disposed of (i) for EU member countries - in accordance with WEEE (Directive on Waste Electrical and Electronic Equipment), or (ii) for all other countries, in accordance with local disposal and recycling laws.
	This Product Contains a coin cell. You cannot replace batteries by yourself. When you need to replace and/or dispose batteries, contact your dealer or TOPCON listed on the back cover.	
		<b>EU Battery Directive</b> This symbol is applicable for EU members states only.  Battery users must not dispose of batteries as unsorted general waste, but treat properly. If a chemical symbol is printed beneath the symbol shown above, this chemical symbol means that the battery or accumulator contains a heavy metal at a certain concentration. This will be indicated as follows: Hg: mercury(0.0005%), Cd: cadmium(0.002%), Pb: lead(0.004%) These ingredients may be seriously hazardous to human and the global environment.
	This product contains a CR Lithium Battery which contains Perchlorate Material-special handling may apply. See <a href="http://www.dtsc.ca.gov/hazardouswaste/perchlorate/">http://www.dtsc.ca.gov/hazardouswaste/perchlorate/</a> Note; This is applicable to California, U.S.A. only	

## **ELECTROMAGNETIC COMPATIBILITY**

The product conforms to the EMC standard (IEC 60601-1-2 Ed3.0:2007)

- a) MEDICAL ELECTRICAL EQUIPMENT needs special precautions regarding EMC and needs to be installed and put into service according to the EMC information provided in the ACCOMPANYING DOCUMENTS.
- b) Portable and mobile RF communications equipment can affect MEDICAL ELECTRICAL EQUIPMENT.
- c) The use of ACCESSORIES, transducers and cables other than those specified, with the exception of transducers and cables sold by the manufacturer of the EQUIPMENT or SYSTEM as replacement parts for internal components, may result in increased EMISSIONS or decreased IMMUNITY of the EQUIPMENT or SYSTEM.
- d) The EQUIPMENT or SYSTEM should not be used adjacent to or stacked with other equipment. If adjacent or stacked use is necessary, the EQUIPMENT or SYSTEM should be observed to verify normal operation in the configuration in which it will be used.
- e) The use of the ACCESSORY, transducer or cable with EQUIPMENT and SYSTEMS other than those specified may result in increased EMISSION or decreased IMMUNITY of the EQUIPMENT or SYSTEM.

Item	Part Code	Model	Length(m)	
AC power cord	4480470170	–	1.5	*1
	4241220900	–	3.0	*2
Barcode scanner cable	–	–	2.5	
LAN cable (Cat.7)	–	–	3.0	
Serial cable	–	–	2.0	

\*1: Used it for AC120V

\*2: Used it for AC230V

<b>Guidance and manufacturer's declaration - electromagnetic emissions</b>		
The KR-800PA is intended for use in the electromagnetic environment specified below. The customer or the user of the KR-800PA should assure that it is used in such an environment.		
<b>Emissions test</b>	<b>Compliance</b>	<b>Electromagnetic environment - guidance</b>
RF emissions CISPR 11	Group 1	The KR-800PA uses RF energy only for its internal function. Therefore, its RF emissions are very low and are not likely to cause any interference in nearby electronic equipment.  The KR-800PA is suitable for use in all establishments other than domestic and those directly connected to the public low-voltage power supply network that supplies buildings used for domestic purposes.
RF emissions CISPR 11	Class B	
Harmonic emissions IEC61000-3-2	Class A	
Voltage fluctuations/ flicker emissions IEC61000-3-3	Complies	

**Guidance and manufacturer's declaration - electromagnetic immunity**

The KR-800PA is intended for use in the electromagnetic environment specified below.  
The customer or the user of the KR-800PA should assure that it is used in such an environment.

<b>Immunity test</b>	<b>IEC 60601 test level</b>	<b>Compliance level</b>	<b>Electromagnetic environment - guidance</b>
Electrostatic discharge(ESD) IEC 61000-4-2	± 6 kV contact  ± 8 kV air	± 6 kV contact  ± 8 kV air	Floors should be wood, concrete or ceramic tile. If floors are covered with synthetic material, the relative humidity should be at least 30%.
Electrical fast transient/burst IEC 61000-4-4	± 2 kV for power supply lines  ± 1 kV for input/output lines	± 2 kV for power supply lines  ± 1 kV for input/output lines	Mains power quality should be that of a typical commercial or hospital environment.
Surge IEC 61000-4-5	± 1 kV line(s) to line(s)  ± 2 kV line(s) to earth	± 1 kV line(s) to line(s)  ± 2 kV line(s) to earth	Mains power quality should be that of a typical commercial or hospital environment.
Voltage dips, short interruptions and Voltage variations on power supply input lines IEC 61000-4-11	<5% $U_t$ (>95% dip in $U_t$ ) for 0.5 cycle 40% $U_t$ (60% dip in $U_t$ ) for 5 cycles 70% $U_t$ (30% dip in $U_t$ ) for 25 cycles <5% $U_t$ (>95% dip in $U_t$ ) for 5 sec.	<5% $U_t$ (>95% dip in $U_t$ ) for 0.5 cycle 40% $U_t$ (60% dip in $U_t$ ) for 5 cycles 70% $U_t$ (30% dip in $U_t$ ) for 25 cycles <5% $U_t$ (>95% dip in $U_t$ ) for 5 sec.	Mains power quality should be that of a typical commercial or hospital environment. If the user or the KR-800PA requires continued operation during power mains interruptions, it is recommended that the KR-800PA be powered from an uninterruptible power supply or battery.
Power frequency (50/60 Hz) magnetic field IEC 61000-4-8	3 A/m	3 A/m	Power frequency magnetic fields should be at levels characteristic of a typical location in a typical commercial or hospital environment.

NOTE  $U_t$  is the a.c. mains voltage prior to application of the test level.

**Guidance and manufacturer's declaration - electromagnetic immunity**

The KR-800PA is intended for use in the electromagnetic environment specified below.  
The customer or the user of the KR-800PA should assure that it is used in such an environment.

Immunity test	IEC 60601 test level	Compliance level	Electromagnetic environment - guidance
<p>Conducted RF IEC 61000-4-6</p> <p>Radiated RF IEC 61000-4-3</p>	<p>3 Vrms 150kHz to 80MHz</p> <p>3 V/m 80MHz to 2.5GHz</p>	<p>3 V</p> <p>3 V/m</p>	<p>Portable and mobile RF communications equipment should be used no closer to any part of the KR-800PA, including cables, than the recommended separation distance calculated from the equation applicable to the frequency of the transmitter.</p> <p>Recommended separation distance</p> $d = 1.2 \sqrt{P}$ $d = 1.2 \sqrt{P} \quad 80\text{MHz to } 800\text{MHz}$ $d = 2.3 \sqrt{P} \quad 800\text{MHz to } 2.5\text{GHz}$ <p>where <math>P</math> is the maximum output power rating of the transmitter in watts (W) according to the transmitter manufacturer and <math>d</math> is the recommended separation distance in meters (m).</p> <p>Field strengths from fixed RF transmitters, as determined by an electromagnetic site survey,<sup>a</sup> should be less than the compliance level in each frequency range.<sup>b</sup></p> <p>Interference may occur in the vicinity of equipment marked with the following symbol:</p> 

NOTE 1 At 80 MHz and 800 MHz, the higher frequency range applies.

NOTE 2 These guidelines may not apply in all situations. Electromagnetic propagation is affected by absorption and reflection from structures, objects and people.

a Field strengths from fixed transmitters, such as base stations for radio (cellular/cordless) telephones and land mobile radios, amateur radio, AM and FM radio broadcast and TV broadcast cannot be predicted theoretically with accuracy. To assess the electromagnetic environment due to fixed RF transmitters, an electromagnetic site survey should be considered. If the measured field strength in the location in which the KR-800PA is used exceeds the applicable RF compliance level above, the KR-800PA should be observed to verify normal operation. If abnormal performance is observed, additional measures may be necessary, such as reorienting or relocating the KR-800PA.

b Over the frequency range 150 kHz to 80 MHz, field strengths should be less than 3 V/m.

**Recommended separation distance between  
portable and mobile RF communications equipment and the KR-800PA**

The KR-800PA is intended for use in an electromagnetic environment in which radiated RF disturbances are controlled. The customer or the user of the KR-800PA can help prevent electromagnetic interference by maintaining a minimum distance between portable and mobile RF communications equipment (transmitters) and the KR-800PA as recommended below, according to the maximum output power of the communications equipment.

Rated maximum output power of transmitter W	Separation distance according to frequency of transmitter m		
	150kHz to 80MHz $d = 1.2 \sqrt{P}$	80MHz to 800MHz $d = 1.2 \sqrt{P}$	800MHz to 2.5GHz $d = 2.3 \sqrt{P}$
0.01	0.12	0.12	0.23
0.1	0.38	0.38	0.73
1	1.2	1.2	2.3
10	3.8	3.8	7.3
100	12	12	23

For transmitters rated at a maximum output power not listed above, the recommended separation distance  $d$  in metres (m) can be estimated using the equation applicable to the frequency of the transmitter, where  $P$  is the maximum output power rating of the transmitter in watts (W) according to the transmitter manufacturer.

NOTE 1 At 80 MHz and 800 MHz, the separation distance for the higher frequency range applies.

NOTE 2 These guidelines may not apply in all situations. Electromagnetic propagation is affected by absorption and reflection from structures, objects and people.

## **REQUIREMENTS FOR THE EXTERNAL DEVICE**

The external device connected to the analog and digital interfaces must comply with the respective IEC or ISO standards (e.g. IEC 60950-1 for data processing equipment and IEC 60601-1 for medical equipment).

Anybody connecting additional equipment to medical electrical equipment configures a medical system and is therefore responsible that the system complies with the requirements for medical electrical systems. Attention is drawn to the fact that local laws take priority over the above mentioned requirements. If in doubt, contact your dealer or TOPCON (see the back cover).

## **PATIENT'S ENVIRONMENT**

When the patient or inspector may touch the devices (including the connecting devices) or when the patient or inspector may touch the person that comes into contact with the devices (including the connecting devices), the patient's environment is shown below.

In the patient's environment, use the device conforming to IEC60601-1. If you are compelled to use any device not conforming to IEC60601-1, use an insulation transformer.

Do not use the power strip in the patient's environment. Connect the power supply of the device to the commercial power supply.

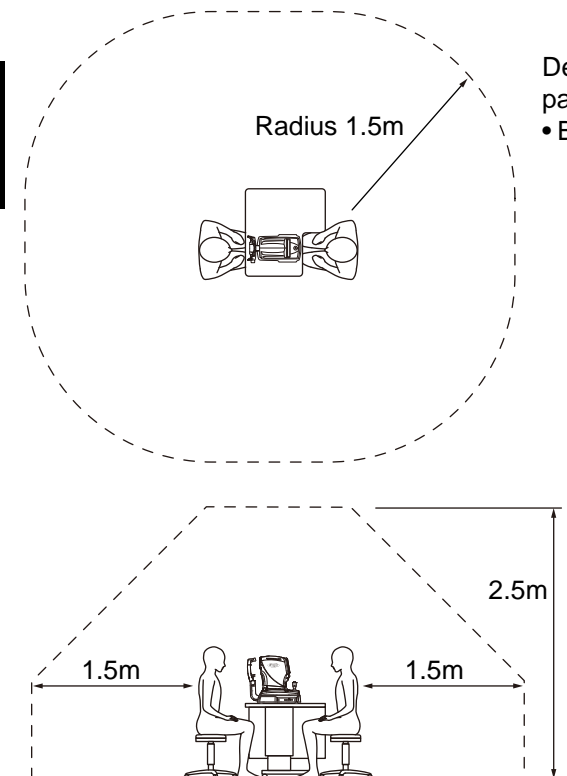

Devices applicable to the patient's environment  
• Barcode reader (Note 1)

Note 1: Use the device conforming to IEC60950-1.



### **CAUTION**

- Don't connect an additional power strip or an extension cord to the system.
- Don't connect the device which is not recognized as one component of the system.

## SAFETY OF LED PRODUCT



### CAUTION

- Use of controls or adjustments or performance of procedures other than those specified herein may result in hazardous radiation exposure.
- Do not remove the enclosures. LED high-power is radiated.

Class of LED product	CLASS1 LED PRODUCT	
LED output (Infrared)	M LED (For Measurement)	
	Aperture of LED	Objective lens *
	Output of cornea	10 $\mu$ W
	Wavelength	870nm
	Half width	50nm
	Beam divergence	(Parallel)
	Pulse width	CW - 33ms (Single)
	XY LED (For XY alignment)	
	Aperture of LED	Objective lens *
	Output of cornea	10 $\mu$ W
	Wavelength	950nm
	Half width	50nm
	Beam divergence	(Parallel)
	Pulse width	CW - 14.8 $\mu$ s (270Hz)
	PLACIDO LED (For Corneal topography)	
	Aperture of LED	Placido ring *
	Output of cornea	290 $\mu$ W
	Wavelength	940nm
	Half width	50nm
	Beam divergence	3.14 rad
Pulse width	CW - 14.8 $\mu$ s (270Hz)	
SPOT LED (For parallel projection spot)		
Aperture of LED	Parallel projection spot lens *	
Output of cornea	40 $\mu$ W	
Wavelength	940nm	
Half width	50nm	
Beam divergence	(Parallel)	
Pulse width	CW - 14.8 $\mu$ s (270Hz)	
LED output (White)	KOSHI LED (For fixation)	
	Aperture of LED	Objective lens
	15nW	15nW
	Wavelength (Centroid)	530nm
	Beam divergence	(Parallel)
	Pulse width	CW - 14.8 $\mu$ s (270Hz)

LED light source (Infrared)	M LED (For Measurement)	
	Output	70mW (CW)
	Wavelength	870nm
	Half width	50nm
	Beam divergence	0.87 rad
	XY LED (For XY alignment)	
	Output	6mW (CW)
	Wavelength	950nm
	Half width	50nm
	Beam divergence	0.14 rad
	PLACIDO LED (For Corneal topography)	
	Output	14mW (CW)
	Wavelength	940nm
	Half width	50nm
	Beam divergence	2.09rad
	SPOT LED (For parallel projection spot)	
Output	14mW (CW)	
Wavelength	940nm	
Half width	50nm	
Beam divergence	2.09rad	
LED light source (White)	KOSHI LED (For fixation)	
	Output	0.08mW (CW)
	Wavelength (Centroid)	530nm
	Beam divergence	1.05 rad

\*: LED light is emitted from the objective lens, Placido ring, Parallel projection spot lens.

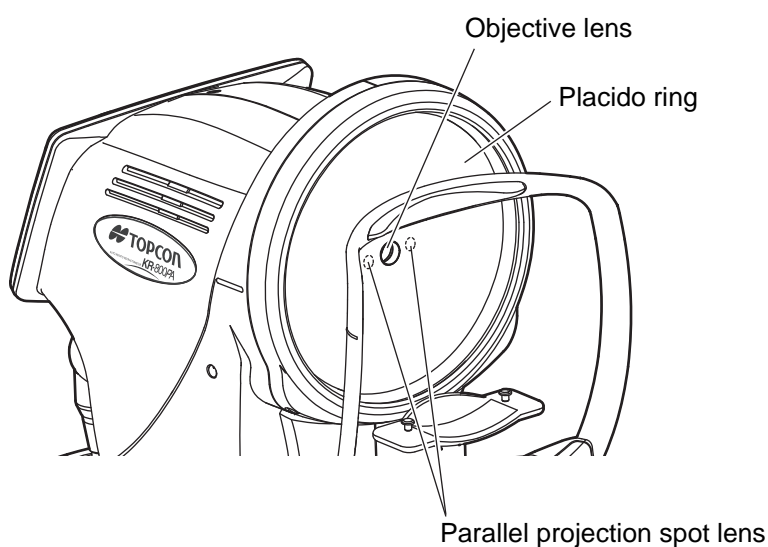



# REFERENCE

## OPTIONAL ACCESSORIES

- Adjustable instrument table AIT-16

The table height can be adjusted to facilitate measurement.

### Specifications

- Dimensions.....525(W)x490(D)mm
- Table height.....660~880mm
- Table size .....490x500mm
- Weight .....approx. 23kg
- Power consumption..... 150VA (100-120V, 220-240V)

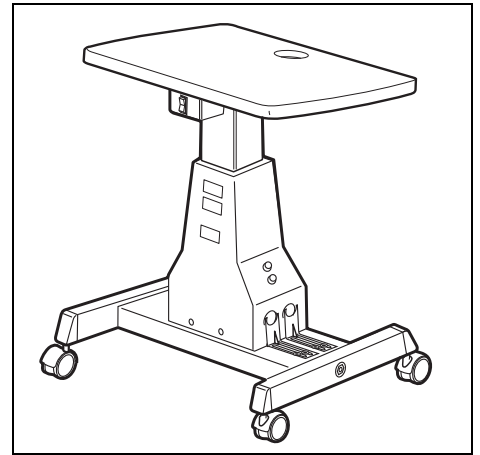

## SHAPE OF PLUG

Country	Voltage/frequency	Shape of plug
Mexico	110V/50Hz	Type C&E
Argentina	220V/60Hz	Type A
Peru	220V/60Hz	Type A
Venezuela	110V/50Hz	Type C&E
Bolivia & Paraguay	220V/60Hz	Type A (Most common) Type H (Infrequently)
Chile	220V/60Hz	Type A
Colombia	110V/50Hz	Type C
Brazil	220V/60Hz 127V/60Hz	Type A Type C
Ecuador	110V/50Hz	Type C&E
USA	120V/60Hz	Type A (Hospital Grade)
Canada	120V/60Hz	Type A (Hospital Grade)

# IPA FONT LICENSE AGREEMENT v1.0

The Licensor provides the Licensed Program (as defined in Article 1 below) under the terms of this license agreement ("Agreement"). Any use, reproduction or distribution of the Licensed Program, or any exercise of rights under this Agreement by a Recipient (as defined in Article 1 below) constitutes the Recipient's acceptance of this Agreement.

## Article 1 (Definitions)

1. "Digital Font Program" shall mean a computer program containing, or used to render or display fonts.
2. "Licensed Program" shall mean a Digital Font Program licensed by the Licensor under this Agreement.
3. "Derived Program" shall mean a Digital Font Program created as a result of a modification, addition, deletion, replacement or any other adaptation to or of a part or all of the Licensed Program, and includes a case where a Digital Font Program newly created by retrieving font information from a part or all of the Licensed Program or Embedded Fonts from a Digital Document File with or without modification of the retrieved font information.
4. "Digital Content" shall mean products provided to end users in the form of digital data, including video content, motion and/or still pictures, TV programs or other broadcasting content and products consisting of character text, pictures, photographic images, graphic symbols and/or the like.
5. "Digital Document File" shall mean a PDF file or other Digital Content created by various software programs in which a part or all of the Licensed Program becomes embedded or contained in the file for the display of the font ("Embedded Fonts"). Embedded Fonts are used only in the display of characters in the particular Digital Document File within which they are embedded, and shall be distinguished from those in any Digital Font Program, which may be used for display of characters outside that particular Digital Document File.
6. "Computer" shall include a server in this Agreement.
7. "Reproduction and Other Exploitation" shall mean reproduction, transfer, distribution, lease, public transmission, presentation, exhibition, adaptation and any other exploitation.
8. "Recipient" shall mean anyone who receives the Licensed Program under this Agreement, including one that receives the Licensed Program from a Recipient.

## Article 2 (Grant of License)

The Licensor grants to the Recipient a license to use the Licensed Program in any and all countries in accordance with each of the provisions set forth in this Agreement. However, any and all rights underlying in the Licensed Program shall be held by the Licensor. In no sense is this Agreement intended to transfer any right relating to the Licensed Program held by the Licensor except as specifically set forth herein or any right relating to any trademark, trade name, or service mark to the Recipient.

1. The Recipient may install the Licensed Program on any number of Computers and use the same in accordance with the provisions set forth in this Agreement.
2. The Recipient may use the Licensed Program, with or without modification in printed materials or in Digital Content as an expression of character texts or the like.
3. The Recipient may conduct Reproduction and Other Exploitation of the printed materials and Digital Content created in accordance with the preceding Paragraph, for commercial or non-commercial purposes and in any form of media including but not limited to broadcasting, communication and various recording media.
4. If any Recipient extracts Embedded Fonts from a Digital Document File to create a Derived Program, such Derived Program shall be subject to the terms of this agreement.
5. If any Recipient performs Reproduction or Other Exploitation of a Digital Document File in which Embedded Fonts of the Licensed Program are used only for rendering the Digital Content within such Digital Document File then such Recipient shall have no further obligations under this Agreement in relation to such actions.
6. The Recipient may reproduce the Licensed Program as is without modification and transfer such copies, publicly transmit or otherwise redistribute the Licensed Program to a third party for commercial or non-commercial purposes ("Redistribute"), in accordance with the provisions set forth in Article 3 Paragraph 2.
7. The Recipient may create, use, reproduce and/or Redistribute a Derived Program under the terms stated above for the Licensed Program: provided, that the Recipient shall follow the provisions set forth in Article 3 Paragraph 1 when Redistributing the Derived Program.

## Article 3 (Restriction)

The license granted in the preceding Article shall be subject to the following restrictions:

1. If a Derived Program is Redistributed pursuant to Paragraph 4 and 7 of the preceding Article, the following conditions must be met:
  - (1)The following must be also Redistributed together with the Derived Program, or be made available online or by means of mailing mechanisms in exchange for a cost which does not exceed the total costs of postage, storage medium and handling fees:
    - (a) a copy of the Derived Program; and
    - (b) any additional file created by the font developing program in the course of creating the Derived Program that can be used for further modification of the Derived Program, if any.
  - (2)It is required to also Redistribute means to enable recipients of the Derived Program to replace the Derived Program with the Licensed Program first released under this License (the "Original Program"). Such means may be to provide a difference file from the Original Program, or instructions setting out a method to replace the Derived Program with the Original Program.
  - (3)The Recipient must license the Derived Program under the terms and conditions of this Agreement.
  - (4)No one may use or include the name of the Licensed Program as a program name, font name or file name of the Derived Program.
  - (5) Any material to be made available online or by means of mailing a medium to satisfy the requirements of this paragraph may be provided, verbatim, by any party wishing to do so.
2. If the Recipient Redistributes the Licensed Program pursuant to Paragraph 6 of the preceding Article, the Recipient shall meet all of the following conditions:
  - (1)The Recipient may not change the name of the Licensed Program.
  - (2)The Recipient may not alter or otherwise modify the Licensed Program.
  - (3)The Recipient must attach a copy of this Agreement to the Licensed Program.
3. THIS LICENSED PROGRAM IS PROVIDED BY THE LICENSOR "AS IS" AND ANY EXPRESSED OR IMPLIED WARRANTY AS TO THE LICENSED PROGRAM OR ANY DERIVED PROGRAM, INCLUDING, BUT NOT LIMITED TO, WARRANTIES OF TITLE, NON-INFRINGEMENT, MERCHANTABILITY, OR FITNESS FOR A PARTICULAR PURPOSE, ARE DISCLAIMED. IN NO EVENT SHALL THE LICENSOR BE LIABLE FOR ANY DIRECT, INDIRECT, INCIDENTAL, SPECIAL, EXTENDED, EXEMPLARY, OR CONSEQUENTIAL DAMAGES (INCLUDING, BUT NOT LIMITED TO; PROCUREMENT OF SUBSTITUTED GOODS OR SERVICE; DAMAGES ARISING FROM SYSTEM FAILURE; LOSS OR CORRUPTION OF EXISTING DATA OR PROGRAM; LOST PROFITS), HOWEVER CAUSED AND ON ANY THEORY OF LIABILITY, WHETHER IN CONTRACT, STRICT LIABILITY OR TORT (INCLUDING NEGLIGENCE OR OTHERWISE) ARISING IN ANY WAY OUT OF THE INSTALLATION, USE, THE REPRODUCTION OR OTHER EXPLOITATION OF THE LICENSED PROGRAM OR ANY DERIVED PROGRAM OR THE EXERCISE OF ANY RIGHTS GRANTED HEREUNDER, EVEN IF ADVISED OF THE POSSIBILITY OF SUCH DAMAGES.
4. The Licensor is under no obligation to respond to any technical questions or inquiries, or provide any other user support in connection with the installation, use or the Reproduction and Other Exploitation of the Licensed Program or Derived Programs thereof.

## Article 4 (Termination of Agreement)

1. The term of this Agreement shall begin from the time of receipt of the Licensed Program by the Recipient and shall continue as long as the Recipient retains any such Licensed Program in any way.
2. Notwithstanding the provision set forth in the preceding Paragraph, in the event of the breach of any of the provisions set forth in this Agreement by the Recipient, this Agreement shall automatically terminate without any notice. In the case of such termination, the Recipient may not use or conduct Reproduction and Other Exploitation of the Licensed Program or a Derived Program: provided that such termination shall not affect any rights of any other Recipient receiving the Licensed Program or the Derived Program from such Recipient who breached this Agreement.

## Article 5 (Governing Law)

1. IPA may publish revised and/or new versions of this License. In such an event, the Recipient may select either this Agreement or any subsequent version of the Agreement in using, conducting the Reproduction and Other Exploitation of, or Redistributing the Licensed Program or a Derived Program. Other matters not specified above shall be subject to the Copyright Law of Japan and other related laws and regulations of Japan.
2. This Agreement shall be construed under the laws of Japan.

---

Please specify the following when contacting us regarding questions about this operation microscope.

- Model name: KR-800PA
  - Serial No.: Marked on the rating nameplate.
  - Period of use: Please inform us of the date of purchase.
  - Defective condition: Please provide us with as much detail as possible.
- 

AUTO KERATO-REFRACTOMETER KR-800PA

USER MANUAL

Rev.0 October 17, 2017

Published by TOPCON CORPORATION

75-1 Hasunuma-cho, Itabashi-ku, Tokyo, 174-8580 Japan.

# AUTO KERATO-REFRACTOMETER

---

## KR-800PA

---

### TOPCON MEDICAL SYSTEMS,INC.

111 Bauer Drive, Oakland, NJ 07436, USA Phone:+1-201-599-5100 Fax:+1-201-599-5250 www.topconmedical.com

### TOPCON CANADA INC.

110 Provencher Avenue, Boisbriand, QC J7G 1N1 CANADA Phone:+1-450-430-7771 Fax:+1-450-430-6457 www.topcon.ca

EC	REP
----	-----

### TOPCON EUROPE MEDICAL B.V. (EU Importer)

(European Representative)(European Sole Sales Company)  
Essebaan 11; 2908 LJ Capelle a/d IJssel; P.O.Box145; 2900 AC Capelle a/d IJssel; THE NETHERLANDS  
Phone:+31 -(0)10-4585077 FAX:+31 -(0)10-4585045 Email: medical@topcon.nl; www.topcon.eu

#### ITALY OFFICE

:Viale dell' Industria 60; 20037 Paderno Dugnano; (Milano), ITALY Phone:+39-02-9186671 Fax:+39-02-91081091 E-mail: info@topcon.it; www.topcon.it

#### DANMARK OFFICE

:Praestemarksvej 25; 4000 Roskilde, DANMARK Phone:+45-46-327500 Fax:+45-46-327555 E-mail: topcon@topcondanmark.dk www.topcondanmark.dk

#### IRELAND OFFICE

:Unit 276, Blanchardstown; Corporate Park 2 Ballycoolin Dublin 15, IRELAND Phone:+353-18975900 Fax:+353-18293915 E-mail: medical@topcon.ie; www.topcon.ie

### TOPCON DEUTSCHLAND MEDICAL G.m.b.H.

Hanns-Martin-Schleyer Strasse 41; D-47877 Willich, GERMANY Phone:+49-(0)2154+8850 Fax:+49-(0)2154-885177 E-mail: med@topcon.de; www.topcon.de

### TOPCON ESPAÑA S.A.

HEAD OFFICE:Frederic Mompou 4 Esc. A Bajos 3, 08960 Sant Just Desvern Barcelona, Spain Phone:+34-93-4734057 Fax:+34-93-4733932 E-mail: medica@topcon.es; www.topcon.es

### TOPCON S.A.R.L.

BAT A1 3 route de la révolte 93206 SAINT DENIS CEDEX, FRANCE Phone:+33 1 49 21 23 23 Fax:+33 1 49 21 23 24 E-mail:topcon@topcon.fr; www.topcon.fr

### TOPCON SCANDINAVIA A.B.

Neogatan 2; P.O.Box 25; 43151 Mölndal, SWEDEN Phone:+46-(0)31-7109200 Fax:+46-(0)31-7109249 E-mail:medical@topcon.se; www.topcon.se

### TOPCON ( GREAT BRITAIN ) LTD.

Topcon House, Kennet Side, Bone Lane, Newbury, Berkshire RG14 5PX United Kingdom  
Phone:+44-(0)1635-551120 Fax:+44-(0)1635-551170 E-mail:info@topcon.co.uk; www.topcon.co.uk

### TOPCON POLSKA Sp. z. o. o.

ul. Warszawaka 23; 42-470 Siewierz, POLAND Phone:+48-(0)32-6705045 Fax:+48-(0)32-6713405 www.topcon-polska.pl

### TOPCON SINGAPORE MEDICAL PTE. LTD.

1 Jalan Kilang Timor, Pacific Tech Centre #09-01 Singapore 159303 Phone:+65-68720606 Fax:+65-67736150 www.topcon.com.sg

#### TOPCON SINGAPORE REPRESENTATIVE OFFICE IN INDONESIA

Level 38, Tower A, Kota Kasablanka unit GH-04, Jl. Casablanca, Kav 88, Jakarta, Indonesia 12870 Phone:+62-21-2963-8004

### TOPCON INSTRUMENTS ( MALAYSIA ) SDN.BHD.

No. D1, (Ground Floor), Jalan Excella 2, Off Jalan Ampang Putra, Taman Ampang Hilir, 55100 Kuala Lumpur, MALAYSIA Phone:+60(0)3-42709866 Fax:+60-(0)3-42709766

### TOPCON INSTRUMENTS ( THAILAND ) CO.,LTD.

77/162 Sinnsathorn Tower, 37th Floor, Krungthonburi Rd., Klongtongsai, Klongsarn, Bangkok 10600, THAILAND Phone:+66(0)2-440-1152~7 Fax:+66-(0)2-440-1158

---

## Manufacturer



## TOPCON CORPORATION

75-1 Hasunuma-cho, Itabashi-ku, Tokyo, 174-8580 Japan.  
Phone:3-3558-2520 Fax:3-3960-4214 www.topcon.co.jp