

Supplement to

September 2021

Sponsored by Teleon Surgical

CRST EUROPE

Cataract & Refractive Surgery Today

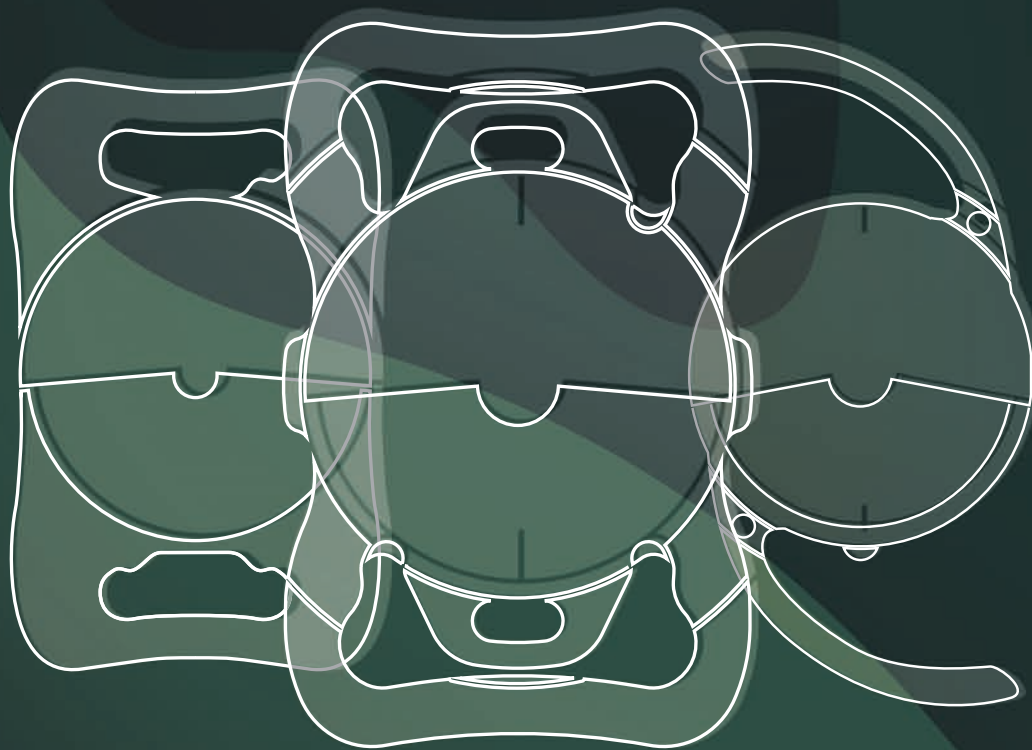

JUST EDOF IT

PASSION FOR PERFECT VISION

LENTIS® | FEMTIS® | ACUNEX®



TABLE OF CONTENTS

- 2 LENTIS Comfort and ACUNEX Vario EDOF IOLs**
The benefits of nondiffractive extended depth of focus and true comfort technology in one lens.
By Ramin Khoramnia, MD, FEBO
- 9 Customized Astigmatism Correction**
Achieving patients' expectations with the myLENTIS, LENTIS TPlusX, and LENTIS Mplus toric IOLs.
By Lourens van Zyl, MBChB, DipOphth, FCOphth, MMed(Ophth), FRANZCO, FRCSI, FEBO, MMed(RefCatSurg)
- 4 LENTIS Comfort/Comfort Toric: Results From Two Clinical PMDA Approval Trials for the Japanese Market**
With its +1.50 D near addition, this IOL provided highly satisfactory distance and intermediate vision, excellent contrast sensitivity, and low incidence of photic symptoms.
By Tetsuro Oshika, MD
- 11 The Benefits of Lens Material, Haptic Configurations, and Offering a Variety of Options**
Choosing from three distinct platforms and customizing lens power is easy with Teleon's IOLs.
By Iva Petkova, MD
- 7 Refractive Segmental Versus Diffractive Multifocal Optic Designs**
A closer look at the literature and personal results.
By Kyun-Hyung Kim, MD, PhD

LENTIS Comfort and ACUNEX Vario EDOF IOLs

The benefits of nondiffractive extended depth of focus and true comfort technology in one lens.

BY RAMIN KHORAMNIA, MD, FEBO



Extended depth of focus (EDOF) is a relatively new category of IOL that is considered by many to be an exciting frontier in lens design. EDOF IOLs are unique because they are not multifocal or trifocal and they are not accommodating,

but they provide better uncorrected intermediate visual acuity compared to a standard monofocal IOL.

According to the American National Standard for Ophthalmics ANSI Z80.35-2018, standards for an EDOF IOL apply to any IOL "whose function is the correction of aphakia, with extended range of focus above a defined functional visual acuity threshold to provide useful distance and intermediate vision with monotonically decreasing visual acuity from the best distance focal point."¹ The benefit of such lens technologies is that patients can achieve a full range of continuous, high-quality vision at various distances while avoiding the photic phenomena that are common with traditional multifocal IOLs.

DIFFRACTIVE VERSUS NONDIFFRACTIVE

Not all EDOF IOLs use the same principles to extend the depth of focus, however. The LENTIS Comfort and ACUNEX Vario (both by Teleon Surgical) are two EDOF IOLs that use a

nondiffractive, segmented EDOF principle to achieve an extended range of vision. Both lenses offer many advantages over standard monofocal IOLs, and both incorporate Continuous Transmission Technology. This design principle uses a large distance optic zone, a transition-free central optic, and an extended depth of focus segment for continuous light distribution through the entire intermediate zone. This creates what the company calls a *varifocal effect* (Figure 1). The combination of the lens' nondiffractive, segmented design and Continuous Transmission Technology help to ensure patients achieve superior visual comfort compared to a standard monofocal IOL.

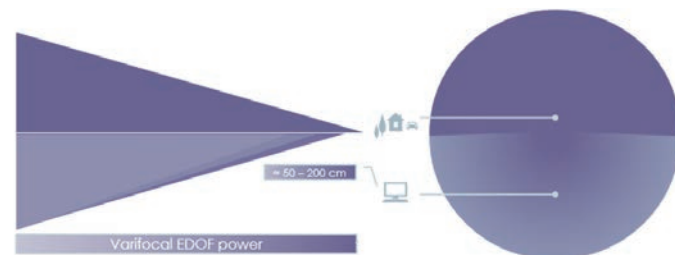

Figure 1. The LENTIS and ACUNEX IOLs are designed with a varifocal effect.

Courtesy of Teleon Surgical

LENTIS Comfort. The design of the LENTIS Comfort IOL bridges the gap between standard monofocal and multifocal and trifocal IOLs. This aberration-neutral lens extends the depth of focus for optimized vision and provides patients with excellent visual acuity in the intermediate and distance ranges. The LENTIS Comfort provides good contrast sensitivity for optimal vision in low light conditions and provides natural image and color perception.

ACUNEX Vario. The ACUNEX Vario behaves like a monofocal IOL for distance but incorporates an EDOF design and decreases the risk for dysphotopsia. The segmental optics of the ACUNEX Vario applies Continuous Transmission Technology to extend visual comfort and provide patients with a varifocal EDOF power and good intermediate visual acuity of up to 60 cm. Compared with other EDOF IOL technologies, the ACUNEX Vario provides an extended range of vision without the usual side effects of halos and glare that can be associated with diffractive IOLs (eg, multifocal and trifocal IOLs).²

Many presbyopia-correcting IOLs use a diffractive principle. The problem with diffraction, however, is that it can cause photic phenomena when creating an extended range of vision. Many patients are seeking not only good visual acuity but also good visual quality—they are not happy with unwanted photic phenomena.

The LENTIS Comfort and ACUNEX Vario IOLs, on the other hand, incorporate a segmental refractive approach to extend the range of vision. They use a lower near addition of +1.50 D to provide continuous transmission and the EDOF effect. Further, these lenses typically provide better near vision than a standard monofocal IOL.

PATIENT COUNSELING

Patients are seeing true benefits with EDOF IOLs. When I counsel patients on the LENTIS Comfort and ACUNEX Vario, for instance, I tell them that the lens helps them achieve maximum EDOF benefits with minimal risk for halos and glare. It is important that they understand the risk is not eliminated but rather it is equivalent to the risk that is associated with standard monofocal IOLs. I tell them, "Selecting this EDOF IOL doesn't mean that you will never have photic phenomena, but it means that you have the same risk as if you had selected a standard monofocal lens." This is important because, as we have seen in many trials at our research center in Heidelberg, Germany, even patients with monofocal IOLs can experience photic phenomena, although most of the time it is less frequently and less pronounced.

Patients also must be counseled that some lenses have a higher risk of photic phenomena than others. Because the LENTIS Comfort and ACUNEX Vario IOLs are similar to standard monofocal lenses in this regard, patients find them to be an interesting approach to achieving extended range of vision without the unwanted visual side effects. Patients tend to do well with these lenses and are happy with their vision after surgery. I can therefore recommend them to most patients. With trifocal lenses, on the other hand, I use a careful, conservative approach to patient selection. If I note changes on the

posterior pole and optic nerve, I would not suggest a trifocal IOL because these lenses perform best in otherwise healthy eyes. I would instead suggest a new EDOF technology such as the LENTIS Comfort and ACUNEX Vario in such cases. These lenses are well tolerated by patients, and they typically achieve spectacle independence in the intermediate and distance ranges, as well as functional vision in the near range without the loss in contrast. This certainly makes them an interesting option as a substitute for monofocal lenses.

The ideal nondiffractive EDOF candidate is a person who is interested in seeing well in the distance and intermediate ranges and doesn't mind wearing spectacles in the near distance. At the same time, the best candidates for EDOF IOLs are those who want to reduce the risk for photic phenomena.

GETTING STARTED WITH EDOF IOLS

It is my feeling that EDOF lenses are poised to replace monofocal lenses in the future. The majority of eye doctors, however, are not currently implanting presbyopia-correcting lenses at all. Many surgeons are conservative and implant monofocal lenses only because they do not want to deal with postoperative side effects and unhappy patients.

The hesitancy with using presbyopia-correcting IOLs can be avoided with nondiffractive EDOF IOLs like the LENTIS Comfort and ACUNEX Vario. These lenses are a good segue into the presbyopia-correcting IOL sector, especially for surgeons who do not want to spend extra time on careful selection of suitable patients and do not want to counsel patients extensively on photic phenomena because the risk is not any greater than it is with standard monofocal lenses. It's also important to point out that most patients are extremely pleased with their postoperative outcomes because they no longer need glasses in the intermediate distance.

CONCLUSION

For the reasons discussed here, I believe that the LENTIS Comfort and ACUNEX Vario IOLs are well poised to change the market. Both IOLs are an interesting option not only for surgeons who are already using presbyopia-correcting IOL technologies but also for cataract surgeons who have not yet gotten started with presbyopia-correcting IOLs. For those surgeons, they can continue to use a conservative approach to lens selection while providing patients with the opportunity to achieve an extended range of vision and spectacle independence without an increased risk of halos and glare or loss of contrast. ■

1. ANSI Z80.35-2018. Ophthalmics - extended depth of focus intracocular lenses. American National Standards Institute. Accessed July 19, 2021. [https://webstore.ansi.org/Standards/VIC%20\(ASC%20Z80\)/ANSIZ80352018](https://webstore.ansi.org/Standards/VIC%20(ASC%20Z80)/ANSIZ80352018)
2. Versace P. Paper presented at the: 2018 ESCRS Annual Meeting; September 22-26, 2018; Vienna, Austria.

RAMIN KHORAMNIA, MD, FEBO

- University of Heidelberg, Germany
- Ramin.Khoramnia@med.uni-heidelberg.de
- Financial disclosure: Research grants, travel fees, lecture and article fees (Teleon Surgical)



LENTIS Comfort/Comfort Toric: Results From Two Clinical PMDA Approval Trials for the Japanese Market

With its +1.50 D near addition, this IOL provided highly satisfactory distance and intermediate vision, excellent contrast sensitivity, and low incidence of photic symptoms.

BY TETSURO OSHIKA, MD



With the increasing number of presbyopia-correcting IOLs on the market today, surgeons have a variety of options to choose from when determining what type of IOL might best benefit their patients' needs. The rotationally asymmetric, refractive-segmented design of the LENTIS Comfort (Teleon Surgical) is a well-established and proven extended depth of focus (EDOF) IOL platform that is designed with a +1.50 D add to enhance intermediate vision performance while minimizing disturbing photic phenomena.¹⁻⁶ I have found that this IOL has many indications and works for a wide range of patients, largely because the design does not compromise contrast sensitivity and the lens has a similar incidence and degree of glare and halos to those of monofocal IOLs.⁶

The LENTIS Comfort IOL is designed with a zone for distance vision and a sector-shaped zone for intermediate vision. My colleagues and I conducted two prospective evaluations of our surgical results—one for the LENTIS Comfort LS-313 MF15 and one for the LENTIS Comfort LS-313 MF15T toric IOL—to assess clinical outcomes.

STUDY DESIGNS

A total of 120 eyes of 65 patients were included in the 12-month, prospective, multicenter, phase 3 clinical trial of the LENTIS Comfort LS-313 MF15 IOL, and a total of 59 eyes of 41 patients were included in the multicenter, 6-month prospective, phase 3 clinical trial of the LENTIS Comfort LS-313 MF15T toric IOL. In both studies, patients underwent standard preoperative examinations that included uncorrected (UDVA) and corrected (CDVA) distance visual acuity, uncorrected (UIVA) and distance-corrected (DCIVA) intermediate visual acuity at 70 cm, and uncorrected (UNVA) and distance-corrected (DCNVA) near visual acuity at 30 cm. Follow-up examinations were conducted at 1 day, 1 week and 1, 3, 6, 9, and 12 months after surgery in the nontoric IOL study and at 1 day, 1 week, and 1, 3, and 6 months after surgery in the toric IOL study. At each postoperative visit, the same parameters were measured as in the preoperative visit. Additionally, a defocus curve was drawn, and the degree of disturbing photic phenomena was determined based on subjective data from a patient questionnaire.

Eyes with a previous history of ocular surgery and concomitant ocular pathologies were excluded from the studies. In all cases,

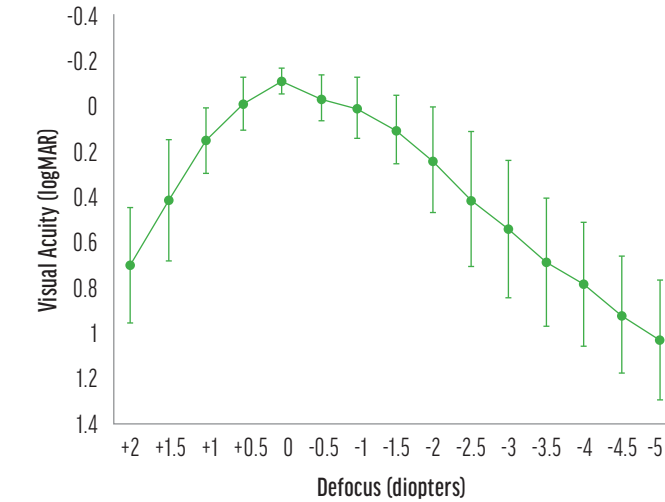

Figure 3. Defocus curve between a spectrum of +2.00 and -5.00 D.

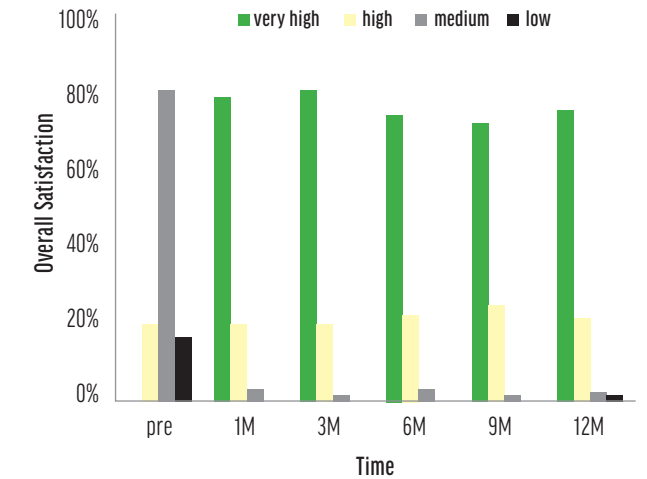

Figure 4. Patients' subjective satisfaction. Abbreviation: pre, preoperative; M, month

the refractive target was emmetropia. All surgeons in both studies used a standard phacoemulsification technique and self-sealing 2.3- or 2.4-mm incisions.

LENTIS COMFORT LS-313 MF15 STUDY RESULTS

Postoperative visual acuity. At 12 months postoperative, the results for distance visual acuity with the LENTIS Comfort LS-313 MF15 were excellent. The average UDVA was 20/20, the average CDVA was 20/16 (Figure 1), and the average UIVA and DCIVA were both 20/25 (Figure 2). UNVA remained around 20/60 and DCNVA around 20/70.

Defocus curve. When we plotted the defocus curve at 12 months postoperatively (Figure 3), we determined that 20/25 UCVA was reached at as close as 67 cm (-1.50 D) and that 20/40 was attained at as close as 45 cm (-2.20 D). The defocus curve that we obtained in this study helps to depict the design concept of the LENTIS Comfort IOL.

Contrast sensitivity. The contrast sensitivity was within a normal range for the patients' age.

Overall patient satisfaction. According to the results of a subjective patient questionnaire, the level of satisfaction with the LENTIS Comfort LS-313 MF15 remained high throughout the study period (Figure 4). There was no fluctuation over time in the severity and incidence of photic phenomena, and disturbing symptoms were infrequent (Figure 5). Mild photic phenomena were reported only by a small number of patients.

LENTIS COMFORT LS-313 MF15T STUDY RESULTS

Rotational stability. From day 1 to 6 months postoperative, the average absolute rotation of the LENTIS Comfort LS-313 MF15T toric IOL was $1.66 \pm 1.17^\circ$. In all but five eyes that could not be analyzed due to poor image quality of the photographs, the IOL did not rotate more than 10° , and in 98.1% it did not rotate more than 5° . The IOL was repositioned in one eye at 22 days postoperatively for a misalignment of 19° . After the repositioning surgery, the rotation was corrected to 3.6° . Therefore, we concluded that the LENTIS Comfort LS-313 MF15T had excellent rotational stability.

Figures adapted from: Ishida T, Ara H, Fujita Y, Inamura M, Inoue Y, Noda T, Minata K. One-year clinical evaluation of rotationally asymmetric multifocal intraocular lens with +1.50-diopter near addition. *Sci Rep*. 2019;9:17177.

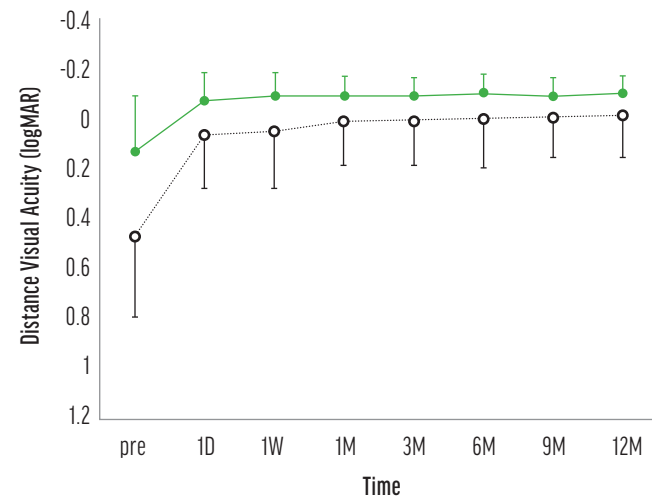

Figure 1. Uncorrected (dotted black line) and corrected (solid green line) distance visual acuities. Abbreviations: pre, preoperative; D, day; W, week; M, month

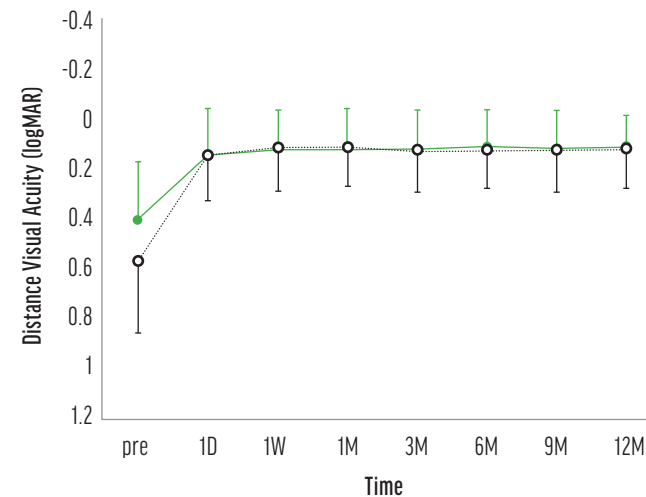

Figure 2. Uncorrected (dotted black line) and distance-corrected (solid green line) intermediate visual acuities. Abbreviations: pre, preoperative; D, day; W, week; M, month

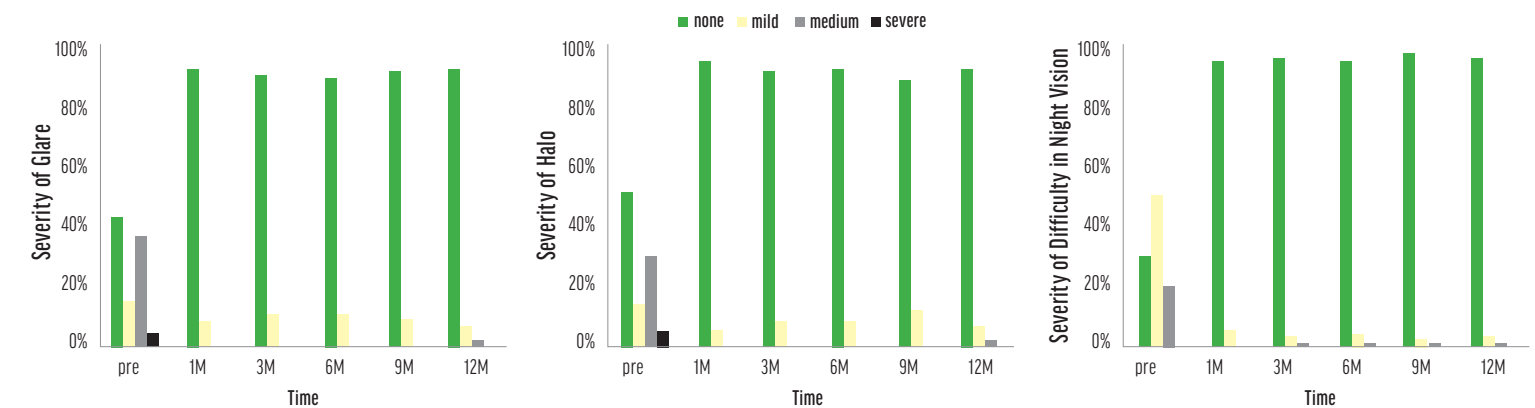

Figure 5. Incidence and severity of glare (left). Incidence and severity of halos (center). Incidence and severity of difficulty in night vision (right). Abbreviation: pre, preoperative; M, month



Postoperative visual acuity. At the 6-month follow-up visit, the average UDVA was 20/20, the average CDVA was 20/16, the average UIVA was 20/25, and the average DCIVA was 20/25.

Astigmatism. Preoperatively, the mean corneal astigmatism was 1.66 ±0.77 D. Postoperatively, corneal astigmatism was significantly reduced to manifest refractive astigmatism of between 0.32 and 0.40 D.

Defocus curve. When we plotted the defocus curve, we determined that 20/25 UCVA was reached at as close as 60 cm (-1.70 D) and that 20/40 was reached at as close as 40 cm (-2.60 D).

Contrast sensitivity. In this study, the contrast sensitivity was within a normal range for the patients' age.

Overall patient satisfaction. Of the patients in this study, most reported their overall satisfaction as very high or high. Further, the incidence of subjective photic phenomena as reported by patient questionnaire was low. No patient complained of severe photic symptoms.

CONCLUSION

In these two studies, the LENTIS Comfort IOL platform, with its rotationally asymmetric, plate-haptic, refractive-segmented multifocal design with a near addition of +1.50 D, provided patients with excellent distance visual acuity, a high level

of intermediate visual acuity, and a low incidence of photic phenomena. Further, these results showed that the plate-haptic design of the LENTIS Comfort IOL is highly effective. Both IOLs subsequently received the approval of the Japanese authorities and have been successfully commercialized in Japan since 2019. ■

1. Yoo A, Kwag JY, Song IS, et al. Comparison of visual function after implantation of inferior sector-shaped intraocular lenses: low-add +1.5 D vs +3.0 D. *Eur J Ophthalmol.* 2016;26:607-611.
2. Kretz FT, Khoramnia R, Attia MS, Koss MJ, Linz K, Auffarth GU. Clinical evaluation of functional vision of +1.5 diopters near addition, aspheric rotational asymmetric multifocal intraocular lens. *Korean J Ophthalmol.* 2016;30:382-389.
3. Vounotrypidis E, Diener R, Wertheimer C, Kreuzer T, Wolf A, Priglinger S, Mayer WJ. Bifocal nondiffractive intraocular lens for enhanced depth of focus in correcting presbyopia: clinical evaluation. *J Cataract Refract Surg.* 2017;43:627-632.
4. Pedrotti E, Mastropasqua R, Bonetto J, et al. Quality of vision, patient satisfaction and long-term visual function after bilateral implantation of a low addition multifocal intraocular lens. *Int Ophthalmol.* 2018;38:1709-1716.
5. Kim KH, Kim WS. Visual outcome and patient satisfaction of low-power added multifocal intraocular lens. *Eye Contact Lens.* 2018;44:60-67.
6. Oshika T, Arai H, Fujita Y, Inamura M, Inoue Y, Noda T, Miyata K. One-year clinical evaluation of rotationally asymmetric multifocal intraocular lens with +1.5 diopters near addition. *Sci Rep.* 2019;9:13117.

TETSURO OSHIKA, MD

■ Department of Ophthalmology, Faculty of Medicine, University of Tsukuba, Ibaraki, Japan
■ oshika@eye.ac

■ Financial disclosure: Financial support/Research funding (Alcon, Hoya, Johnson & Johnson Vision, Kowa, Novartis, Otsuka, Pfizer, Santen Pharmaceutical, Senju, Tomey, Topcon); Consultant (Alcon, Hoya, Johnson & Johnson Vision, Mitsubishi Tanabe, Santen Pharmaceutical, Topcon); Lecture honorarium (Alcon, Glaukos Japan, Hoya, Japan Focus, Johnson & Johnson Vision, Kowa, Otsuka, Santen, Senju, Tomey)

Refractive Segmental Versus Diffractive Multifocal Optic Designs

A closer look at the literature and personal results.

BY KYUN-HYUNG KIM, MD, PHD



With an increasing number of available premium IOL options, it is important for surgeons to understand the nuances of IOL design and to make an informed recommendation for patients so that they may achieve their expected outcomes. One way to achieve these goals is with multifocal IOLs.

DIFFRACTIVE VERSUS REFRACTIVE VERSUS TRIFOCAL IOLS

Multifocality is achieved through a refractive or a diffractive optical approach. With diffractive multifocal IOLs, which incorporate concentric annular rings, diffraction is intentionally induced into the optical system so that the light waves exiting the lens interfere constructively at two or more foci at different distances. With refractive multifocal IOLs, which incorporate a zonal design, the light waves exit the lens from different annular regions and are shaped so that they converge also to two or more foci. Lastly, trifocal IOLs are available that use diffractive optical approaches.

Multifocal IOLs with a rotationally asymmetric design, such as the LENTIS IOL family (Teleon Surgical), incorporate two segments, an aspheric distance vision zone and a +1.50 D sector-shaped near vision zone, that are blended to create an extended depth of focus (EDOF). This IOL design provides a smooth transition from distance to near, and the reduced add power increases intermediate visual acuity and decreases optical phenomena such as glare and halos.

The most forgiving type of IOL is a monofocal lens. After successful cataract surgery, these IOLs provide a high degree of tolerance, and patient selection is therefore very straightforward. Refractive multifocal IOLs, especially those with a refractive segmental design, also provide a high degree of forgiveness compared to diffractive multifocal IOLs. Patient counseling is also relatively straightforward with the LENTIS Comfort IOL because, in my experience, it is the next most forgiving IOL available today.

PERSONAL EXPERIENCE

I have implanted the LENTIS Comfort in about 500 patients to date. Preoperatively, I counsel patients that their intermediate and distance vision will be exceptional—in my experience J1 or J2 intermediate—and that they may need spectacle correction for near visual tasks.

I believe that the IOL provides the best results among the available low-add EDOF IOLs. Patients are extremely pleased with their postoperative results, and I have not had to explant a single

lens. Further, patients do not complain of visual disturbances including halos and glare.

I also have experience with the AcrySof IQ Vivity (Alcon), another refractive multifocal IOL design, and the Tecnis Symfony (Johnson & Johnson Vision), a diffractive multifocal IOL. To date, I have implanted about 20 Vivity IOLs and 100 Symfony IOLs. In my early experience, the Vivity provided good visual acuity. Patients, however, were more likely to complain of halos and glare postoperatively compared to patients who received the LENTIS Comfort. Likewise, in my experience with the Symfony, patient tolerance was not as strong as it is with the LENTIS Comfort.

Contrast sensitivity, in my experience, is also the highest with the LENTIS Comfort IOL compared to these other IOLs. Patients in my practice who have received a diffractive IOL sometimes complain that their visual quality in dim light is poor. With the LENTIS Comfort, however, contrast sensitivity in low-light conditions, both indoors and at nighttime, is good. This is advantageous for many patients, including the elderly and those with high myopia, mild glaucoma, macular pathologies, and a history of refractive surgery.

For all these reasons, I use the LENTIS Comfort in a wide range of patients. Simply stated, it has high forgiveness and excellent postoperative visual acuity. I usually recommend the Comfort IOL to patients who enjoy driving, including those who drive at night, and those who value their intermediate vision over near vision.

I like to underpromise and overdeliver. Therefore, I counsel patients that they may need reading glasses. Only about 50% of my Comfort patients, however, will need reading glasses at some point.

COMPARABLE RESULTS

My personal results compare favorably to a recent study that compared the visual outcomes and optical quality with two presbyopia-correcting IOLs and one monofocal IOL. In this single-center, prospective, nonrandomized, participant- and examiner-blinded cohort study, Song and colleagues compared the distance, intermediate, and near visual acuities; defocus curve; contrast sensitivity; wavefront aberrations; and modulation transfer function (MTF) with the EDOF Tecnis Symfony ZXR00, the zonal refractive multifocal LENTIS Comfort LS-313 MF15, and the monofocal LENTIS Comfort L-313 IOLs.¹ Postoperative examinations were performed at 1 week, 1 month, and 3 months. Patients also completed two questionnaires, the Visual Function Index (VF-14) and the Quality of Vision (QoV), and a self-evaluation of their visual quality.



Figures and table adapted from: Song X, Liu X, Wang W, et al. Visual outcome and optical quality after implantation of zonal refractive multifocal and extended-range-of-vision IOLs: a prospective comparison. *J Cataract Refract Surg.* 2020;46:540-546.

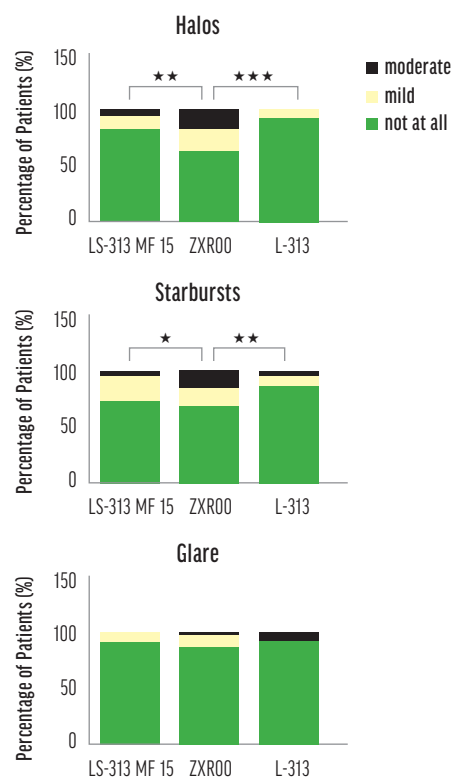

Figure 1. Severity of halo (top), starbursts (center), and glare (bottom). *P < .05; **P < .01; ***P < .001.

A total of 113 patients (age range, 50–85 years) who underwent cataract surgery were enrolled in the study. The range of intermediate vergence ($P < .05$) and distance-corrected intermediate visual acuity ($P \leq .001$) were significantly better with the LENTIS Comfort LS-313 MF15 and the Tecnis Symphony IOLs compared with the monofocal LENTIS Comfort. The two presbyopia-correcting IOLs also provided higher VF-14 ($P < .05$) and visual quality self-evaluation ($P < .05$) scores. There was no difference in score between these two IOLs, however (Table).

The total wavefront aberrations were lowest and the MTF the highest with the EDOF IOLs, but the QoV score was the lowest, especially for the severity of halos ($P < .01$) and starbursts ($P < .05$) (Figure 1). The investigators concluded that, in their study, both the Symphony and LENTIS Comfort LS-313 MF15 provided excellent and stable distance and intermediate visual acuity, good subjective visual function,

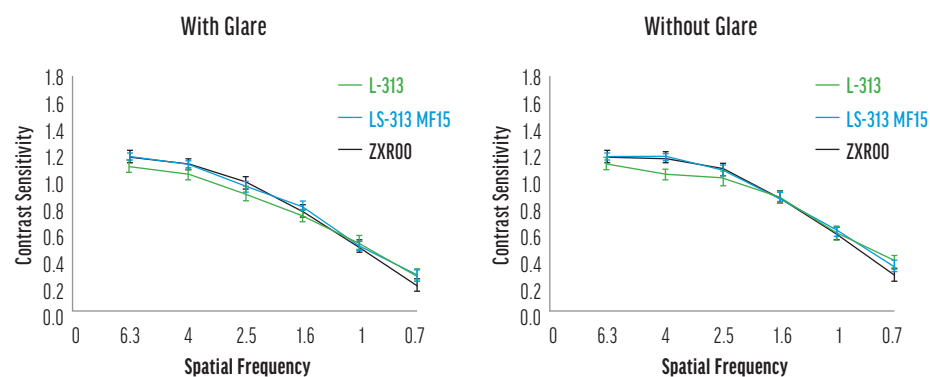

Figure 2. Contrast sensitivities with (left) and without (right) glare under mesopic conditions 3 months after IOL implantation.

TABLE. SUBJECTIVE EVALUATION BY QUESTIONNAIRES 3 MONTHS AFTER IOL IMPLANTATION					
Parameter	L-313	LS-313 MF15	ZXROO	Comparison	P Value
VF-14 score > 90 (%)	48.9	78.7	61.7	LS vs L-313 ZXROO vs L-313 LS vs ZXROO	.012* .005* .3 .114
Visual quality self-evaluation (mean ± SD) Day score	8.68 ± 1.03	8.98 ± 1.26	9.19 ± 1.25	LS vs L-313 ZXROO vs L-313 LS vs ZXROO	.029* .220 .028* 1
Night score	8.36 ± 1.16	8.90 ± 1.37	8.66 ± 1.43	LS vs L-313 ZXROO vs L-313 LS vs ZXROO	.027* .023* .318 .877
QoV score (mean ± SD)	1.83 ± 3.03	3.98 ± 6.99	5.66 ± 6.06	LS vs L-313 ZXROO vs L-313 LS vs ZXROO	0 .81 .01* .034*

Abbreviations: IOL, intraocular lens; QoV, quality of vision; VF-14, Visual Function Index questionnaire; SD, standard deviation
*P < .05, **P < .01, ***P < .001.

and good contrast sensitivity (Figure 2). Dysphotopsias were most prominent with the Tecnis Symphony EDOF IOL.

CONCLUSION

In today's competitive premium IOL market, the LENTIS Comfort is one of the most versatile and forgiving lens designs. In my experience, patients are happy with their vision, and there is a low rate of visual disturbances including halos and glare. Compared to IOLs with a

diffractive design, as well as to others with a refractive design, the LENTIS Comfort is more forgiving. This bolsters a high rate of satisfaction for a wide range of patients. ■

1. Song X, Liu X, Wang W, et al. Visual outcome and optical quality after implantation of zonal refractive multifocal and extended-range-of-vision IOLs: a prospective comparison. *J Cataract Refract Surg.* 2020;46:540-546.

KYUN-HYUNG KIM, MD, PHD
 ■ Chairman, Central Seoul Medical Center, South Korea
 ■ tigerme@naver.com
 ■ Financial disclosure: None

Customized Astigmatism Correction

Achieving patients' expectations with the myLENTIS, LENTIS TPlusX, and LENTIS Mplus toric IOLs.

BY LOURENS VAN ZYL, MBCHB, DIPOPHTH, FCOPHTH, MMED(OPHTH), FRANZCO, FRCSI, FEBO, MMED(REFCATSURG)



Spectacle independence has become one of the most important goals in modern lens extraction surgery.^{1,2} The increasing sophistication in IOL power calculations (for both spherical and astigmatic error) and in IOL designs are challenging refractive surgeons to look beyond simply restoring visual acuity. Visual acuity restoration and refractive outcomes are equally important and obtainable goals today, mainly due to our ability to plan and achieve refractive targets routinely.³ Another logical goal for many refractive surgeons and general ophthalmologists, however, is spectacle independence. Full spectacle independence has become more achievable with the advent of extended depth of focus (EDOF) and multifocal IOLs. Toric models of these lenses allow us to provide patients with astigmatism correction, further enhancing the opportunity for them to achieve spectacle independence.

AN EYE ON PATIENT SATISFACTION

As an avid golfer who also played junior amateur golf, I know that top golfers do not play with golf clubs bought from retail or sports shops. The most serious golfers all ply their trade with customized clubs fitted exactly to their individual swing and game. I have been fitted professionally with customized golf clubs, and each component of the club was specifically designed for my game. I even helped build these clubs. I believe in the same goal of customization in cataract and refractive surgery.

Working in Australia, I have several presbyopia-correcting IOLs at my disposal. Additionally, the country's Public Health Service, Medicare, and health insurance programs cover the use of toric IOLs. As a result, patients can realistically expect exceptional refractive outcomes without incurring any out-of-pocket expenses. I use an array of presbyopia-correcting lenses, including trifocal, multifocal, and EDOF IOLs. Each patient goes through vigorous informed consent and consultation, and several options are presented to them and discussed in detail. The decision is then up to the patient to choose their IOL. In my practice, approximately 30% of patients opt for a diffractive trifocal IOL; the rest opt for refractive IOL options. This is mostly due to less nighttime photopic phenomena and better contrast sensitivity with the latter group of lenses.

ASTIGMATISM CORRECTION

The closer you can get a patient to a zero refraction, the better the unaided visual outcome will be. Even when a tiny amount of

cylinder is left in the eye, it affects visual quality. When patients have at least 0.50 D of corneal astigmatism and have chosen a refractive multifocal IOL, I prefer the LENTIS family of IOLs (Teleon Surgical), which include the myLENTIS, LENTIS TPlusX, and LENTIS Mplus toric. The IOLs come in three add powers with narrow diopter steps and can be customizable in units of 0.01 D steps for sphere and cylinder. Most other retail lenses only have astigmatic corrections in units of 0.50 or 0.75 D. When I discuss lens options with my patients who have astigmatism, I ask them, "Would you want a lens that comes in 0.75 D steps or 0.01 D steps?" The answer is quite clear.

In my experience, the best way to give patients a spectacle-free outcome after refractive cataract surgery is to customize the lens. With the LENTIS toric IOLs, this can even be done for patients with very high amounts of astigmatism, such as those with previous corneal transplants and corneal lacerations. When we can get these patients to be 20/20 without glasses and treat almost all of their astigmatism, they are ecstatic.



Figure 1. Example of a customized IOL printout.



CLINICAL EXPERIENCE

I currently use the Barrett Online Toric IOL formula in conjunction with lens customization, and this has produced exceptional results. In fact, I've never had to enhance any patient who has received a customized LENTIS toric lens.

Study design. We recently evaluated the accuracy of astigmatic refractive outcomes in patients who received a customized LENTIS toric IOL. In this study, the Barrett Online Toric Calculator was used to calculate both the spherical and cylindrical component of an IOL. This calculation incorporates the effect of the posterior corneal surface on the final cylindrical outcome. The data was then used with the Teleon online calculator to calculate and customize the spherical and cylindrical components of the IOL to a tolerance of 0.01 D (Figures 1 and 2).

In this series, 90 eyes (48 patients) received a LENTIS toric IOL. Only eyes with the potential for a satisfactory outcome were included in the study, and no eyes had signs of retinal and corneal comorbidities. Astigmatic correction ranged from 0.27 to 4.98 D, and the mean preoperative keratometric astigmatism was 1.32 D. Routine phacoemulsification was performed using a 2.2-mm temporal clear corneal incision with a calculated surgically induced astigmatism of 0.00 D. The toric IOL was implanted in the capsular bag and rotated to 90° because the toric component is customized to the desired axis with the IOL in a vertical axis of 90°. All surgeries were uncomplicated, and all toric components of the IOLs were within 5° of the desired axis.

At 6 weeks postoperative, subjective refraction was performed to compare the target and achieved outcomes in order to calculate the absolute prediction error.

Results. Postoperatively, there was no significant IOL rotation. The mean postoperative refractive astigmatism was 0.31 D. All eyes had a postoperative uncorrected distance visual acuity of

0.0 logMAR (20/20) and postoperative refractive outcomes within ±1.00 D of the predicted cylindrical outcome. Further, 94% were within ±0.50 D, and 40 of the 90 operated eyes had a postoperative refraction of plano. The mean absolute prediction error was 0.32 D.

Customizing astigmatism correction with the LENTIS toric IOL in conjunction with the use of the Barrett Online Calculator produced accurate visual and refractive outcomes. In our experience, these outcomes were clinically more accurate than outcomes with other toric lenses. In the current study, 44% of eyes had no measurable refractive error on manifest refraction postoperatively. Of those that had a measurable refractive error with manifest refraction, most were no more than 0.50 D. Further, most patients with residual refractive errors were those with oblique corneal astigmatism and corneal astigmatism of greater than 2.50 D.⁴⁻⁷

The Barrett formula adjusts for posterior corneal astigmatism at oblique angles and corneal astigmatism of more than 2.50 D. Adjustments are not needed in patients with anterior oblique corneal astigmatism and corneal astigmatism of more than 2.50 D. It is postulated that this is the main reason why these patients had residual refractive errors.⁴ Even when the residual postoperative refraction was low, however, patients had very good visual outcomes despite their corneal astigmatism.

A larger study is warranted to show any statistical significance. There was, however, an observable clinical significance of better refractive outcomes with the customized LENTIS toric IOL compared with other toric lens models.

CONCLUSION

Residual refractive astigmatism is regarded as one of the main causes of patient dissatisfaction following lens extraction surgery.² The achievement of consistent and accurate refractive outcomes is possible with the combined use of a customized toric IOL (LENTIS) in conjunction with the use of the Barrett Online Calculator. In our evaluations, this lens is a safe and accurate method of obtaining favorable postoperative refractive and visual outcomes. ■

1. Mojis P, Peña-García P, Liehneova I, Zlak P, Alió JL. Outcomes of a new diffractive trifocal intraocular lens. *J Cataract Refract Surg*. 2014;40(1):60-69.
2. Law EM, Aggarwal RK, Kasaby H. Clinical outcomes with a new trifocal intraocular lens. *Eur J Ophthalmol*. 2014;24(4):501-508.
3. Alpins NA. A new method of analyzing vectors for changes in astigmatism. *J Cataract Refract Surg*. 1993;19:524-533.
4. Goggin M, Zamora-Alejo K, Esterman A, van Zyl L. Adjustment of anterior corneal astigmatism values to incorporate the likely effect of posterior corneal curvature for toric intraocular lens calculation. *J Refract Surg*. 2015;31:98-102.
5. Goggin M, van Zyl L, Caputo S, Esterman A. Outcome of adjustment for posterior corneal curvature in toric intraocular lens calculation and selection. *J Cataract Refract Surg*. 2016;42:1441-1448.
6. Sheen-Ophir S, LaHood B, Goggin M. Refractive outcome of toric intraocular lens calculation in cases of oblique anterior corneal astigmatism. *J Cataract Refract Surg*. 2020;46:688-693.
7. LaHood BR, Goggin M, Esterman A. Assessing the likely effect of posterior corneal curvature on toric IOL calculation for IOLs of 2.50 D or greater cylinder power. *J Refract Surg*. 2017;33:730-734.

LOURENS VAN ZYL, MBCHB, DIPOPHTH, FCOPTH, MMED(OPHTH), FRANZCO, FRCSI, FEBO, MMED(REFCATSURG)

- Crystal Eye & Laser Centre, Booragoon and Craigie, Australia
- lourens.vanzyl@crystaleye.com.au; Instagram and Twitter @drvanzyleyes
- Financial disclosure: None

The Benefits of Lens Material, Haptic Configurations, and Offering a Variety of Options

Choosing from three distinct platforms and customizing lens power is easy with Teleon's IOLs.

BY IVA PETKOVA, MD



Patient expectations are at an all-time high, and helping our patients achieve the best, most accurate refractive outcomes after cataract surgery goes far beyond performing advanced diagnostics and other preoperative testing to assist with IOL selection. Other considerations including the patient's history, lifestyle, and visual preferences as well as the ability to truly customize the procedure to a patient's needs are equally important in the final decision. Success begins in the examination room, but it ends with the surgeon's expertise and knowledge. Having access to IOLs with varying lens materials, haptic configurations, and optic designs is beneficial to serve a larger patient population.

SELECTING A PLATFORM

Today, a growing number of presbyopia-correcting IOLs are available worldwide, and it is no longer appropriate to select a model and power of a standard monofocal IOL for each patient. Customizing the procedure for every patient is even more important today mainly because the refractive aspect of cataract surgery is increasingly important to patients.

I use a variety of IOL models. I am impressed by the platforms that are available from Teleon Surgical, including the LENTIS (Comfort and Mplus), ACUNEX (Vario and Variomax), and FEMTIS IOLs.

IOL MATERIAL

IOL characteristics, including lens material, can influence the outcomes of cataract surgery. IOL material can also play a role in the prevention of posterior capsular opacification (PCO).¹ The two most common types of IOL material are hydrophilic and hydrophobic, and both types have advantages and disadvantages.

With hydrophilic lenses, PCO might develop earlier compared to with hydrophobic acrylate lenses.² In my viewpoint, the gold standard in IOL material is therefore hydrophobic. As a vitreoretinal surgeon, another reason that I prefer hydrophobic IOLs is because this type of IOL

will not complicate the surgical course in the event I need to perform a silicone oil tamponade. On the other hand, hydrophilic IOLs provide better contrast sensitivity postoperatively because it does not cause as many visual disturbances.

MAKING THE BEST CHOICE

For younger patients in their 50s and 60s, I prefer implanting a hydrophobic glistening-free acrylate IOL (ACUNEX Vario, Teleon Surgical; Figure 1) because there is a greater chance that the IOL will be in the eye for a longer time than it would for an older patient.

On the other hand, I have implanted a lot of hydrophilic IOLs, including the LENTIS Comfort (Figure 2) and Mplus IOLs (Teleon Surgical), in patients with retinal disease, such as those with well-controlled diabetic macular edema.

I also prefer the hydrophilic LENTIS Mplus MF30 in myopic patients. The asymmetrical optic of the Mplus provides very good near and intermediate vision. The Mplus MF20 is best suited for patients who are looking for a multifocal IOL but also require very good distance and intermediate vision. The contrast with the MF20 is better than it is with other multifocal IOLs on the market.

I also use the FEMTIS IOL on occasion; my use of this lens is discussed later.

Courtesy of Teleon Surgical

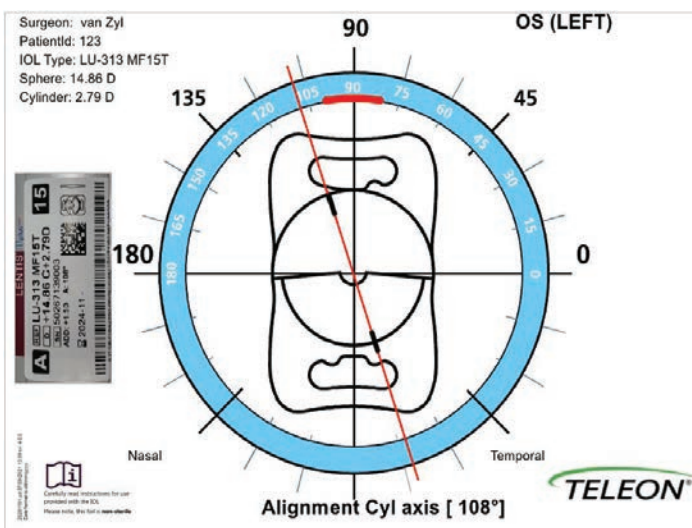

Figure 2. Example of a custom IOL with 14.86 D of sphere and 2.79 D of cylinder.

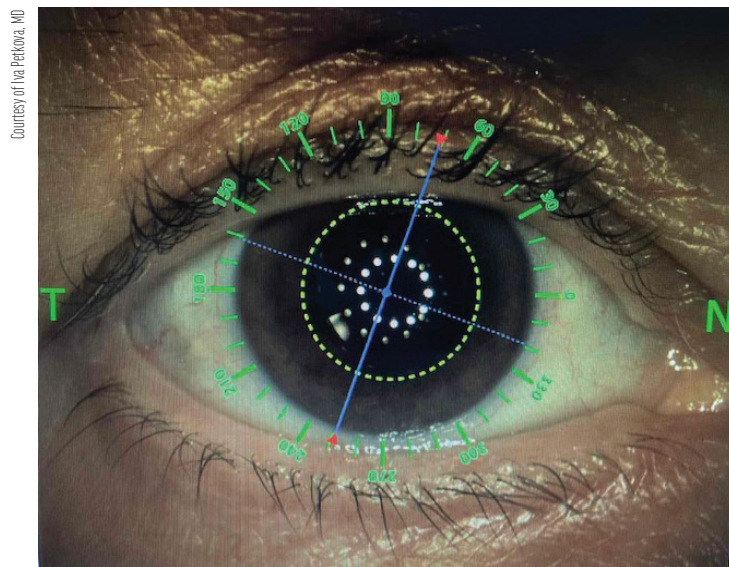

Figure 1. The ACUNEX Vario.



Figure 2. The LENTIS Comfort and LENTIS Comfort Toric IOLs.

Courtesy of Teleon Surgical



Courtesy of Iva Petkova, MD

Figure 3. Centration of a toric IOL.

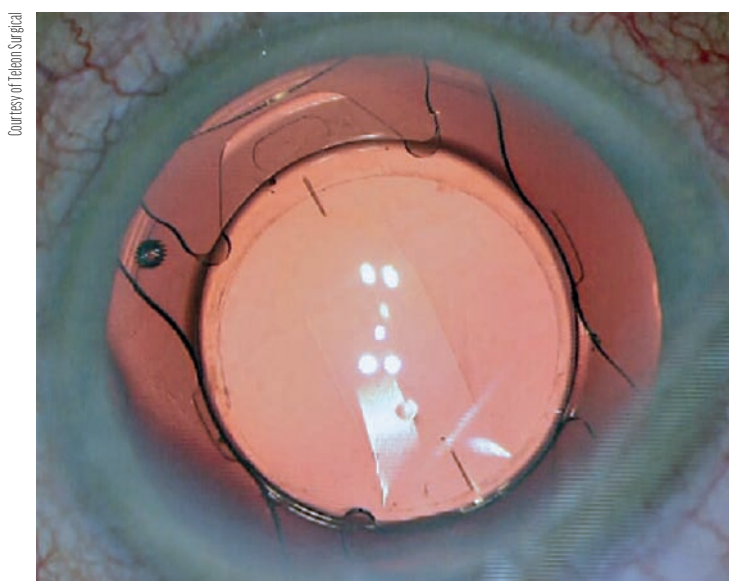

Courtesy of Teleon Surgical

Figure 4. FEMTIS toric IOL in situ.

HAPTIC CONFIGURATIONS

A variety of haptic configurations are also available, including C-loop and plate-haptic designs. In most instances, I prefer the C-loop design of the ACUNEX Vario, as I find it to be extremely stable in the capsular bag. The plate-haptic configuration of the LENTIS Comfort and its toric versions, however, is fairly stable as

well. I am confident that wherever I implant these lenses, they will stay put and remain stable.

Lens stability is extremely important, especially with a toric IOL (Figure 3). In patients with slight myopia, however, centration can be challenging because the capsular bag in these eyes is bigger, and the IOL tends to rotate postoperatively. This is typically noticeable by 10 to 12 days after surgery. Therefore, in patients with myopia and astigmatism, the FEMTIS IOL is an appropriate choice (Figure 4). This IOL, which is designed to clamp into the automated capsulotomy, has two standard plate haptics and four additional haptics that are enclaved in front of the capsulotomy. This eliminates the risk for the lens to dislocate postoperatively by becoming decentered or tilted.

To date, I have implanted about 40 plate-haptic toric IOLs, and I have implanted about 50 C-loop ACUNEX Vario Toric IOLs. The latter IOL is extremely stable in the capsular bag, even in eyes with slight myopia, thanks to its C-loop haptic design. I am extremely happy with my experience with the ACUNEX Vario. I have found that warming the IOL material prior to loading the IOL into the injector is beneficial. This helps the IOL to better unfold in a controlled manner. The lens can then be rotated more easily into the correct position.

Regarding injectors, all Teleon Surgical's hydrophobic IOLs can be loaded into the Accuject 2.1-BL (Medcel), and all Teleon Surgical's hydrophilic IOLs can be loaded into the Viscoject Bio 2.2 (Medcel).

CONCLUSION

Lens material, haptic configuration, and optic design are all important considerations with extended depth of focus and multifocal IOLs such as the LENTIS Comfort, LENTIS Mplus, ACUNEX Vario and Variomax, and FEMTIS IOLs. My experience with these lens platforms is positive, and I truly believe that having myriad options to choose between helps to create the best patient experience. Customizing the procedure to their history, lifestyle, and visual needs is mandatory in today's refractive cataract surgery atmosphere. ■

1. Linnola RJ, Werner L, Pandey SK, et al. Adhesion of fibronectin, vitronectin, laminin, and collagen type IV to intraocular lens materials in pseudophakic human autopsy eyes. Part 1: histological sections. *J Cataract Refract Surg.* 2000;26:1792-1806.
2. Werner L. Causes of intraocular lens opacification or discoloration. *J Cataract Refract Surg.* 2007;33:713-726.

IVA PETKOVA, MD

- Owner, Eye Hospital Zora, Sofia, Bulgaria
- ivapetkova@abv.bg
- Financial disclosure: None