



Augen Instrumente

Ophthalmic Surgical Instruments

Instrumentos para oftalmología

Instruments de Chirurgie Ophtalmologique

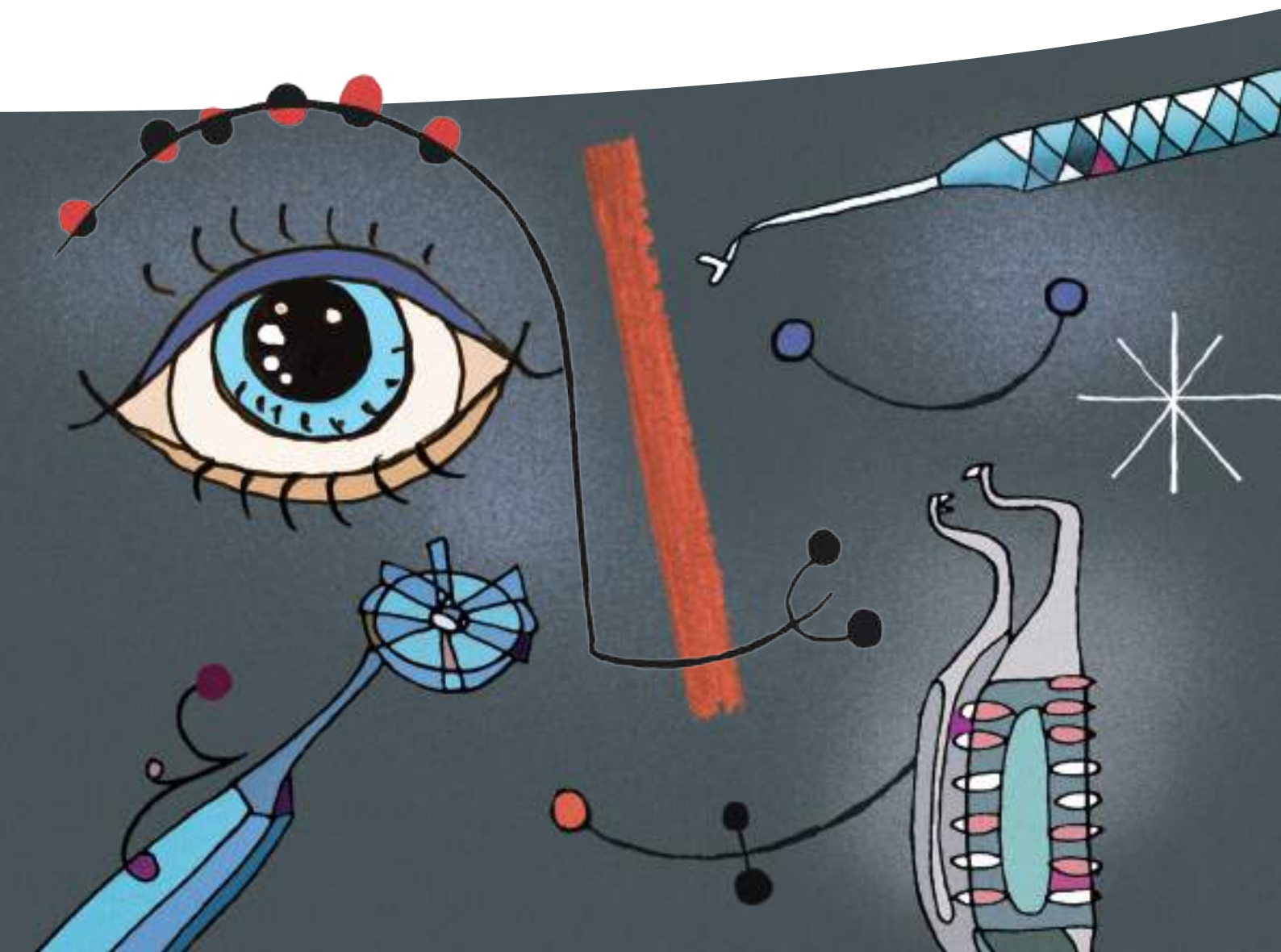

# Augen Instrumente

## Ophthalmic Surgical Instruments

### Instrumentos para oftalmología

### Instruments de Chirurgie Ophtalmologique

#### Allgemeine Hinweise | Legal note | Nota legal | Note legale

Mit Erscheinen dieses Kataloges, der zugehörigen Preisliste und evtl. später nachgelieferter Einzelblätter, verlieren alle zuvor erschienenen Informationen Ihre Gültigkeit.

Änderungen in technischen Details, sowie in Größe und Form der Instrumente bleiben dem Hersteller vorbehalten.

Inhalt und Gestaltung des Kataloges sind urheberrechtlich geschützt und dürfen, auch auszugsweise, ohne die ausdrückliche, schriftliche Genehmigung von Albert Heiss GmbH & Co. KG nicht vervielfältigt oder anderweitig verwendet werden.

Previous editions of catalogues, information sheets, price lists etc. are no longer valid. The same is true for all those information which may be issued later.

The manufacturer reserves the right to make changes in technical details as well as in the size and design of the instruments.

Content and layout of the catalogue are protected by copyright. Neither the catalogue as a whole nor extracts from it may be duplicated or used for any other purpose without the written permission of the company Albert Heiss GmbH & Co. KG.

Con la publicación del presente catálogo, la pertinente lista de precios y las hojas adicionales que se suministren eventualmente con posterioridad, todas las informaciones publicadas con anterioridad pierden su validez.

El fabricante se reserva el derecho de modificaciones y/o alteraciones en lo referente a detalles técnicos y en cuanto a tamaño y forma de los instrumentos.

Contenido y presentación del catálogo están bajo la protección de los derechos de autor, por lo que no se permite – tampoco en extracto – multicopiarlos o emplearlos de otra manera sin la autorización por escrito de Albert Heiss GmbH & Co. KG.

Toutes les éditions précédentes de nos catalogues, documents d'information, tarifs etc. perdent leur validité. Cette règle s'appliquera pour toute information ou mise à jour à venir.



Le fabricant se réserve le droit de procéder à toute modification technique de la taille ou de la forme des instruments.

Le contenu et la mise en page du catalogue sont protégés par des droits d'auteur exclusifs. Ne peuvent faire l'objet d'aucune reproduction ou ne peuvent être utilisés à d'autres fins, ni le catalogue dans sa globalité, ni aucun de ses extraits, sans le consentement par écrit de la société Albert Heiss GmbH & Co. KG.

Albert Heiss GmbH & Co. KG  
Augen Instrumente  
Ophthalmic Surgical Instruments  
Instrumentos para oftalmología  
Instruments de Chirurgie Ophtalmologique

Stockacher Straße 138  
D-78532 Tuttlingen  
Tel.: +49 7461 2527  
Fax: +49 7461 12229  
E-mail: sales@albert-heiss.de

		Kapitel Chapter Capítulo Chapitre	Seite Page Pagina Page
	<b>1</b>	Lidsperrer & Retraktoren Speculas & Retractors Blefaróstatos y retractores Blépharostat et ecarteur	7
	<b>2</b>	Scharfe Instrumente Sharp instruments Instrumentos cortantes Instruments tranchants	35
	<b>3</b>	Spatel & Manipulatoren Spatulas & Manipulators Espatulas y manipuladores Spatules et manipulateurs	59
	<b>4</b>	Pinzetten Forceps Pinzas Pinces	85
	<b>5</b>	Scheren Scissors Tijeras Ciseaux	131
	<b>6</b>	Titaninstrumente Titanium instruments Instrumentos titanio Instruments titane	153
	<b>7</b>	Nadelhalter Needle holders Porta-agujas Porte-aiguilles	165

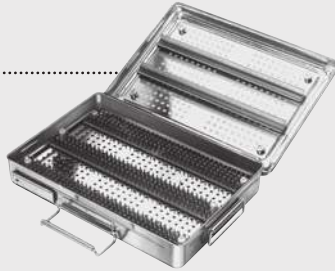
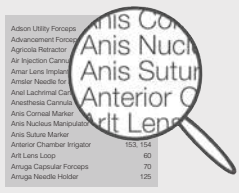
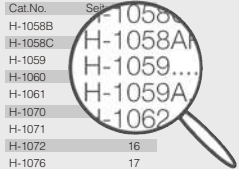
	Kapitel Chapter Capítulo Chapitre	Seite Page Pagina Page
 <h1 style="font-size: 48px; margin-left: 350px;">8</h1>	Tränenweg Instrumente Verschiedene Instrumente Lachrymal instruments Miscellaneous instruments Instrumentos para lacrimal Instrumentos diversos Instruments des voies lacrymales Instruments divers	177
 <h1 style="font-size: 48px; margin-left: 350px;">9</h1>	Mess- & Markierinstrumente Measuring & Marking instruments Compás y marcadores Compas et marqueurs	187
 <h1 style="font-size: 48px; margin-left: 350px;">10</h1>	Kanülen Cannulas Cánulas Canules	197
 <h1 style="font-size: 48px; margin-left: 350px;">11</h1>	Sterilisierbehälter Sterilizing cases Cajas para esterilización Boîtes de stérilisation	213
 <h1 style="font-size: 48px; margin-left: 350px;">12</h1>	Sachwortregister, alphabetisch Alphabetical index Índice alfabético Index alphabétique	217
 <h1 style="font-size: 48px; margin-left: 350px;">13</h1>	Artikelnummer Verzeichnis Numerical index Índice numérico Index numérique	235





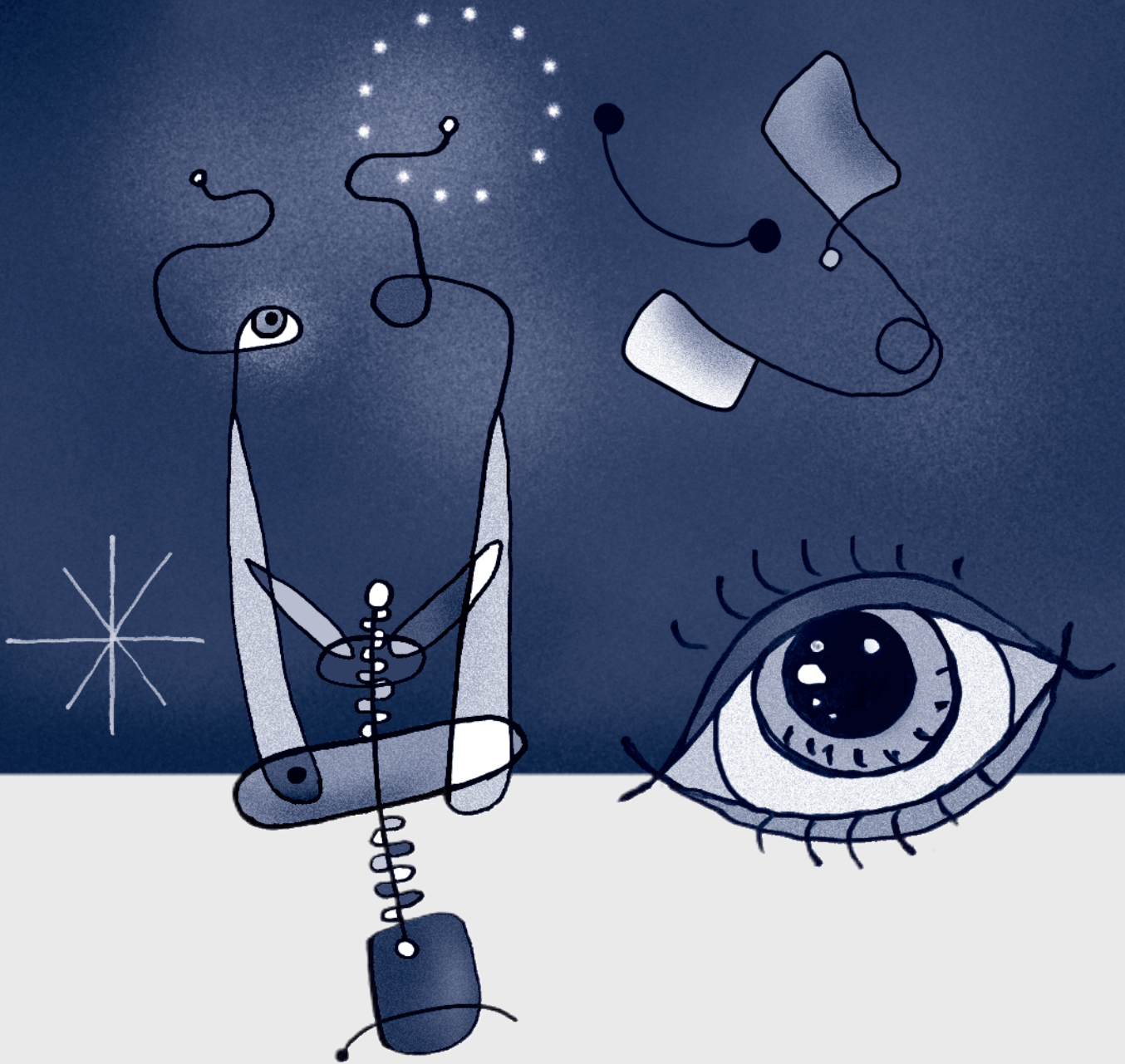

# 1

- Lidsperrer & Retraktoren
- Speculas & Retractors
- Blefaróstatos y retractores
- Blépharostat et ecarteur



**H-1010 Williams**  
Lidsperrer, für Erwachsene  
Eye speculum, adult size  
Blefaróstato, para adultos  
Blépharostat, pour adultes



**H-1015 Lester-Burch**  
Lidsperrer  
Eye speculum  
Blefaróstato  
Blépharostat



**H-1025 Clark**  
Lidsperrer  
Eye speculum  
Blefaróstato  
Blépharostat

**H-1011 Williams**  
Lidsperrer, für Kinder  
Eye speculum, child size  
Blefaróstato, para niños  
Blépharostat, pour enfants



**H-1005 Barrett**  
Lidsperrer, 15 mm  
nasale Biegung  
Eye speculum, 15 mm  
for nasal placement  
Blefaróstato, 15 mm  
para incisiones temporales  
Blépharostat, 15 mm  
pour incisions temporales



**H-1035 Lancaster**  
Lidsperrer  
Eye speculum  
Blefaróstato  
Blépharostat



**H-1037 Corcelle**  
Lidsperrer  
Eye speculum  
Blefaróstato  
Blépharostat



**H-1040 Mellinger**  
 Lidsperrer, volle Blätter  
 Eye speculum, solid blades  
 Blefaróstato, macizo  
 Blépharostat, plein

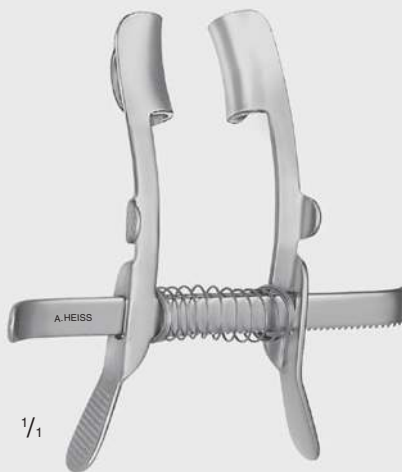

**H-1040A Mellinger**  
 Lidsperrer, volle Blätter, für Kinder  
 Eye speculum, solid blades, for children  
 Blefaróstato, macizo, para niños  
 Blépharostat, plein, pour enfants



**H-1041 Mellinger**  
 Lidsperrer, gefenstert  
 Eye speculum, fenestrated  
 Blefaróstato, fenestrado  
 Blépharostat, fenêtré

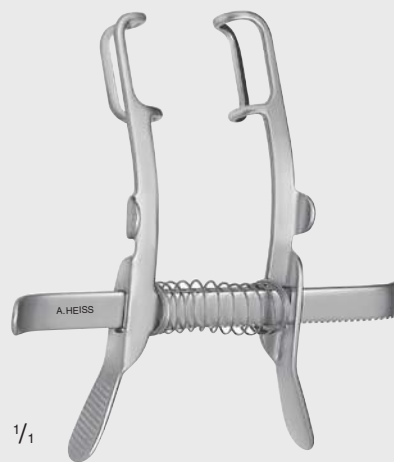

**H-1041A Mellinger**  
 Lidsperrer, gefenstert,  
 für Kinder  
 Eye speculum, fenestrated,  
 for children  
 Blefaróstato, fenestrado,  
 para niños  
 Blépharostat, fenêtré,  
 pour enfants



**H-1044 Mellinger**  
 Lidsperrer,  
 15 mm, offene Valve  
 Eye speculum,  
 15 mm, open valve  
 Blefaróstato,  
 palas abiertas de 15 mm  
 Blépharostat,  
 oreilles ouvertes de 15 mm



**H-1045 Weiss**  
Lidsperrer, gefenstert, für Erwachsene  
Eye speculum, fenestrated, adult size  
Blefaróstato, fenestrado, para adultos  
Blépharostat, fenêtré, pour adultes



**H-1047 Weiss**  
Lidsperrer, volle Blätter, für Erwachsene  
Eye speculum, solid blades, adult size  
Blefaróstato, macizo, para adultos  
Blépharostat, plein, pour adultes

**H-1046 Weiss**  
Lidsperrer, gefenstert, für Kinder  
Eye speculum, fenestrated, child size  
Blefaróstato, fenestrado, para niños  
Blépharostat, fenêtré, pour enfants

**H-1048 Weiss**  
Lidsperrer, volle Blätter, für Kinder  
Eye speculum, solid blades, child size  
Blefaróstato, macizo, para niños  
Blépharostat, plein, pour enfants

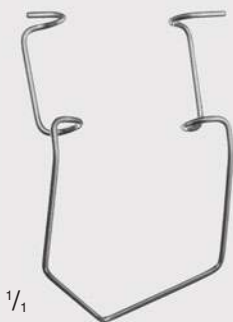

**H-1049 Kratz-Barraquer**  
Lidsperrer, groß,  
starker Draht  
Eye speculum, large,  
heavy wire  
Blefaróstato, grande,  
alambre fuerte  
Blépharostat, grand,  
ressort fort

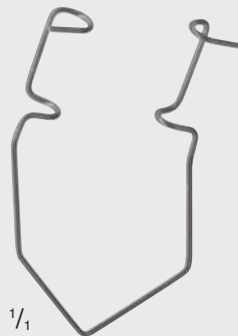

**H-1049N Kratz-Barraquer**  
Lidsperrer, groß,  
starker Draht, temporal  
Eye speculum, large,  
heavy wire, temporal  
Blefaróstato, grande,  
alambre fuerte, temporal  
Blépharostat, grand,  
ressort fort, temporal

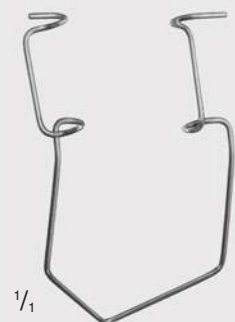

**H-1050R Kratz**  
Drahtlidsperrer,  
nasale Biegung  
Wire Eye Speculum,  
for nasal placement  
Blefarostat oblícuo,  
para incisiones temporales  
Blépharostat, grand, standard,  
pour incisions temporales

**H-1050** Standard    standard  
standard    standard



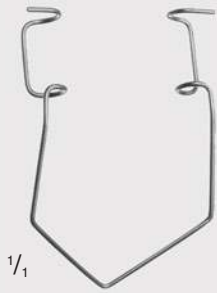

**H-1051 Kratz-Barraquer**

Lidsperrer, klein, Standard  
Eye speculum, small, standard  
Blefaróstato, pequeño, standard  
Blépharostat, petit, standard

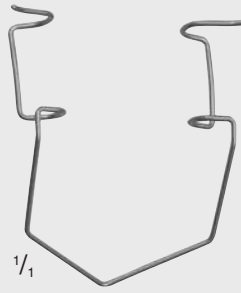

**H-1051A Kratz-Barraquer**

Lidsperrer, klein, Standard  
Eye speculum, small, standard  
Blefaróstato, pequeño, standard  
Blépharostat, petit, standard



**H-1066A Barraquer-Oosterhuis**

Lidsperrer, volle Blätter,  
verstellbar  
Eye speculum, solid blades,  
adjustable  
Blefaróstato, macizo,  
ajustable  
Blépharostat, plein,  
ajustable



**H-1066B Barraquer-Oosterhuis**

Lidsperrer, volle Blätter,  
verstellbar, für Kinder  
Eye speculum, solid blades,  
adjustable, baby size  
Blefaróstato, macizo,  
ajustable, para niños  
Blépharostat, plein,  
ajustable, pour enfants



**H-1066C Neuhann**

Lidsperrer, volle Blätter,  
verstellbar  
Eye speculum, solid blades,  
adjustable  
Blefaróstato, macizo,  
ajustable  
Blépharostat, plein,  
ajustable

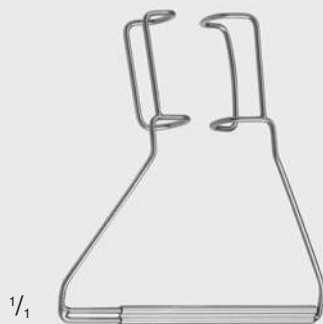

**H-1067A Barraquer-Oosterhuis**

Lidsperrer, gefenstert,  
verstellbar  
Eye speculum, fenestrated,  
adjustable  
Blefaróstato, fenestrado,  
ajustable  
Blépharostat, fenêtré,  
ajustable



**H-1067B Barraquer-Oosterhuis**

Lidsperrer, gefenstert,  
verstellbar, für Kinder  
Eye speculum, fenestrated,  
adjustable, baby size  
Blefaróstato, fenestrado,  
ajustable, para niños  
Blépharostat, fenêtré,  
ajustable, pour enfants



**H-1068 Barraquer-Oosterhuis-Kratz**

Lidsperrer, gefenstert,  
verstellbar  
Eye speculum, fenestrated,  
adjustable  
Blefaróstato, fenestrado,  
ajustable  
Blépharostat, fenêtré,  
ajustable



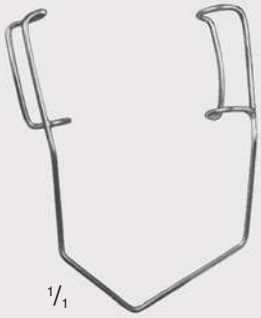

**H-1058A Barraquer**  
Lidsperrer, für Erwachsene  
Eye speculum, adult size  
Blefaróstato, para adultos  
Blépharostat, pour adultes

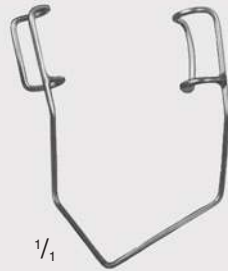

**H-1058B Barraquer**  
für Kinder  
child size  
para niños  
pour enfants

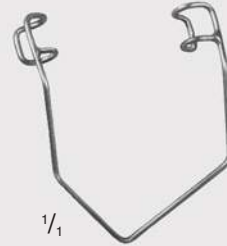

**H-1058C Barraquer**  
für Säuglinge  
baby size  
para niños de pecho  
pour bébés

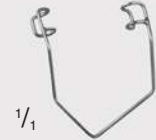

**H-1058D Barraquer**  
für Frühgeborene  
for premature infants  
para niño prematuro  
pour bébés prématuré

**H-1058A-0.9 Barraquer**  
Lidsperrer, für Erwachsene,  
starker Draht  
Eye speculum, adult size,  
heavy wire  
Blefaróstato, para adultos,  
alambre fuerte  
Blépharostat, pour adultes,  
ressort fort

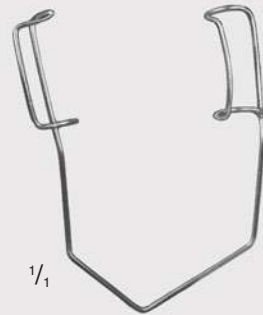

**H-1058AR Barraquer**  
Drahtlidsperrer, nasale Biegung  
Wire eye speculum, for nasal placement  
Blefarostato oblícuo, para incisiones temporales  
Blépharostat pour adultes, pour incisions temporales

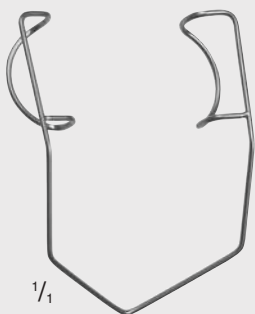

**H-1001A Barraquer**  
Lidsperrer, 15 mm  
Eye speculum, 15 mm  
Blefaróstato, 15 mm  
Blépharostat, 15 mm

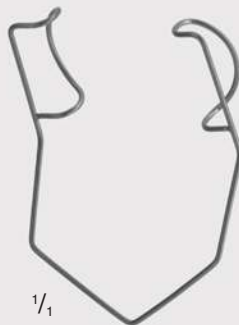

**H-1001AR Barraquer**  
Lidsperrer, 15 mm  
nasale Biegung  
Eye speculum, 15 mm  
for nasal placement  
Blefaróstato, 15 mm  
para incisiones temporales  
Blépharostat, 15 mm  
pour incisions temporales

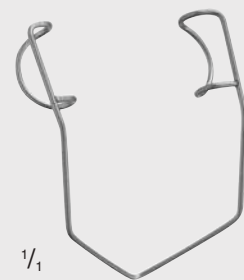

**H-1001B Barraquer**  
Lidsperrer, 10 mm  
Eye speculum, 10 mm  
Blefaróstato, 10 mm  
Blépharostat, 10 mm



**H-1059 Barraquer**  
 Lidsperrer, volle Blätter  
 Eye speculum, solid blades  
 Blefaróstat, macizo  
 Blépharostat, plein



**H-1059A Barraquer**  
 Lidsperrer, volle Blätter, klein  
 Eye speculum, solid blades, small  
 Blefaróstat, macizo, pequeño  
 Blépharostat, plein

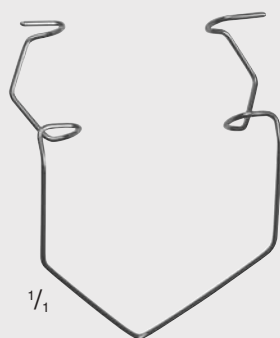

**H-1012A McIntyre**  
 Drahtlidsperrer, 13 mm  
 Wire speculum, 13 mm  
 Blefaróstat, 13 mm  
 Blépharostat, 13 mm

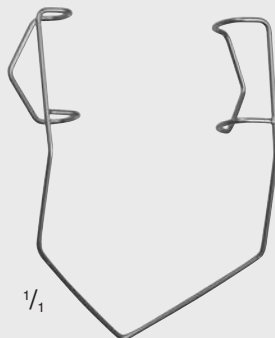

**H-1012B McIntyre**  
 Drahtlidsperrer,  
 geschlossene Valve, 13 mm  
 Wire speculum,  
 closed wire, 13 mm  
 Blefaróstat, 13 mm  
 Blépharostat, 13 mm

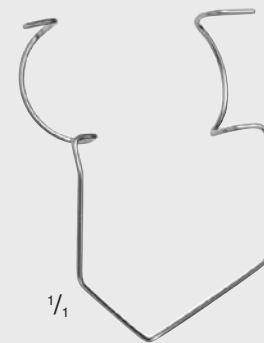

**H-1062 Kratz**  
 Lidsperrer, Standard  
 Eye speculum, standard  
 Blefaróstat, standard  
 Blépharostat, standard

**H-1062A** starker Draht    alambre fuerte  
 heavy wire    ressort fort



**H-1063L Kratz**  
 Lidsperrer, Standard  
 für das linke Auge  
 Eye speculum, standard  
 for the left eye  
 Blefaróstat, standard  
 para el ojo izquierdo  
 Blépharostat, standard  
 pour l'œil gauche

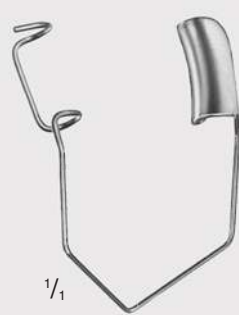

**H-1063R Kratz**  
 Lidsperrer, Standard  
 für das rechte Auge  
 Eye speculum, standard  
 for the right eye  
 Blefaróstat, standard  
 para el ojo derecho  
 Blépharostat, standard  
 pour l'œil droit



**H-1098 Alfonso**  
 Lidsperrer für Neugeborene,  
 5 / 8 mm Valve  
 Eye speculum for new born  
 babies, 5 / 8 mm open blades  
 Blefaróstat, para niños de  
 pecho, 5 / 8 mm  
 Blépharostat, pour bébés,  
 5 / 8 mm

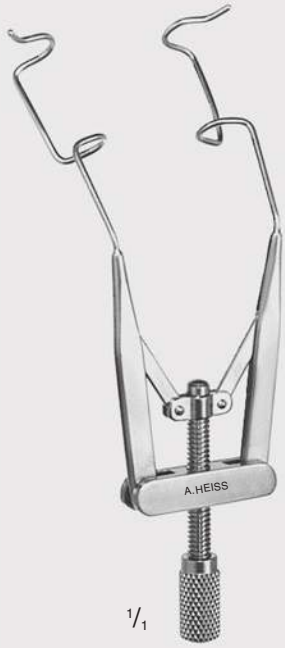

**H-1052 Liebermann**  
Lidsperrer, K-wire  
Eye speculum, K-wire  
Blefaróstato, K-wire  
Blépharostat, K-wire

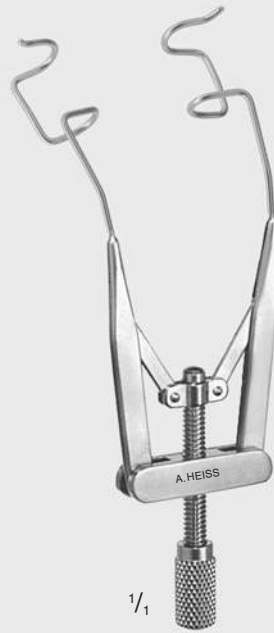

**H-1052A Liebermann**  
Lidsperrer, K-wire  
für Kinder  
Eye speculum, K-wire,  
for children  
Blefaróstato, K-wire,  
para niños  
Blépharostat, K-wire,  
pour enfants



**H-1052N Liebermann**  
Lidsperrer, K-wire,  
nasale Biegung  
Eye speculum, K-wire,  
for nasal placement  
Blefaróstato, K-wire,  
para incisiones temporales  
Blépharostat, K-wire,  
pour incisions temporales



**H-1052S Liebermann**  
Lidsperrer, K-wire, gerade  
Eye speculum, K-wire, straight  
Blefaróstato, K-wire, recta  
Blépharostat, K-wire, droit



**H-1053 Liebermann**  
Lidsperrer, V-wire  
Eye speculum, V-wire  
Blefaróstato, V-wire  
Blépharostat, V-Wire



**H-1019 Wiltfang**  
Lidsperrer, gefenstert  
Eye speculum, fenestrated  
Blefaróstato, fenestrado  
Blépharostat, fenêtré



**H-1054 Liebermann**  
Lidsperrer, volle Blätter  
Eye speculum, solid blades  
Blefaróstato, macizo  
Blépharostat, plein



**H-1054A Liebermann**  
volle Blätter, für Kinder  
solid blades, for children  
macizo, para niños  
plein, pour enfants

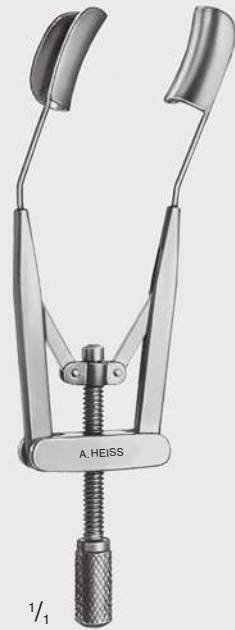

**H-1054N Liebermann**  
volle Blätter,  
nasale Biegung  
solid blades,  
for nasal approach  
macizo, para  
incisiones temporales  
plein, pour  
incisions temporales



**H-1056 Kershner**  
 Lidsperrer, gefenstert  
 Eye speculum, fenestrated  
 Blefaróstato, fenestrado  
 Blépharostat, fenêtré



**H-1057 Kershner**  
 Lidsperrer, volle Blätter,  
 nasal & temporal  
 Eye speculum, solid blades,  
 for nasal and temporal  
 placement  
 Blefaróstato, macizo,  
 para la colocación nasal  
 y temporal  
 Blépharostat, plein,  
 pour placement nasal  
 et temporal



**H-1008 Pley**  
 Lidsperrer, volle Blätter,  
 nasal & temporal  
 Eye speculum, solid blades,  
 for nasal and temporal  
 placement  
 Blefaróstato, macizo,  
 para la colocación nasal  
 y temporal  
 Blépharostat, plein,  
 pour placement nasal  
 et temporal



**H-1064 Thorlakson**  
 Lidsperrer, O-wire  
 Eye speculum, O-wire  
 Blefaróstato, O-wire  
 Blépharostat, O-wire

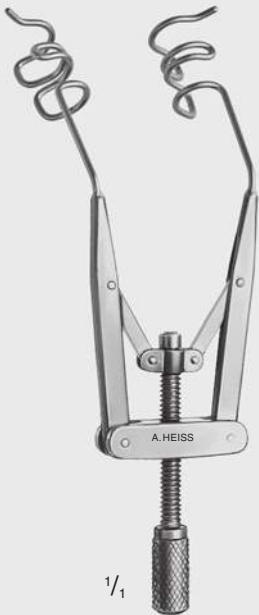

1/1

**H-1082** Lidsperrer, dreifach Stütze  
 Eye speculum, triple post  
 Blefaróstato, triple post  
 Blépharostat, triple post



1/1

**H-1083 Liebermann**  
 Lidsperrer, mit Öhr  
 zur Fadenfixierung  
 Eye speculum, with  
 traction suture anchor posts  
 Blefaróstato con ancalajes  
 para sutura  
 Blépharostat avec des  
 acres de suture

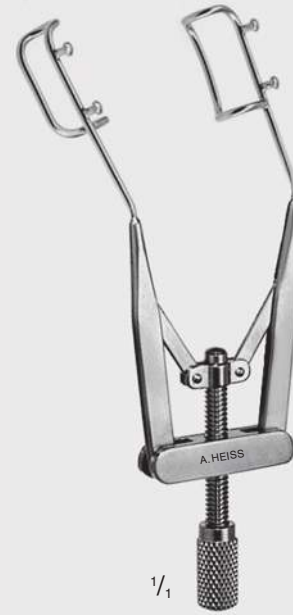

1/1

**H-1084 Sharawy**  
 Lidsperrer, mit Öhr  
 zur Fadenfixierung  
 Eye speculum, with  
 traction suture anchor posts  
 Blefaróstato con ancalajes  
 para sutura  
 Blépharostat avec des  
 acres de suture



1/1

**H-1055 Sauer**  
 Lidsperrer, für Kinder  
 Eye speculum, child size  
 Blefaróstato, para niños  
 Blépharostat, pour enfants



1/1

**H-1055A Sauer**  
 Lidsperrer,  
 für Säuglinge  
 Eye speculum,  
 baby size  
 Blefaróstato,  
 para niños de pecho  
 Blépharostat,  
 pour bébés



1/1

**H-1074 Frankel**  
 Lidsperrer  
 Eye speculum  
 Blefaróstato  
 Blépharostat





1/1

**H-1020 Liebermann**  
 Lidsperrer mit  
 Aspiration, K-wire  
 Eye speculum  
 with aspiration, K-wire  
 Blefaróstato  
 con aspiración, K-wire  
 Blépharostat  
 avec aspiration, K-wire



1/1

**H-1021 Liebermann**  
 Lidsperrer mit  
 Aspiration, V-wire  
 Eye speculum  
 with aspiration, V-wire  
 Blefaróstato  
 con aspiración, V-wire  
 Blépharostat  
 avec aspiration, V-wire



1/1

**H-1022 Wiltfang**  
 Lidsperrer  
 mit Aspiration  
 Eye speculum  
 with aspiration  
 Blefaróstato  
 con aspiración  
 Blépharostat  
 avec aspiration



1/1

**H-1023 Knorz**  
 Lidsperrer  
 mit Aspiration  
 Eye speculum  
 with aspiration  
 Blefaróstato  
 con aspiración  
 Blépharostat  
 avec aspiration



1/1

**H-1024 Chu**  
 Lidsperrer mit Aspiration,  
 volle Blätter  
 Eye speculum with aspiration,  
 solid blades  
 Blefaróstato con aspiración,  
 macizo  
 Blépharostat avec aspiration,  
 plein



1/1

**H-1026** Lidsperrer mit Aspiration,  
 geschlitzt  
 Eye speculum with  
 aspiration  
 Blefaróstato  
 con aspiración  
 Blépharostat  
 avec aspiration

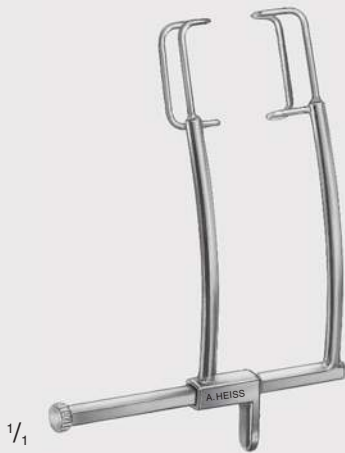

**H-1060 Murdock**  
 Lidsperrer, für Erwachsene  
 Eye speculum, adult size  
 Blefaróstato, para adultos  
 Blépharostat, pour adultes

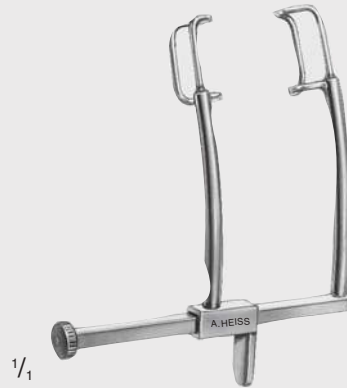

**H-1061 Murdock**  
 Lidsperrer, für Kinder  
 Eye speculum, child size  
 Blefaróstato, para niños  
 Blépharostat, pour enfants



**H-1070 Cook**  
 Lidsperrer, groß, 15 mm  
 Eye speculum, large, 15 mm  
 Blefaróstato, grande, 15 mm  
 Blépharostat, grand, 15 mm



**H-1071 Cook**  
 Lidsperrer, mittel, 11 mm  
 Eye speculum, medium, 11 mm  
 Blefaróstato, mediano, 11 mm  
 Blépharostat, moyen, 11 mm



**H-1072 Cook**  
 Lidsperrer, klein, 7.5 mm  
 Eye speculum, small, 7.5 mm  
 Blefaróstato, pequeño, 7.5 mm  
 Blépharostat, petit, 7.5 mm



**H-1073 Cook**  
 Lidsperrer, für Säuglinge, 5 mm  
 Eye speculum, baby size, 5 mm  
 Blefaróstato, para niños de pecho, 5 mm  
 Blépharostat, pour bébés, 5 mm



**H-1076 Scott**  
 Lidsperrer, für Erwachsene, gefensterte Blätter  
 Eye speculum, for adults, fenestrated blades  
 Blefaróstato, para adultos, fenestrado  
 Blépharostat, pour adultes, fenêtré



**H-1085 Park**  
 Lidsperrer,  
 gefensterte Blätter  
 Eye speculum,  
 fenestrated blades  
 Blefaróstato, fenestrado  
 Blépharostat, fenêtré



**H-1090 Park-Guyton**  
 Lidsperrer,  
 gefensterte Blätter  
 Eye speculum,  
 fenestrated blades  
 Blefaróstato, fenestrado  
 Blépharostat, fenêtré



**H-1092 Park-Maumenee**  
 Lidsperrer,  
 gefensterte Blätter  
 Eye speculum,  
 fenestrated blades  
 Blefaróstato, fenestrado  
 Blépharostat, fenêtré



**H-1078L Bangarter**  
Lidsperrer, links  
Eye speculum, left  
Blefaróstato, izquierdo  
Blépharostat, gauche



**H-1094 Castroviejo**  
Lidsperrer, mittel, 16 mm  
Eye speculum, medium, 16 mm  
Blefaróstato, mediano, 16 mm  
Blépharostat, moyen, 16 mm



**H-1095 Castroviejo**  
Lidsperrer, klein, 14 mm  
Eye speculum, small, 14 mm  
Blefaróstato, pequeño, 14 mm  
Blépharostat, petit, 14 mm

**H-1078R Bangarter**  
Lidsperrer, rechts  
Eye speculum, right  
Blefaróstato, derecho  
Blépharostat, droite

**H-1096 Castroviejo**  
Lidsperrer, mittel, 16 mm  
Eye speculum, medium, 16 mm  
Blefaróstato, mediano, 16 mm  
Blépharostat, moyen, 16 mm



**H-1099 Shapira**  
Lidsperrer  
Eye speculum  
Blefaróstato  
Blépharostat



**H-1105 Axenfeld**  
Wundspreizer für den Tränensack  
Lacrimal sack retractor  
Separador para el saco lacrimal  
Ecarteur pour le sac lacrymal

**H-1097 Castroviejo**  
Lidsperrer, groß, 18 mm  
Eye speculum, large, 18 mm  
Blefaróstato, grande, 18 mm  
Blépharostat, grand, 18 mm



**H-1100 Agricola**  
 Wundspreizer  
 für den Tränensack  
 Lacrimal sack retractor  
 Separador para  
 el saco lacrimal  
 Ecarteur pour le  
 sac lacrymal

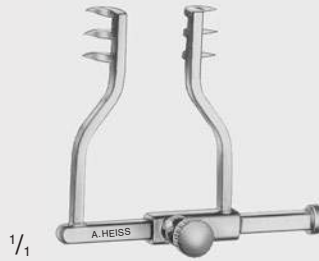

**H-1110 Goldstein**  
 Wundspreizer  
 für den Tränensack  
 Lacrimal sack retractor  
 Separador para  
 el saco lacrimal  
 Ecarteur pour le  
 sac lacrymal

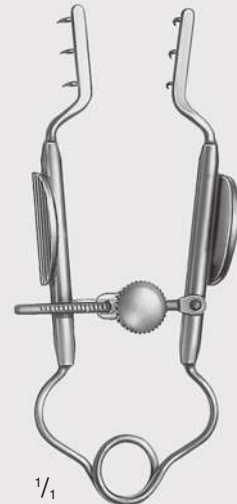

**H-1115 Mueller**  
 Wundspreizer  
 für den Tränensack  
 Lacrimal sack retractor  
 Separador para  
 el saco lacrimal  
 Ecarteur pour le  
 sac lacrymal



**H-1120 Stevenson**  
 Wundspreizer  
 für den Tränensack  
 Lacrimal sack retractor  
 Separador para  
 el saco lacrimal  
 Ecarteur pour le  
 sac lacrymal



**H-1121 Heiss**  
 Wundspreizer  
 für den Tränensack, stumpf  
 Lacrimal sack retractor, blunt  
 Separador para  
 el saco lacrimal, romo  
 Ecarteur pour le  
 sac lacrymal, mousse



**H-1122 Heiss**  
 Wundspreizer  
 für den Tränensack, scharf  
 Lacrimal sack retractor, sharp  
 Separador para  
 el saco lacrimal, agudo  
 Ecarteur pour le sac lacrymal,  
 tranchant





**H-1125 Jaffe**  
Lidhalter, groß, Paar  
Lid retractor, large, pair  
Retractor para párpados, grande, un par  
Ecarteur de paupières, fenêtré, grand, pair

**H-1126 Jaffe**  
Lidhalter, klein, Paar  
Lid retractor, small, pair  
Retractor para párpados, pequeño, un par  
Ecarteur de paupières, fenêtré, petit, pair

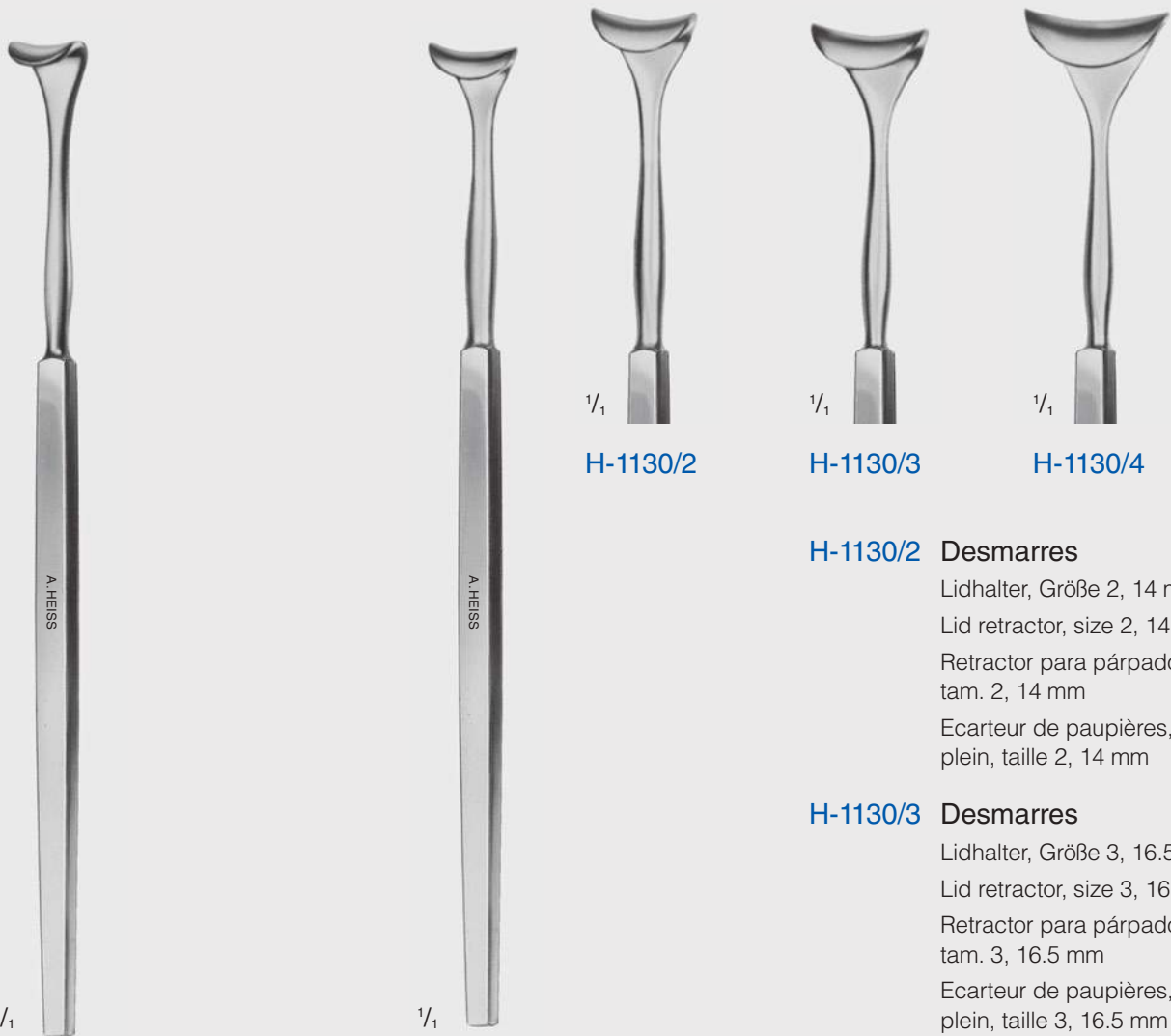

**H-1128 Desmarres**  
Lidhalter, Kinder, 8.7 mm  
Lid retractor, infant, 8.7 mm  
Retractor para párpados, para niños, 8.7 mm  
Ecarteur de paupières, pour enfants, 8.7 mm

**H-1130/1 Desmarres**  
Lidhalter, Größe 1, 12 mm  
Lid retractor, size 1, 12 mm  
Retractor para párpados, tam. 1, 12 mm  
Ecarteur de paupières, plein, taille 1, 12 mm

**H-1130/2 Desmarres**  
Lidhalter, Größe 2, 14 mm  
Lid retractor, size 2, 14 mm  
Retractor para párpados, tam. 2, 14 mm  
Ecarteur de paupières, plein, taille 2, 14 mm

**H-1130/3 Desmarres**  
Lidhalter, Größe 3, 16.5 mm  
Lid retractor, size 3, 16.5 mm  
Retractor para párpados, tam. 3, 16.5 mm  
Ecarteur de paupières, plein, taille 3, 16.5 mm

**H-1130/4 Desmarres**  
Lidhalter, Größe 4, 19 mm  
Lid retractor, size 4, 19 mm  
Retractor para párpados, tam. 4, 19 mm  
Ecarteur de paupières, plein, taille 4, 19 mm



Helveston

**H-1131/1**

Retraktor, 7 mm  
Retractor, 7 mm  
Separador, 7 mm  
Ecarteur, 7 mm

**H-1131/2**

Retraktor, 9 mm  
Retractor, 9 mm  
Separador, 9 mm  
Ecarteur, 9 mm

**H-1131/3**

Retraktor, 11 mm  
Retractor, 11 mm  
Separador, 11 mm  
Ecarteur, 11 mm

1/1

**H-1133**

**Gass**

Sklera Marker 1.5 mm  
Sclera marker 1.5 mm  
Marcador para sclera 1.5 mm  
Marqueur scléral 1.5 mm



1/1

Schepens

**H-1135/1**

Lokalisator 8 mm  
Localisator 8 mm  
Localizador 8 mm  
Dépresseur scléral 8 mm

**H-1135/2**

Lokalisator 10 mm  
Localisator 10 mm  
Localizador 10 mm  
Dépresseur scléral 10 mm

**H-1135/3**

Lokalisator 12 mm  
Localisator 12 mm  
Localizador 12 mm  
Dépresseur scléral 12 mm



1/1

**H-1139**

**Flynn**

Sklera Depressor  
Localisator  
Localizador  
Dépresseur scléral



1/1

**H-1136**

**Schocket**

Lokalisator, doppelt  
Localisator, double-ended  
Localizador, doble  
Dépresseur scléral, double



1/1

**H-1137**

**Laqua**

Lokalisator, doppelt  
Localisator, double-ended  
Localizador, doble  
Dépresseur scléral, double



1/1

**H-1138**

**Kreissig**

Kombi-Deller, doppelseitig  
Localizer, double ended  
Localizador, doble  
Dépresseur scléral, double



1/1

H-1140

**Jaeger**

Lidplatte, Metall  
Spatula, metal  
Placa para párpados, de metal  
Spatule, en métal



H-1805/1

**Guthrie**

Doppelhåkchen, scharf, Fig. 1  
Fixation hook, double, sharp, fig. 1  
Gancho doble para fijación, agudo, tam. 1  
Crochet double à fixation, pointu, fig. 1

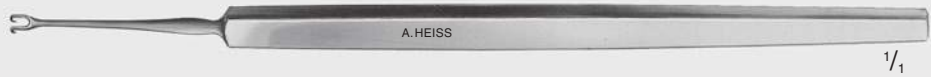

H-1805/2

**Guthrie**

Doppelhåkchen, scharf, fig. 2  
Fixation hook, double, sharp, fig. 2  
Gancho doble para fijación, agudo, tam. 2  
Crochet double à fixation, pointu, fig. 2



H-1810

**Fink**

Muskelhaken, scharf  
Oblique muscle hook, sharp  
Gancho muscular, agudo  
Crochet musculaire, pointu



H-1860

**Beehler**

Pupillendilatator, 20 ga, gerade, 1 Arm für 2-Punkt Dilatation  
Small pupil dilator, 20 ga, straight, 1 finger for 2 point dilation  
Dilatador de pupila, 20 ga, recto, dos puntos de delatación  
Dilatateur de pupille, 20 ga, droit, deux points de dilatation



H-1861

**Beehler**

Pupillendilatator, 18 ga, gerade, 2 Arme für 3-Punkt Dilatation  
Small pupil dilator, 18 ga, straight, 2 fingers for 3 point dilation  
Dilatador de pupila, 18 ga, curvo, 3 puntos de delatación  
Dilatateur de pupille, 18 ga, courbe, 3 points de dilatation



H-1862



**Beehler**

Pupillendilatator, 16 ga, gebogen, 3 Arme für 4-Punkt Dilatation  
Small pupil dilator, 16 ga, curved, 3 fingers for 4 point dilation  
Dilatador de pupila, 16 ga, curvo, 4 puntos de delatación  
Dilatateur de pupille, 16 ga, courbe, 4 points de dilatation



1/1

H-1820

**Rollet**

Tränensackhäkchen, scharf  
Hook for lacrimal sack, sharp  
Gancho para el saco lacrimal, agudo  
Crochet pointu pour le sac lacrymal



1/1

H-1821

**Rollet**

Tränensackhäkchen, stumpf  
Hook for lacrimal sack, blunt  
Gancho para el saco lacrimal, romo  
Crochet mousse pour le sac lacrymal



1/1

H-1825

**Aubaret**

Tränensackhäkchen, scharf  
Hook for lacrimal sack, sharp  
Gancho para el saco lacrimal, agudo  
Crochet pointu pour le sac lacrymal



1/1

**Axenfeld**

Haken, 2 Zinken,  
Hook, 2 prongs  
Gancho, con 2 púas  
Crochet, à 2 griffes



1/1

H-1830

scharf : agudo  
sharp : pointu

H-1832

stumpf : romo  
blunt : mousse

**Axenfeld**

Haken, 3 Zinken,  
Hook, 3 prongs  
Gancho, con 3 púas  
Crochet, à 3 griffes



1/1

H-1840

scharf : agudo  
sharp : pointu

H-1842

stumpf : romo  
blunt : mousse

**Axenfeld**

Haken, 4 Zinken,  
Hook, 4 prongs  
Gancho, con 4 púas  
Crochet, à 4 griffes



1/1

H-1840/4

scharf : agudo  
sharp : pointu

H-1842/4

stumpf : romo  
blunt : mousse

**H-1845** Paul  
Wundhaken, stumpf  
Retractor, blunt  
Separador, romo  
Ecarteur, mousse



1/1

**Jameson**  
Schielhaken  
Strabismus hook  
Gancho para estrabismo  
Crochet à strabisme



1/1

**H-1890** klein : pequeño  
small : petit

**H-1892** groß : grande  
large : grand



1/1

**H-1900/1** Graefe  
Schielhaken, Fig. 1  
Strabismus hook, fig. 1  
Gancho para estrabismo, tam. 1  
Crochet à strabisme, fig. 1



1/1

**H-1900/2** Schielhaken, Fig. 2  
Strabismus hook, fig. 2  
Gancho para estrabismo, tam. 2  
Crochet à strabisme, fig. 2



1/1

**H-1900/3** Schielhaken, Fig. 3  
Strabismus hook, fig. 3  
Gancho para estrabismo, tam. 3  
Crochet à strabisme, fig. 3



1/1

**H-1902** Schielhaken, 12 mm  
Strabismus hook, 12 mm  
Gancho para estrabismo, 12 mm  
Crochet à strabisme, 12 mm

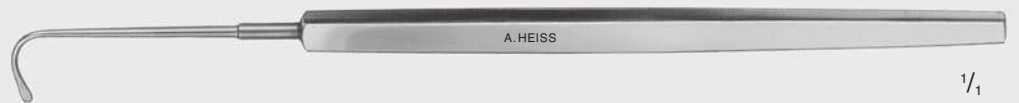

1/1

**H-1903** Gass  
Häkchen bei Netzhautablösung, 13 mm, 1.5 mm ovales Loch  
Retinal detachment hook, 13 mm, 1.5 mm oval hole  
Gancho para desprendimiento de retina, 13 mm, abertura ovalado, 1.5 mm  
Crochet à décollement de rétine, 13 mm, 1.5 mm trou ovale



1/1

H-1905

**Jaeger**

Schielhaken  
Strabismus hook  
Gancho para estrabismo  
Crochet à strabisme

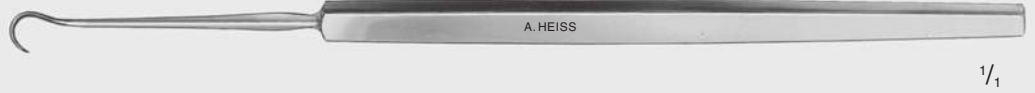

1/1

H-1912

**Green**

Schielhaken  
Strabismus hook  
Gancho para estrabismo  
Crochet à strabisme



1/1

H-1915

**Culler**

Muskelhaken  
Rectus muscle hook  
Gancho muscular  
Crochet musculaire



1/1

H-1920

**Stevens**

Tenotomiehäkchen  
Tenotomy hook  
Gancho para tenotomia  
Crochet à ténotomie

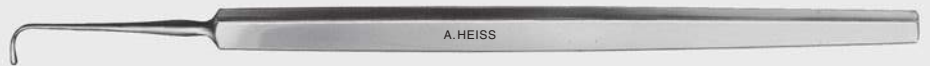

1/1

**Helveston**

Schielhaken, fein  
Muscle hook, delicate  
Gancho de estrabismo, delicado  
Crochet à strabisme, délicate

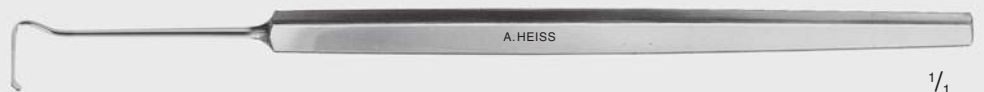

1/1

H-1917

12 mm



1/1

H-1916

10 mm



1/1

H-1918

8 mm



1/1



H-1919

**Helveston**

Häkchen, 6 mm  
Teaser hook, 6 mm  
Gancho de estrabismo muy delicado, 6 mm  
Crochet à strabisme, 6 mm, fins



1/1



1/1

**Helveston**

Muskelhaken, sehr fein  
Muscle hook, very delicate  
Gancho para localizar muy delicado  
Crochet musculaire, fins

H-1921



1/1

H-1922



1/1



1/1

Schielhaken mit Nut  
Grooved strabismus hook with nut  
Gancho para estrabismo con tuerca  
Crochet à strabisme avec noix

H-1895L

links      ····· izquierda  
left        ····· droit

H-1895R

rechts     ····· derecha  
right      ····· gauche

**Sautter**

Orbitalspatel  
 Orbital spatula  
 Espátula orbital  
 Ecarteur-spatule orbitaire

**H-2105**

12 mm

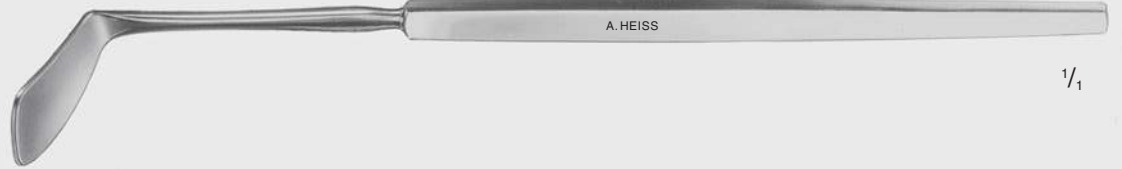

**H-2106**

15 mm



**H-2107**

18 mm



**H-2110**

**Schepens**

Orbitalspatel  
 Orbital retractor  
 Retractor orbital  
 Ecarteur orbitaire



**H-2108**

**Giessen**

Wundspatel  
 Spatula  
 Espátula  
 Spatule

**Flieringa**  
Fixierring  
Fixation ring  
Anillo de fijación  
Anneaux de fixation

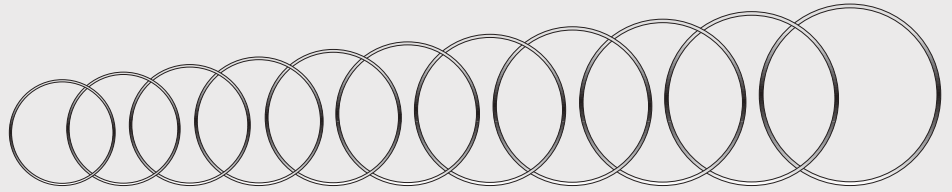

<b>H-3234/1</b>	14 mm	<b>H-3234/4</b>	17 mm	<b>H-3234/7</b>	20 mm	<b>H-3234/10</b>	23 mm	$\frac{1}{1}$
<b>H-3234/2</b>	15 mm	<b>H-3234/5</b>	18 mm	<b>H-3234/8</b>	21 mm	<b>H-3234/11</b>	24 mm	
<b>H-3234/3</b>	16 mm	<b>H-3234/6</b>	19 mm	<b>H-3234/9</b>	22 mm			

**Fine-Thornton**  
Fixierring  
Fixation ring  
Anillo de fijación  
Anneau de fixation



<b>H-2595/1</b>	13 mm	<b>H-2595/2</b>	16 mm
-----------------	-------	-----------------	-------

**H-2596 Thornton**  
Fixierring, 16 mm, geschlossen  
Fixation ring, 16 mm, closed  
Anillo de fijación, 16 mm, cerrado  
Anneau de fixation, 16 mm, fermé



**H-2597 Hofmann-Thornton**  
Fixierring, 16 mm, geschlossen  
Fixation ring, 16 mm, closed  
Anillo de fijación, 16 mm, cerrado  
Anneau de fixation, 16 mm, fermé



**H-2598 Gimbel**  
LASIK Fixationsring, 13 mm  
LASIK stabilization ring, 13 mm  
Anillo de fijación de LASIK, 13 mm  
Anneau de fixation LASIK, 13 mm



**H-2599** Fixierring mit konzentrischen Riefen  
Fixation ring with concentric grooves  
Anillo de fijación con estrías concéntricas  
Anneau de fixation avec rainure concentrique



**H-2607 Lu-Mendez**  
Mess- & Fixierring, i.D. 11 mm  
Degree gauge and fixation ring, i.d. 11 mm  
Instrumento de medición en grado y anillo de fijación, diámetro interior 11 mm  
Anneau de fixation, diamètre intérieur 11 mm



H-7200

**Krumeich**

Saugring zur Fixierung des Auges  
 Außendurchmesser: 18 mm  
 Innendurchmesser: 11 mm  
 Markierungen bei 0°, 90°, 180° und 270°

Vacuum fixation ring  
 Outer diameter: 18 mm  
 Inner diameter: 11 mm  
 Marking on 0°, 90°, 180° and 270°

Anillo de succión para fijación del ojo  
 Diámetro exterior: 18 mm  
 Diámetro interior: 11 mm  
 Marcación en 0°, 90°, 180° y 270°

Anneau de succion pour fixer de l'œil  
 Diamètre extérieur: 18 mm  
 Diamètre intérieur: 11 mm  
 Marquage en 0°, 90°, 180° et 270°



**Der LASIK Saugring verhindert die Entstehung von Aberrationen**

Die Entstehung von Aberrationen höherer Ordnung (HOA) scheint ein häufig vorkommendes und nicht vom Chirurgen vermeidbares, unerwünschtes Ergebnis zu sein. Die Induktion solcher, vorher nicht erkennbarer HOAs ist nicht davon abhängig, ob ein mechanisches Mikrokeratom oder der Femto-Laser für den Flapschnitt verwendet wurde. Sie entstehen sowohl bei Excimer Laser mit 200 Hz als auch bei den neuesten Modellen von 500-700 Hz.

HOAs entstehen immer bei Sakkaden oder auch nur bei plötzlichen und spontanen, schnellen Augenbewegungen. Diese Bewegungen sollten vom Tracker kompensiert werden. Wie jedoch Dr. Krumeich nach verschiedenen Tests festgestellt hat, ist die einzige Möglichkeit HOAs zuverlässig zu vermeiden, die mechanische Fixierung des Auges.

Durch die Fixierung mit dem Krumeich Saugring wird der intraokulare Druck nicht erhöht. Insoweit wird auch die Blutzufuhr nicht gestoppt und keine venöse Stauung verursacht. Jeder Ring, der nach dem Barraquer-Prinzip aufgebaut ist, erhöht den intraokularen Druck auf ca. 60 mm Hg und stoppt die Blutzufuhr. Solche Ringe dürfen also nicht verwendet werden.

Der Krumeich Saugring ist mit einem Innendurchmesser von 11 mm so dimensioniert, dass er den Ablauf des Lasers nicht stört. Der Ring wird mit 400-600 mm Hg nach der Flapentstehung aufgesetzt und während der Excimer-Behandlung per Hand fixiert.

**LASIK-Suction-Ring to avoid aberrations**

The appearance of higher-order (HOA) aberrations seems to be a common and not avoidable and unwanted result during LASIK procedures. The induction of such, not previously detectable HOAs, does not depend on whether a mechanical microkeratome or femto-laser was used to cut the flap. It accrues by using excimer-lasers with 200 Hz, as well as with the latest models of 500-700 Hz.

HOAs appear when saccades of spontaneous rapid eye movements are reported during the operation. These movements should be compensated by the tracker, but according to several tests of Dr. Krumeich, the only reliable method to avoid HOAs is a mechanical fixation of the eye. The fixation with the Krumeich suction ring does not increase the intraocular pressure. In this respect, also the blood supply is not stopped or a venous stasis is not caused.

A fixation ring which is built according to the principle of the Barraquer increases intraocular pressure to approximately 60 mm hg and stops the blood flow for the time of the intake. Such a ring is not suitable for fixation.

The Krumeich suction ring has a inner diameter of 11 mm, so that it doesn't bother the trace of the laser. The ring is placed after creating the flap and manually fixed with vacuum of 400-600 mbar.





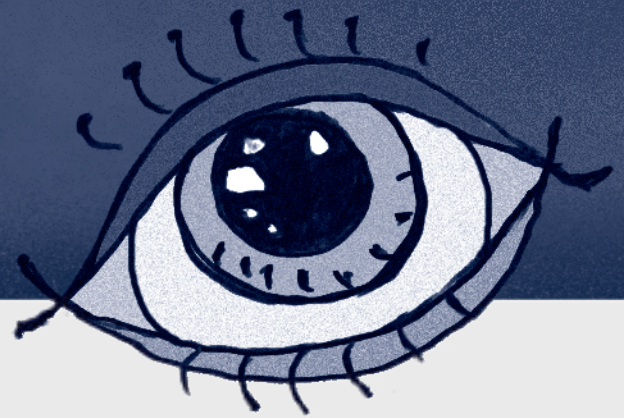
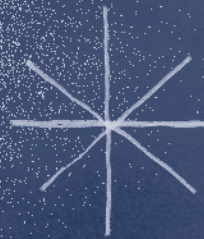
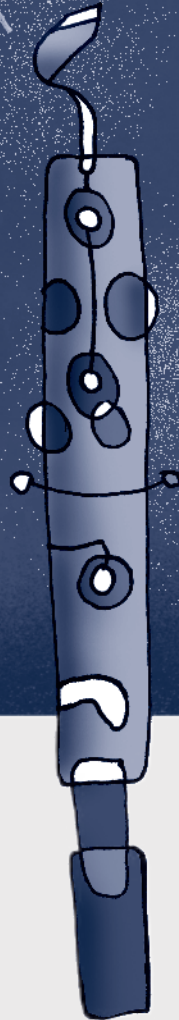
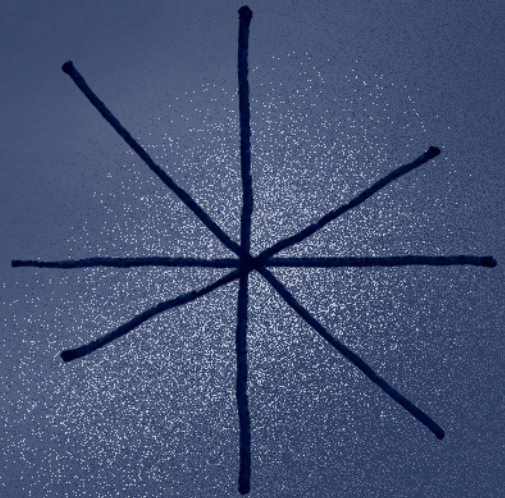
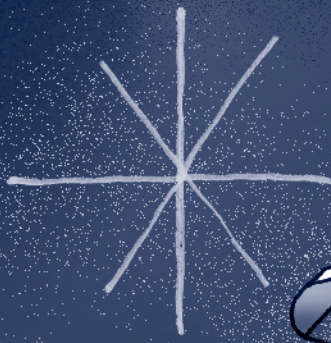

# 2

- ..... Scharfe Instrumente
- ..... Sharp Instruments
- ..... Instrumentos Cortantes
- ..... Instruments Tranchants
- .....



1/1

Diamantmesser für die Kataraktchirurgie, Titangriff mit Bajonett-Verschluss  
Diamond knife, titanium handle, bajonet lock

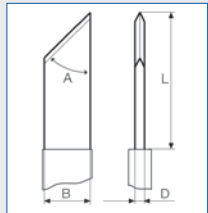

H-1390/1

B	L	D	A
1.0 mm	3.0 mm	0.17 mm	45°

H-1390/2

1.0 mm	2.0 mm	0.17 mm	30°
--------	--------	---------	-----

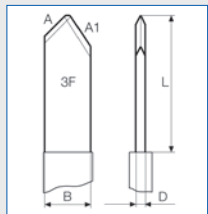

H-1390/3

1.0 mm	3.0 mm	0.17 mm	45°/30° Tri-facet
--------	--------	---------	-------------------

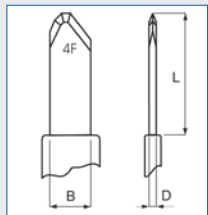

H-1390/4

1.0 mm	3.0 mm	0.17 mm	bogenförmig mit 4 Facetten curved with 4 facets
--------	--------	---------	--



1/1

Speer mit stumpfen Seiten  
Spear with blunt sides

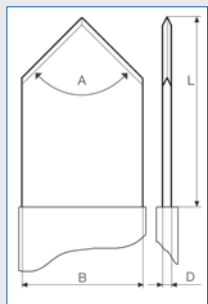

H-1391/1

B	L	D	A
2.8 mm	4.0 mm	0.17 mm	90°

H-1391/2

3.0 mm	4.0 mm	0.17 mm	90°
--------	--------	---------	-----

H-1391/3

3.2 mm	4.0 mm	0.17 mm	90°
--------	--------	---------	-----

B = Breite  
width  
anchura  
largeur

L = Länge  
length  
longitud  
longueur

D = Dicke  
height  
grosor  
épaisseur

A = Klingenwinkel / Klingenform  
blade angle / shape  
angular / forma  
angle / forme





A.HEISS

1/1

Speer mit stumpfen Seiten  
Spear with blunt sides

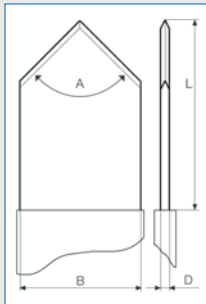

	B	L	D	A
H-1380/03	1.0 mm	3.0 mm	0.17 mm	90°
H-1380/02	1.4 mm	4.0 mm	0.17 mm	90°
H-1380/01	2.2 mm	4.0 mm	0.17 mm	90°
H-1380/0	2.5 mm	4.0 mm	0.17 mm	90°

Lanze mit stumpfen Seiten  
Lance with blunt sides

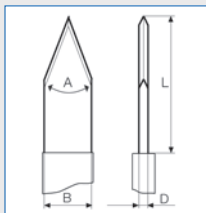

	B	L	D	A
H-1380/1	1.0 mm	3.0 mm	0.17 mm	40°
H-1380/2	1.0 mm	3.0 mm	0.17 mm	60°



A.HEISS

1/1

Tunnelmesser mit 19 Facetten  
Tunnel knife with 19 facets

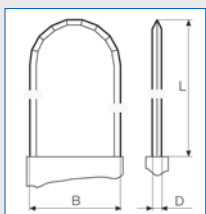

	B	L	D
H-1391/4	1.4 mm	4.0 mm	0.17 mm
H-1391/5	2.0 mm	4.0 mm	0.17 mm

B = Breite  
width  
anchura  
largeur

L = Länge  
length  
longitud  
longueur

D = Dicke  
height  
grosor  
épaisseur

A = Klingenwinkel / Klingenform  
blade angle / shape  
angular / forma  
angle / forme



1/1

Clear Cornea mit schneidenden Seiten  
Clear Cornea with sharp sides

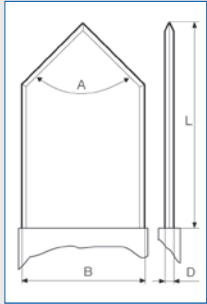

	B	L	D	A
H-1395/12	3.0 mm	4.0 mm	0.17 mm	60°
H-1395/1	2.5 mm	4.0 mm	0.17 mm	90°
H-1395/2	2.8 mm	4.0 mm	0.17 mm	90°
H-1395/3	3.0 mm	4.0 mm	0.17 mm	90°
H-1395/4	3.2 mm	4.0 mm	0.17 mm	90°



1/1

MICS Speer Trapezoid mit schneidenden Seiten – für Mikroschnitte  
Tapered spear MICS for micro coaxial surgery

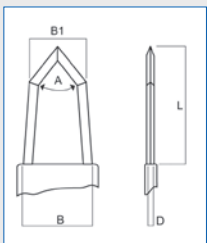

	B	L	D	A
H-1395/8	1.8 – 2.4 mm	4.0 mm	0.17 mm	90°
H-1395/9	1.8 – 2.2 mm	4.0 mm	0.17 mm	90°
H-1395/10	1.5 – 1.8 mm	4.0 mm	0.17 mm	90°
H-1395/11	1.1 – 1.4 mm	4.0 mm	0.17 mm	90°

B = Breite  
width  
anchura  
largeur

L = Länge  
length  
longitud  
longueur

D = Dicke  
height  
grosor  
épaisseur

A = Klingenwinkel / Klingenform  
blade angle / shape  
angular / forma  
angle / forme



MICS Clear Cornea mit schneidenden Seiten  
MICS Clear Cornea with sharp sides

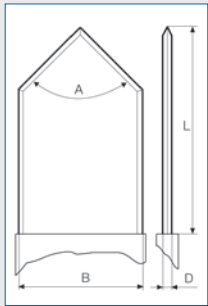

	B	L	D	A
<b>H-1398/1</b>	1.0 mm	4.0 mm	0.17 mm	90°
<b>H-1398/2</b>	1.6 mm	4.0 mm	0.17 mm	90°
<b>H-1398/3</b>	1.8 mm	4.0 mm	0.17 mm	90°
<b>H-1398/4</b>	2.0 mm	4.0 mm	0.17 mm	90°
<b>H-1398/5</b>	2.2 mm	4.0 mm	0.17 mm	90°

Speer Trapezoid mit 4 Facetten  
tapered spear with 4 facets

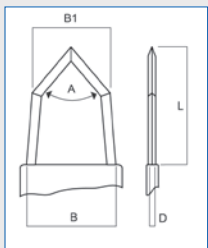

	B	L	D	A
<b>H-1395/5</b>	2.75 – 3.2 mm	4.0 mm	0.17 mm	90°
<b>H-1395/6</b>	2.5 – 3.0 mm	4.0 mm	0.17 mm	90°

Speer Trapezoid mit 6 Facetten  
Tapered spear with 6 facets

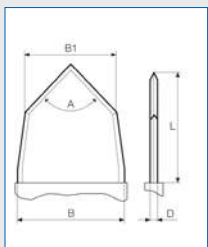

	B	L	D	A
<b>H-1395/7</b>	2.65 – 3.2 mm	4.0 mm	0.17 mm	90°

B = Breite  
width  
anchura  
largeur

L = Länge  
length  
longitud  
longueur

D = Dicke  
height  
grosor  
épaisseur

A = Klingenwinkel / Klingensform  
blade angle / shape  
angular / forma  
angle / forme

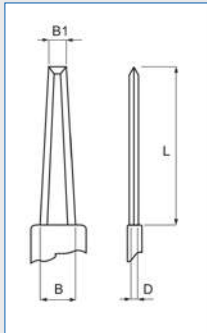

1/1

Zaldivar Universalmesser  
Zaldivar multi purpose knife

	B	B1	L	D
H-1396/1	1.0 mm	0.55 mm	4.5 mm	0.17 mm

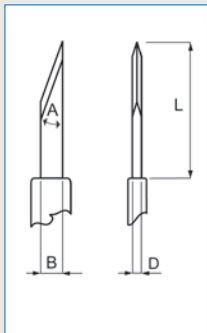

1/1

Spezialmesser für die Viskokanalostomie

	B	L	D	A
H-1396/2	0.5 mm	3.5 mm	0.2 mm	20°

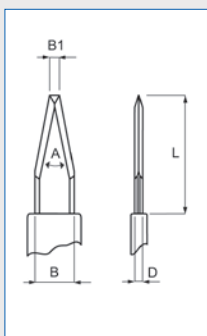

1/1

Stufenmesser, 7 Stufen 0.15 / 0.2 / 0.25 / 0.3 / 0.37 / 0.5 / 4.0 mm  
Step knife, 7 steps 0.15 / 0.2 / 0.25 / 0.3 / 0.37 / 0.5 / 4.0 mm

	B	B1	L	D	A
H-1396/3	1.0 mm	0.3 mm	3.5 mm	0.17 mm	25°

B = Breite  
width  
anchura  
largeur

L = Länge  
length  
longitud  
longueur

D = Dicke  
height  
grosor  
épaisseur

A = Klingenwinkel / Klingensform  
blade angle / shape  
angular / forma  
angle / forme



1/1

Glaukoma, 7 Stufen: 0.15 / 0.2 / 0.25 / 0.3 / 0.37 / 0.5 / 4.0 mm  
 Glaucomar, 7 steps: 0.15 / 0.2 / 0.25 / 0.3 / 0.37 / 0.5 / 4.0 mm  
 Glaucomar, 7 profundidades: 0.15 / 0.2 / 0.25 / 0.3 / 0.37 / 0.5 / 4.0 mm  
 Glaucomar, 7 profondeurs: 0.15 / 0.2 / 0.25 / 0.3 / 0.37 / 0.5 / 4.0 mm

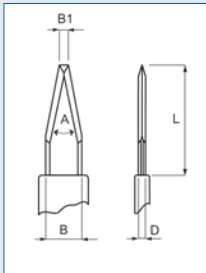

	B	B1	L	D	A / A1
<b>H-1394/4</b>	1.0 mm	0.3 mm	3.5 mm	0.17 mm	25°



1/1

3D Diamantmesser mit schneidenden Seiten  
 Diamond knife, 3D-blade with sharp sides

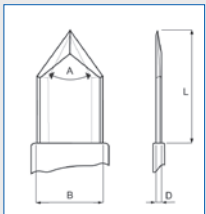

	B	L	D	A
<b>H-1397/1</b>	1.6 mm	4.0 mm	0.17 mm	80°
<b>H-1397/2</b>	1.8 mm	4.0 mm	0.17 mm	80°
<b>H-1397/3</b>	2.2 mm	4.0 mm	0.17 mm	80°
<b>H-1397/4</b>	2.5 mm	4.0 mm	0.17 mm	80°
<b>H-1397/5</b>	2.8 mm	4.0 mm	0.17 mm	80°
<b>H-1397/6</b>	3.0 mm	4.0 mm	0.17 mm	80°
<b>H-1397/7</b>	3.2 mm	4.0 mm	0.17 mm	80°



1/1

Diamantmesser für Hornhautinzisionen, 0.50 mm Schnitttiefe  
 Diamond knife, limbal relaxing incision, cutting depth 0.50 mm

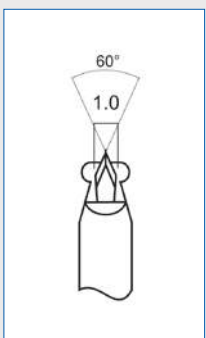

	B	D	A
<b>H-1381</b>	0.5 mm	0.2 mm	20°

B = Breite  
width  
anchura  
largeur

L = Länge  
length  
longitud  
longueur

D = Dicke  
height  
grosor  
épaisseur

A = Klingenwinkel / Klingensform  
blade angle / shape  
angular / forma  
angle / forme



Diamantmesser für Hornhautinzissionen,  
0.50 / 0.55 / 0.60 mm Schnitttiefe

1/1

Diamond knife, limbal relaxing incision,  
cutting depths 0.50 / 0.55 / 0.60 mm

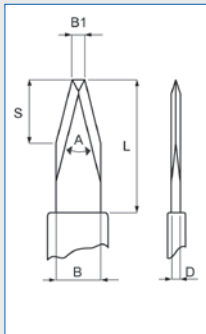

H-1382/1

B	B1	L	D	A
1.0 mm	0.4 mm	3.0 mm	0.1 mm	20°



Diamantmesser für Hornhautinzissionen, Schnitttiefe 0.60 mm  
Diamond knife, limbal relaxing incision, cutting depth 0.60 mm

1/1

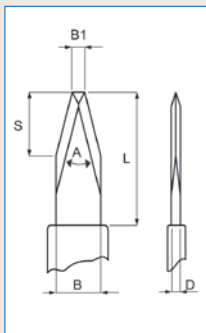

H-1382/2

B	B1	L	D	A
1.0 mm	0.4 mm	3.0 mm	0.1 mm	20°

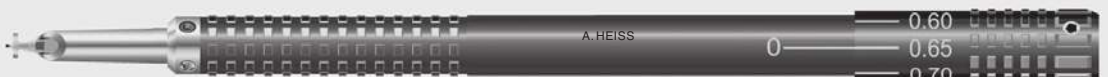

Diamantmesser für Hornhautinzissionen,  
0.45 / 0.50 / 0.55 / 0.60 / 0.65 / 0.70 / 0.75 mm Schnitttiefe

1/1

Diamond knife, limbal relaxing incision,  
cutting depth 0.45 / 0.50 / 0.55 / 0.60 / 0.65 / 0.70 / 0.75 mm

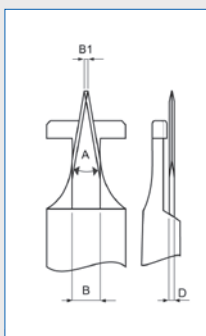

H-1382/3

B	B1	D	A
0.8 mm	0.2 mm	0.1 mm	15°

B = Breite  
width  
anchura  
largeur

L = Länge  
length  
longitud  
longueur

D = Dicke  
height  
grosor  
épaisseur

A = Klingenwinkel / Klingenform  
blade angle / shape  
angular / forma  
angle / forme



1/1

Diamantmesser mit Mikrometer für die refraktive Chirurgie  
Diamond knife with a micrometer for refractive surgery

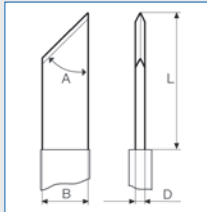

	B	L	D	A
<b>H-1393/1</b>	1.0 mm	3.0 mm	0.17 mm	45°

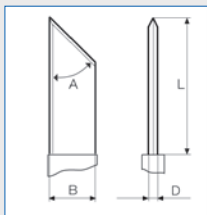

Klinge mit 2 Schneiden vertikal  
Blade double edge vertical

<b>H-1393/2</b>	1.0 mm	3.0 mm	0.17 mm	45°
-----------------	--------	--------	---------	-----

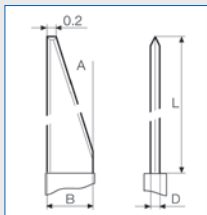

Klinge mit 3 Schneiden vertikal für gerade Astigmatismus-Inzisionen  
Blade with triple edge vertical for straight astigmatism incisions

<b>H-1393/3</b>	1.0 mm	3.0 mm	0.1 mm	15°
-----------------	--------	--------	--------	-----

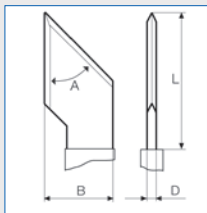

Klinge mit 3 Schneiden für Schnitte vom Limbus zur optischen Zone  
Blade with triple edge for cuts from limbus to the optical zone

<b>H-1393/4</b>	1.5 mm	3.0 mm	0.17 mm	45°
-----------------	--------	--------	---------	-----

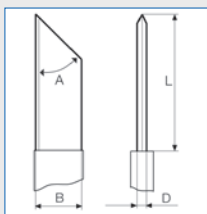

Klinge mit 1 Schneide vertikal  
Blade with one edge vertical

<b>H-1393/5</b>	1.0 mm	3.0 mm	0.17 mm	45°
-----------------	--------	--------	---------	-----

B = Breite  
width  
anchura  
largeur

L = Länge  
length  
longitud  
longueur

D = Dicke  
height  
grosor  
épaisseur

A = Klingenwinkel / Klingenform  
blade angle / shape  
angular / forma  
angle / forme





Diamantmesser mit 7 Stufen:  
0 / 0.3 / 0.4 / 0.5 / 0.6 / 0.8 / 1.0 / 2.5 mm  
Diamond knife with 7 steps:  
0 / 0.3 / 0.4 / 0.5 / 0.6 / 0.8 / 1.0 / 2.5 mm

1/1

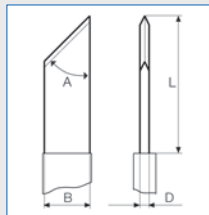

	B	L	D	A / A1
<b>H-1394/1</b>	1.0 mm	3.0 mm	0.17 mm	45°

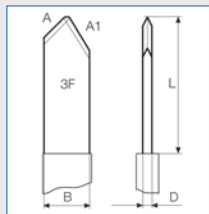

<b>H-1394/2</b>	0.9 mm	3.0 mm	0.17 mm	45° / 30°
				Tri-facet Klinge Tri-facet blade

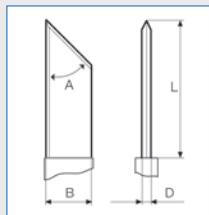

<b>H-1394/3</b>	1.0 mm	3.0 mm	0.17 mm	45°
				2 Schneiden vertikal Double edge vertical

B = Breite  
width  
anchura  
largeur

L = Länge  
length  
longitud  
longueur

D = Dicke  
height  
grosor  
épaisseur

A = Klingenwinkel / Klingenform  
blade angle / shape  
angular / forma  
angle / forme



Diamantmesser für die Retina-Chirurgie, Titangriff, gerade  
Retina diamond knife, titanium handle, straight

1/1

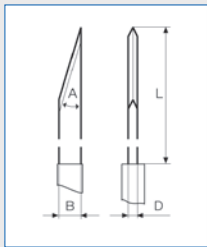

	B	L	D	A
<b>H-1383/1</b>	0.5 mm	3.0 mm	0.17 mm	20°
<b>H-1383/2</b>	0.9 mm	3.0 mm	0.17 mm	45°
<b>H-1383/3</b>	1.0 mm	3.0 mm	0.17 mm	45°

B = Breite  
width  
anchura  
largeur

L = Länge  
length  
longitud  
longueur

D = Dicke  
height  
grosor  
épaisseur

A = Klingenwinkel / Klingenform  
blade angle / shape  
angular / forma  
angle / forme

Augenskalpell, geballt  
 Eye scalpel, bellied  
 Bisturi hoja, convexa  
 Bistouri, convexe

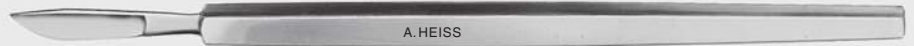

1/1

H-1200/1 Fig. 1



H-1200/2 Fig. 2



H-1212 Chalazionsmesser, fein  
 Chalazion knife, delicate  
 Bisturi de chalazi3n, delicado  
 Bistouri 3 chalazion, fin

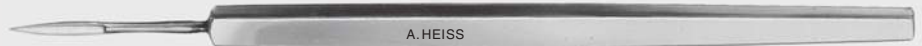

1/1

**Graefe**

Skarifikateur  
Scarifier  
Escarificador  
Scarificateur pour le sac lacrymal

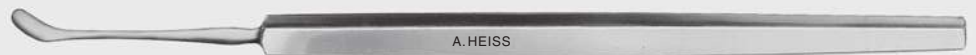

1/1

H-1235/1 Fig. 1



1/1

H-1235/2 Fig. 2



1/1

H-1235/3 Fig. 3



1/1

H-1250

Pterygiummesser  
Pterygium knife  
Cuchillo para pterigi3n  
Couteau pour pt3rygion

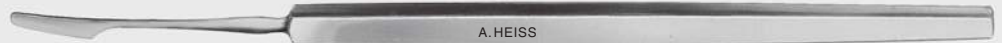

A. HEISS

1/1

**Graefe**

Starmesser  
Cataract knife  
Cuchillo para cataratas  
Couteau 3 cataracte

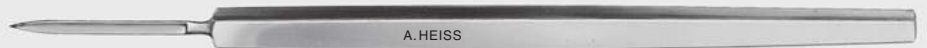

A. HEISS

1/1

H-1300/1 Fig. 1



1/1

H-1300/2 Fig. 2



1/1

H-1360

**Wheeler**

Diszissionsmesser  
Discission knife  
Cuchillo para discisi3n  
Couteau 3 dissection

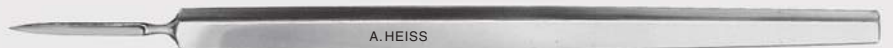

A. HEISS

1/1

**Ziegler**

Diszissionsmesser  
 Discission knife  
 Cuchillo para discisión  
 Couteau pour l'iris



1/1

H-1500/1 Fig. 1



1/1

H-1500/2 Fig. 2



1/1

H-1500/3 Fig. 3



1/1

**H-1530 Barkan**

Goniotomiemesser  
 Goniotomy knife  
 Cuchillo para goniotomia  
 Couteau pour goniotomie

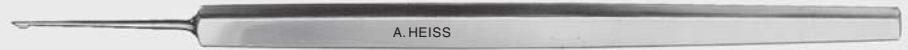

1/1

**H-1535 Sato**

Hornhautmesser, gerade  
 Corneal knife, straight  
 Queratótomo, recto  
 Couteau pour la cornée, droit

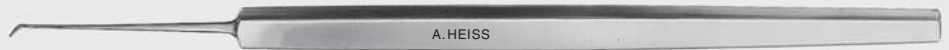

1/1



**H-1600** **Tooke**  
Hornhautmesser  
Corneal knife  
Queratómo  
Couteau pour la cornée



1/1

**H-1602** **Johnson-Tooke**  
Hornhautmesser  
Corneal knife  
Queratómo  
Couteau pour la cornée



1/1

**H-1605** **Gill**  
Hornhautmesser  
Corneal knife  
Queratómo  
Couteau pour la cornée



1/1

**H-1610** **Paton**  
Hornhautdissektor  
Corneal dissector  
Disecador para la córnea  
Dissecteur pour la cornée



1/1

**Kuhnt**  
Hornhautschaber  
Corneal scarifier  
Legra para la córnea  
Rugine pour la cornée



1/1

**H-1615/1** Fig. 1



1/1

**H-1615/2** Fig. 2



1/1

**H-1615/3** Fig. 3



1/1

**H-1615/4** Fig. 4



1/1

**H-1650** Starnadel, gerade  
Cataract needle, straight  
Aguja para catarata, recta  
Aiguille à cataracte, droite



1/1

**H-1670**    **Bowman**  
 Diszissionsnadel, gerade  
 Discission needle, straight  
 Aguja para discisión, recta  
 Aiguille à dissection, droite



1/1

**H-1700**    Fremdkörpernadel, gerade  
 Foreign-body needle, straight  
 Aguja para cuerpos extraños, recta  
 Aiguille à corps étrangers, droite

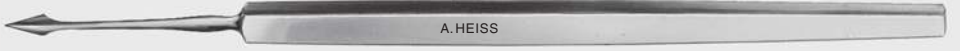

1/1

**H-1702**    Fremdkörpernadel, gebogen  
 Foreign-body needle, curved  
 Aguja para cuerpos extraños, curva  
 Aiguille à corps étrangers, courbe

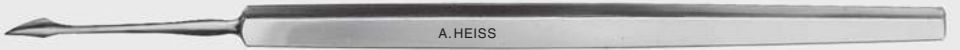

1/1

**H-1704**    **Levinson**  
 Fremdkörpernadel  
 Foreign-body needle  
 Aguja para cuerpos extraños  
 Aiguille à corps étrangers



1/1

**H-1715**    Fremdkörpernadel,  
 Schweizer Modell  
 Foreign-body needle, Swiss model  
 Aguja para cuerpos extraños, modelo suizo  
 Aiguille à corps étrangers, modèle suisse

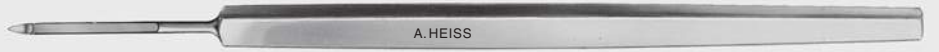

1/1

**H-1730**    **Walton**  
 Hohlmeissel für Fremdkörper  
 Foreign-body gouge  
 Gubia para cuerpos extraños  
 Gouge à corps étrangers

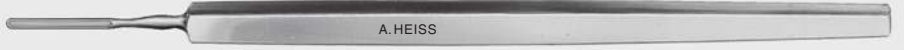

1/1



**H-1740**

**Plange**

Fremdkörpernadel,  
 Foreign-body needle  
 Aguja para cuerpos extraños  
 Aiguille à corps étrangers

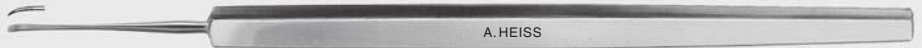

1/1

**H-1742**

**La Force**

Fremdkörperinstrument  
 Foreign-body spud  
 Instrumento para cuerpos extraños  
 Aiguille à corps étrangers

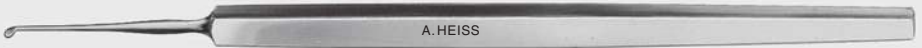

1/1

**H-1743**

**Golf Club**

Fremdkörpernadel, runde Spitze  
 Foreign-body spud, round tip  
 Aguja para cuerpos extraños  
 Aiguille à corps étrangers, bout arrondi

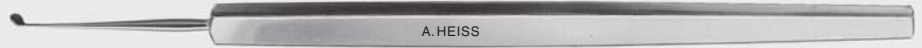

1/1

**H-1744**

**Francis**

Fremdkörperinstrument  
 Foreign-body spud  
 Instrumento para cuerpos extraños  
 Aiguille à corps étrangers

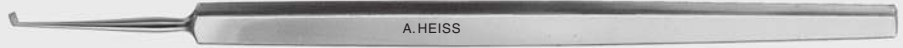

1/1

**H-1745**

**Corbett**

Fremdkörpernadel  
 Foreign-body needle  
 Aguja para cuerpos extraños  
 Aiguille à corps étrangers

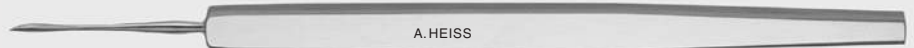

1/1

**H-1752**

Nadel und Hohlmeißel, zum Schieben, runde Hülse  
 Needle and gouge, in round metal sliding handle  
 Aguja y gubia con mango redondo corredizo de metal  
 Aiguille et gouge à manche métal rond à glissière



1/1

H-1753

Nadel und Plangehebel, zum Schieben, runde Hülse  
Needle and foreign-body needle, with round metal sliding handle  
Aguja y aguja para cuerpos extraños con mango redondo corredizo de metal  
Aiguille et aiguille à corps étrangers à manche métal rond à glissière

1/1



H-1760

Nadel und Hohlmeißel, zum Schieben, flache Hülse  
Needle and gouge, with flat metal sliding handle  
Aguja y aguja con mango plano corredizo de metal  
Aiguille et gouge à manche métal plat à glissière

1/1



H-1770

Nadel und scharfer Löffel, zum Schieben, runde Hülse  
Needle and curette, with round metal sliding handle  
Aguja y cucharilla cortante con mango plano corredizo de metal  
Aiguille et curette tranchante à manche métal rond à glissière

1/1



H-1780

Nadel und Hohlmeißel in Umsteckhülse  
Needle and gouge in reversible handle  
Aguja y gubia reversible, con rosca  
Aiguille et gouge, se dévissant,  
rentrant dans le manche

1/1

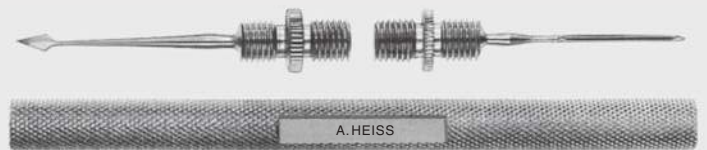

### Hebra

Chalazionslöffel  
Chalazion curette  
Cucharilla para chalazion  
Curette á chalazion, tranchante

1/1

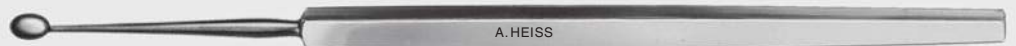

H-2120/1

Fig. 1



1/1

H-2120/2

Fig. 2



1/1

H-2120/3

Fig. 3



1/1

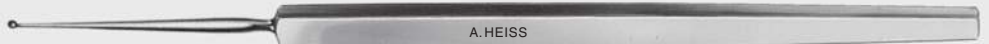

**Meyhoefer**

Chalazionslöffel, scharf  
Chalazion curette, sharp  
Cucharilla para chalazion, cortante  
Curette á chalazion tranchante

1/1

H-2140 1.0 mm



1/1

H-2140/0 0.5 mm



1/1

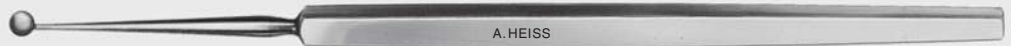

**Meyhoefer**

Chalazionslöffel, scharf  
Chalazion curette, sharp  
Cucharilla para chalazion, cortante  
Curette á chalazion tranchante

1/1

H-2150/00 Fig. 00  
1.5 mm



1/1

H-2150/0 Fig. 0  
2.0 mm



1/1

H-2150/1 Fig. 1  
2.5 mm



1/1

H-2150/2 Fig. 2  
3.0 mm



1/1

H-2150/3 Fig. 3  
3.5 mm



1/1

H-2150/4 Fig. 4  
4.0 mm



1/1



H-2180

**Axenfeld**

Chalazions-Doppellöffel, scharf  
Chalazion curette, double, sharp  
Cucharilla para chalazion, doble, cortante  
Curette á chalazion, tranchante, double

1/1

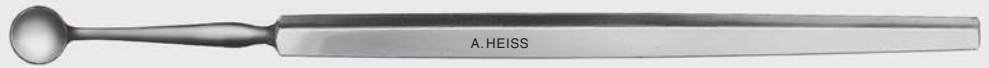

**Bunge**  
 Excenterationslöffel, scharf  
 Evisceration spoon, sharp  
 Cucharilla para evisceración, cortante  
 Curette pour éviscération

1/1

H-2165/1 Fig. 1  
 6 mm



1/1

H-2165/2 Fig. 2  
 7 mm



1/1

H-2165/3 Fig. 3  
 8,5 mm



1/1

H-2165/4 Fig. 4  
 10 mm



1/1

**H-2080 Graefe**  
 Starlöffel  
 Lens spoon  
 Cucharilla para catarata  
 Curette á cataracte

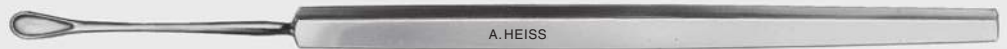

A. HEISS

1/1

**Daviel**  
 Starlöffel  
 Lens spoon  
 Cucharilla para catarata  
 Curette pour cataracte

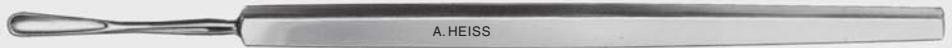

A. HEISS

1/1

H-2085/1 Fig. 1



1/1

H-2085/2 Fig. 2



1/1

H-2580



**Barraquer**

Keratoplastikmesser,  
birnenförmig

Keratoplasty knife,  
pear-shaped

Cuchillo para queratoplastia,  
forma pera

Couteau pour kératoplastie,  
en poire

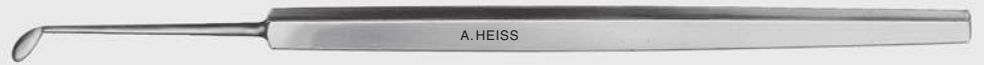

1/1

H-2582

**Barraquer**

Keratoplastikmesser,  
7 × 1.0 mm

Keratoplasty knife,  
7 × 1.0 mm

Cuchillo para queratoplastia,  
7 × 1.0 mm

Couteau pour kératoplastie,  
7 × 1.0 mm

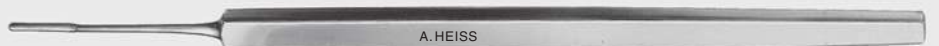

1/1

H-2584

**Paufique**

Keratoplastikmesser

Keratoplasty knife

Cuchillo para queratoplastia

Couteau pour kératoplastie



1/1

**Castroviejo**

Hornhauttrephine

Corneal trephine

Trépano para la córnea

Trepan corneén



1/1

H-2550/1 5.0 mm

H-2550/2 5.5 mm

H-2550/3 6.0 mm

H-2550/4 6.5 mm

H-2550/5 7.0 mm

H-2550/6 7.5 mm

H-2550/7 8.0 mm

H-2550/8 8.5 mm

H-2550/9 9.0 mm

H-2550/10 9.5 mm

H-2550/11 10.0 mm

H-2550/12 11.0 mm

Hornhauttrephine  
 Corneal trephine  
 Trépano para la córnea  
 Trépan cornéen



1/1

zu verwenden mit  
 to be used with  
 para usar con  
 adaptée à

Trephinengriff  
 Trephine handle  
 Mango para trépano  
 Poignée de trépan



1/1

H-2560/002	3.0 mm	—	
H-2560/001	3.25 mm	—	
H-2560/09	3.5 mm	—	
H-2560/08	3.75 mm	—	
H-2560/07	4.0 mm	—	
H-2560/06	4.25 mm	—	
H-2560/05	4.5 mm	—	
H-2560/04	4.75 mm	—	
H-2560/03	5.0 mm	—	
H-2560/02	5.25 mm	—	
H-2560/01	5.5 mm	—	
H-2560/0	5.75 mm	—	
H-2560/1	6.0 mm	H-2561/1	6.0 mm
H-2560/2	6.25 mm	H-2561/2	6.25 mm
H-2560/3	6.5 mm	H-2561/3	6.5 mm
H-2560/4	6.75 mm	H-2561/4	6.75 mm
H-2560/5	7.0 mm	H-2561/5	7.0 mm
H-2560/6	7.25 mm	H-2561/6	7.25 mm
H-2560/7	7.5 mm	H-2561/7	7.5 mm
H-2560/8	7.75 mm	H-2561/8	7.75 mm
H-2560/9	8.0 mm	H-2561/9	8.0 mm
H-2560/10	8.25 mm	H-2561/10	8.25 mm
H-2560/11	8.5 mm	H-2561/11	8.5 mm
H-2560/12	8.75 mm	H-2561/12	8.75 mm
H-2560/13	9.0 mm	H-2561/13	9.0 mm
H-2560/14	9.25 mm	H-2561/14	9.25 mm

H-2562

Universal-Trephinengriff für H-2560/1 – H2560/9  
Trepine handle for H-2560/1 – H2560/9  
Mango para trépano para H-2560/1 – H2560/9  
Poignée de trépan universel adaptée à la tête de trépan pour H-2560/1 – H2560/9



1/1

H-1280

Skalpellgriff Nr. 3  
Scalpel handle No. 3  
Mango de bisturí No. 3  
Manches pour bistouris No. 3



1/1

H-1281

Skalpellgriff Nr. 7  
Scalpel handle No. 7  
Mango de bisturí No. 7  
Manches pour bistouris No. 7



1/1

H-1290

Skalpellgriff, Mikro-Skalpellklingen  
Scalpel handle, micro scalpel blades  
Mango de bisturí, micro hojas de bisturí  
Manches pour bistouris, micro lame de bistouris



1/1

H-1290A

Skalpellgriff, 13 cm, für Mikro-Skalpellklingen  
Blade handle, 13 cm, for micro scalpel blades  
Porta hojas, 13, para micro hojas de bisturí  
Manches pour bistouris, 13 cm, pour micro lame de bistouris



1/1



**Entwickelt von**  
**Developed by**  
Jörg H. Krumeich M.D.  
Bochum, Germany



### Trepan System der modernsten Art

- Innovative Technik für die
- Perforierende Keratoplastik
  - Tiefe lamelläre Keratoplastik
  - Cirkuläre Keratotomie
  - Astigmatismus Chirurgie

### Vorteile des geführten Trepan Systems

- Identische Dimensionen beim Spender und Empfänger
- Schnitt der Spenderhornhaut erfolgt unter demselben Druck wie beim Empfänger
- Identische Schnittkanten an der Spenderhornhaut und beim Empfänger
- Kein Verkippen des Trepan während des Schnitts, die wesentliche Ursache für Astigmatismus
- Glasobturator für Spender und Empfänger, damit der Schnitt gegen eine fixierte Spähre durchgeführt wird, die den jeweiligen Radien genau entspricht
- Einzigartiger Saugring der den intraokulären Druck nicht erhöht
- Einziges Trepansystem welches einen 360° Schnitt ohne Zuhilfenahme einer Hornhautschere erlaubt
- Gewährleistet immer gleiche Schnittkanten

### State of the Art Trepan System

- The most innovative system for
- Penetrating Keratoplasty
  - Deep Lamellar Keratoplasty
  - Circular Keratotomy
  - Astigmatism Surgery

### Advantages of the Guided Trepan System

- Identical dimensions on both donor and recipient
- Donor and recipient are cut under the same pressure for identical dimensions
- Same undercut on donor bottom and recipient's bed
- No tilt during cut, the main cause of astigmatism
- Glass obturators to allow cutting against a fixed sphere of the radius of respective donor and recipient
- Unique non-IOP elevating suction ring
- Only trephine that cuts 360° without use of scissors
- Maintains same cutting angle

### H-2400 GTS System – Set

komplett, bestehend aus:  
complete, consisting of:

- H-2410 Saugring / Suction ring
- H-2411 Vorderkammerkörper / Anterior chamber (body)
- H-2412 Zentralpilz / Plug
- H-2413 Obere Vorderkammerschraube  
Upper anterior chamber screw
- H-2414 Führungshülse / Outer guide
- H-2415 Trepankern / Core
- H-2406 Fixiererring 11 mm / Fixation plate 11 mm
- H-2407 Fixiererring 12 mm / Fixation plate 12 mm
- H-2408 T-Stück / T-piece
- H-2409 Stößel / Push rod
- H-2420 Trepan 7.5 mm / Trephine 7.5 mm
- H-2421 Trepan 8.0 mm / Trephine 8.0 mm
- H-2405 Trepan 15.0 mm / Trephine 15.0 mm
- H-2449 Instrumentensieb / Instrument tray
- H-2450 Glasobturator Set \* / Glass obturator set \*
- H-3000 Pinzette / Forceps



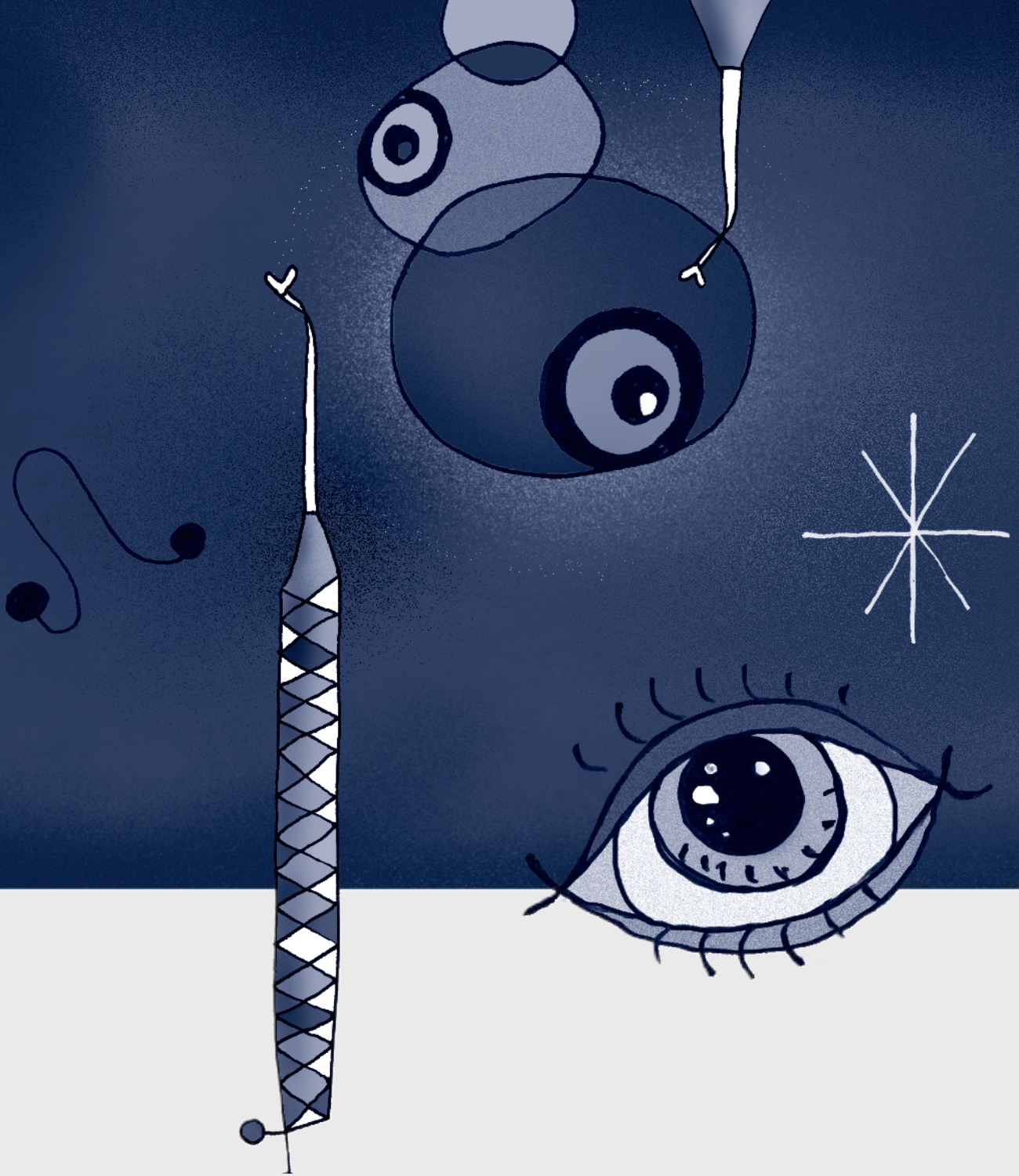

# 3

- Spatel & Manipulatore
- Spatulas & Manipulators
- Espátulas & Manipuladores
- Spatules & Manipulateurs
-

H-1162

**Mawas**

Irisretractor  
Iris retractor  
Retractor para iris  
Retracteur d'iris



**Graether**

Irisretractor mit Kragenknopf  
Iris retractor, collar button  
Retractor para iris, botón en el cuello  
Rétracteur d'iris, "bouton de col"

H-1166A

abgewinkelt  
angled  
angulado  
coudé



H-1166

gerade  
straight  
recto  
droit



**Graefe**

Irishäkchen  
Iris hook  
Gancho para iris  
Crochet pour l'iris

H-1800

scharf  
sharp  
agudo  
pointu



H-1802

stumpf  
blunt  
romo  
mousse



H-1804

Mikro-Irishäkchen, Modell Bonn  
Mikro-iris hook, Bonn model  
Micro-gancho para iris, modelo Bonn  
Micro-crochet pour l'iris, modèle Bonn





**H-1960**      **Culler**  
 Irisspatel, 1 mm  
 Iris spatula, 1 mm  
 Espátula para iris, 1 mm  
 Spatule pour l'iris, 1 mm



1/1

**H-1977**      **Culler**  
 Irisspatel, 1.7 mm  
 Iris spatula, 1.7 mm  
 Espátula para iris, 1.7 mm  
 Spatule pour l'iris, 1.7 mm



1/1

**Wecker**  
 Irisspatel  
 Iris spatula  
 Espátula para iris  
 Spatule pour l'iris

**H-1970/1**      Fig. 1  
 (1.6 mm)



1/1

**H-1970/2**      Fig. 2  
 (2.7 mm)



1/1

**H-1982**      Irisspatel, rund, 0.5 mm  
 Iris spatula, round, 0.5 mm  
 Espátula para iris, redonda, 0.5 mm  
 Spatule pour l'iris, rondé, 0.5 mm



1/1

**H-1992**      **Troutman-Barraquer**  
 Irisspatel  
 Iris spatula  
 Espátula para iris  
 Spatule pour l'iris, manche court



1/1

**Barraquer**  
 Irisspatel, rund  
 Iris spatula, round  
 Espátula para iris, redonda  
 Spatule pour l'iris, rondé

**H-1993/1**      0.50 mm

**H-1993/2**      0.25 mm



1/1



Irisspatel für Vitrektomie & Synechia  
 Iris spatula for vitreous & synechia  
 Espátula para iris, vitre y sinequia  
 Spatule pour l'iris, vitré et synéchie



**H-2095A** Phakospatel 8 mm  
 Phaco spatula, 8 mm  
 Espátula para phaco, 8 mm  
 Spatule pour phaco, 8 mm



**Sinskey**

Linsenhäkchen, 0.2 mm stumpf  
 Lens manipulation hook, 0.2 mm blunt tip  
 Gancho para manapulación de lente, 0.2 mm, romo  
 Crochet manipulateur à implant, 0.2 mm, mousse

**H-1971**



gerade  
 straight  
 recto  
 droit



1/1

**H-1971R**



gerade  
 straight  
 recto  
 droit



1/1

**H-1971A**



abgewinkelt  
 angled  
 angulado  
 coudé



1/1

**H-1971AR**



abgewinkelt  
 angled  
 angulado  
 coudé



1/1

**H-1973**



**Uthoff**

Repositionshäkchen, 0.2 mm  
 Reposition hook, 0.2 mm  
 Gancho de reposición, 0.2 mm  
 Crochet à reposition, 0.2 mm



1/1

**H-1971B**



**Sinskey**

Häkchen, 180° gedreht, abgewinkelt  
 Hook reversed, angled  
 Gancho de reposición, girado por 180°, angulado, roma  
 Crochet, retourné, coudé



1/1



**H-1979**

**Hirschmann**

Linsenmanipulator, abgewinkelt  
 Lens manipulator, angled  
 Manipulador de lentes, angulado  
 Crochet manipulateur, coudé



**H-1975**

**Lewicky**

Linsen Häkchen,  
 abgewinkelt, gebogen  
 0.15 mm stumpf  
 Lens manipulation hook,  
 angled, curved, 0.15 mm blunt tip  
 Gancho para manipulación de lente,  
 angulado, curvo, 0.15 mm, romo  
 Crochet manipulateur à implant,  
 angulé, courbe, 0.15 mm, mousse



**H-1978**

**Harris-Sinskey**

Linsen Häkchen,  
 abgewinkelt, 0.25 mm stumpf  
 Lens manipulation hook,  
 angled, 0.25 mm blunt tip  
 Gancho para manipulación de lente,  
 angulado, 0.25 mm, romo  
 Crochet manipulateur à implant,  
 angulé, 0.25 mm, mousse



**H-1978R**

**Harris-Sinskey**

I.O.L. Häkchen/ Linsen Häkchen,  
 abgewinkelt, 0.25 mm stumpf, Rundgriff  
 Lens manipulation hook,  
 angled, 0.25 mm blunt tip, round handle  
 Gancho para manipulación de lente,  
 angulado, 0.25 mm, romo, mango redondo  
 Crochet manipulateur à implant,  
 angulé, 0.25 mm, mousse, manche ronde



**H-1911**

**Hunkeler**

Linsenkernmanipulator,  
 0.3 mm Halbkugelkopf, abgewinkelt  
 Nucleus manipulator,  
 0.3 mm hemi-ball tip, angled  
 Manipulador para núcleo de lente,  
 0.3 mm cabeza redonda, angulado  
 Crochet manipulateur,  
 0.3 mm embout olivaire, coudé





H-1961



**Jaffe-Bechert**

Linsenkernrotator,  
 abgewinkelt, horizontal

Lens nucleus rotator,  
 angled, horizontal

Rotator para núcleo de lente,  
 angulado, horizontal

Crochet manipulateur de noyau,  
 coudé, mousse, horizontal



1/1

H-1961A



abgewinkelt, vertikal

angled, vertical

angulado, vertical

coudé, vertical

H-1962



**Clayman**

Linsenkernrotator,  
 abgewinkelt,  
 V-förmige Spitze

Lens nucleus rotator,  
 angled, V-shaped tip

Rotator para núcleo,  
 angulado, punta con forma de V

Crochet manipulateur de noyau,  
 coudé, extrémité en V

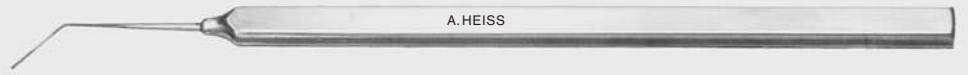

1/1

H-1980



**Pisacano**

Linsenkernrotator, abgewinkelt, vertikal

Nucleus rotator, angled, vertical

Rotator para núcleo de lente, angulado, vertical

Rotateur pour cristallin, coudé, vertical



1/1

H-1980A



**Pisacano**

Linsenkernrotierer, abgewinkelt, horizontal

Lens nucleus rotator, angled, horizontal

Rotator para núcleo de lente, angulado, horizontal

Crochet manipulateur de noyau, coudé, horizontal



1/1

H-1925



**Anis**

Linsenkernmanipulator, 0.5 mm Kugelkopf

Nucleus manipulator, 0.5 mm ball tip

Manipulador para núcleo de lente, 0.5 mm cabeza redondo

Crochet manipulateur, 0.5 mm embout olivaire



1/1

H-1925A



**Anis**

Linsenkernmanipulator, 0.5 mm Kugelkopf, abgewinkelt, gebogen

Nucleus manipulator, 0.5 mm ball tip, angled, curved

Manipulador para núcleo de lente, 0.5 mm cabeza redondo, angulado

Crochet manipulateur, 0.5 mm embout olivaire, coudé



1/1

H-1925B



**Connor Wand**

Linsenkernmanipulator, 0.5 mm Kugelkopf, gebogen

Nucleus manipulator, 0.5 mm ball tip, curved

Manipulador para núcleo de lente, 0.5 mm cabeza redondo, angulado

Crochet manipulateur, 0.5 mm embout olivaire, coudé



1/1

**Lester**

IOL Manipulator  
 IOL manipulator  
 Gancho para manipulación de IOL  
 Crochet manipulateur, coudé olivaire "bouton de col"

**H-1930**



gerade  
 straight  
 recto  
 droit



1/1

**H-1930A**



abgewinkelt  
 angled  
 angulado  
 coudé



1/1

**H-1931**



**Maloney**

IOL Manipulator, gebogen  
 IOL manipulator, curved  
 Gancho para manipulación de IOL, curvo  
 Crochet manipulateur, coudé olivaire "bouton de col", courbe



1/1

**H-1932**



**Lester**

IOL Manipulator, abgewinkelt, gebogen  
 IOL manipulator, angled, curved  
 Gancho para manipulación de IOL, angulado, curvo  
 Crochet manipulateur, Coudé olivaire "bouton de col", coudé, courbe



1/1

**H-1981**



**Drysdale**

Linsenkernelmanipulator  
 Nucleus manipulator  
 Manipulator para núcleo de lente  
 Crochet manipulateur, droit



1/1

**H-1981A**



**Drysdale**

Linsenkernelmanipulator  
 Nucleus manipulator  
 Manipulator para núcleo de lente  
 Crochet manipulateur, droit



1/1

### Kuglen

Irishäkchen und Linsenmanipulator  
 Iris hook and lens manipulator  
 Manipulador de lentes  
 Crochet à l'iris, crochet manipulateur

H-1963



gerade  
 straight  
 recto  
 droit



H-1963A



abgewinkelt  
 angled  
 angulado  
 coudé



H-1964



### Rentsch

„Boat Hook“ Linsenmanipulator, gerade  
 „Boat Hook“ Lens manipulator, straight  
 „Boat Hook“ Manipulador de lentes, recto  
 „Boat Hook“ Spatule pour l'iris, droit



### Frenzl

Linsenmanipulationshäkchen, 0.15 mm  
 Lens manipulating hook, 0.15 mm  
 Gancho para manipulación de lentes, 0.15 mm  
 Crochet manipulateur, 0.15 mm

H-1965



abgewinkelt  
 angled  
 angulado  
 coudé



H-1965A



gerade  
 straight  
 recto  
 droit



H-1966



### Osher

Y-Linsenmanipulator, gerade  
 Y-Hook lens manipulator, straight  
 Gancho para manipulación de lentes, forma Y, recto  
 Crochet manipulateur, droit



H-1966A



### Osher

Linsenkernrotator, abgewinkelt  
 Lens nucleus rotator, angled  
 Rotator para núcleo de lente, angulado  
 Crochet manipulateur de noyau, coudé



H-2315

**Kirby**  
 Linsenschieber  
 Lens expressor  
 Gancho para el cristalino  
 Crochet à cristallin



1/1

H-2350

**Kirby**  
 Linsenschieber, doppelt  
 Lens expressor, double  
 Gancho para el cristalino, doble  
 Crochet à cristallin, double



1/1

H-2355

**Kirby**  
 Linsenschieber und Schlinge  
 Lens expressor hook and loop  
 Expresor y asa  
 Anse et crochet à cristallin



1/1

H-2360

**Kirby**  
 Linsenschieber und Löffel  
 Lens expressor hook and spoon  
 Expresor y cucharilla  
 Curette et crochet à cristallin



1/1

H-1972



**Jaffe**

Linsenspatel, 0.5 mm  
 Lens spatula, 0.5 mm  
 Espátula para el cristalino, 0.5 mm  
 Spatule pour la lentille cristalline, 0.5 mm



1/1

H-1972R



**Jaffe**

Linsenspatel, 0.5 mm  
 Lens spatula, 0.5 mm  
 Espátula para el cristalino, 0.5 mm  
 Spatule pour la lentille cristalline, 0.5 mm



1/1

H-1972A



**Obstbaum**

Linsenspatel, 0.25 mm  
 Lens spatula, 0.25 mm  
 Espátula para el cristalino, 0.25 mm  
 Spatule pour la lentille cristalline, 0.25 mm



1/1

H-1972AR



**Obstbaum**

Linsenspatel, 0.25 mm, Rundgriff  
 Lens spatula, 0.25 mm, round handle  
 Espátula para el cristalino, 0.25 mm, mango redondo  
 Spatule pour la lentille cristalline, 0.25 mm, manche ronde



1/1

H-1974



**Hirschman**

Linsenspatel, 0.5 mm,  
 mit Ausschnitten  
 Lens spatula, 0.5 mm,  
 with notches  
 Espátula para el cristalino,  
 0.5 mm, con ranuras  
 Spatule pour la lentille cristalline,  
 0.5 mm



1/1

H-1986

**Knolle**

Linsenspatel, 0.5 mm  
 Lens spatula, 0.5 mm  
 Espátula para el cristalino, 0.5 mm  
 Spatule pour la lentille cristalline, 0.5 mm



1/1

**Koch**

Linsenspatel,  
 Lens spatula  
 Espátula para el cristalino  
 Spatule pour la lentille cristalline

**H-1987/1**

leicht gebogen  
 gently curved  
 media curva  
 courbe medium



1/1

**H-1987/2**

leicht gebogen,  
 mit Einkerbungen  
 gently curved,  
 with notches  
 media curva,  
 con muesca  
 courbe medium  
 avec échancrure



1/1

**H-2038**

**Troutman**

Linsenspatel, 6 mm  
 Lens Spatula, 6 mm  
 Espátula para el Cristalino, 6 mm  
 Spatule pour la lentille cristalline, manche court



1/1



**H-1935**

**Neuhann-Nagahara**

Kernspalter und Linsenrotierer  
 Nucleus dividing hook and nucleus rotator  
 Gancho para separación de núcleo y rotator para núcleo  
 Crochet diviseur à noyau et crochet manipulateur



**H-1924**

**Neuhann**

Kernspalter und Linsenrotierer  
 Nucleus dividing hook and nucleus rotator  
 Gancho para separación de núcleo y rotator para núcleo  
 Crochet diviseur à noyau et crochet manipulateur

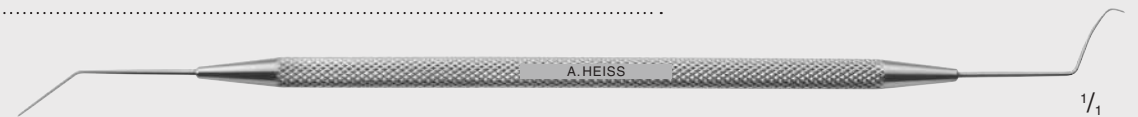
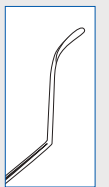

**H-1934**

**Neuhann**

Spatel und Kernspalter, 0.5 mm  
 Spatula and nucleus dividing hook, 0.5 mm  
 Gancho para separación de núcleo, espátula para el cristalino, 0.5 mm  
 Phako cliveur, spatule pour la lentille cristalline, 0.5 mm

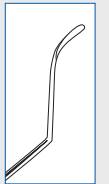

**H-1926**

**Neuhann**

Kernspalter  
 Nucleus dividing hook  
 Gancho para separación de núcleo  
 Crochet diviseur à noyau

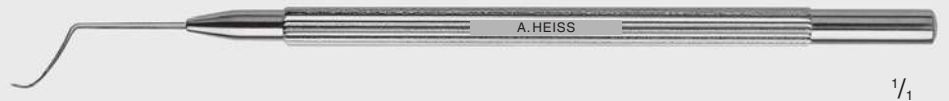
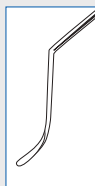

stark gebogen    :    curvo  
 strongly curved    :    courbe

**H-1926A**

**Neuhann**

Kernspalter, abgewinkelt  
 Nucleus dividing hook, angulated  
 Gancho para separación de núcleo, angulares  
 Crochet diviseur à noyau, coudé

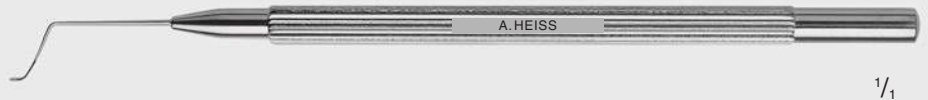
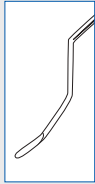

stark gebogen    curvo  
 strongly curved    courbe

**H-1947**

Kernspalter und Irishäkchen  
 Nucleus dividing hook and nucleus rotator  
 Gancho para separación de núcleo y rotator para núcleo de lente  
 Crochet manipulateuroyau et crochet manipulateur

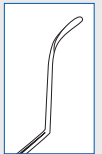
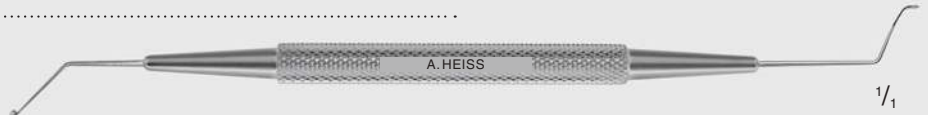

**H-2335**

**Nagahara-Koch**

Doppelinstrument, Kernspalter links, Linsenspatel  
 Phaco splitter left, lens spatula  
 Gancho para separación de núcleo espátula para el cristalino  
 Phako cliveur, spatule pour la lentille cristalline

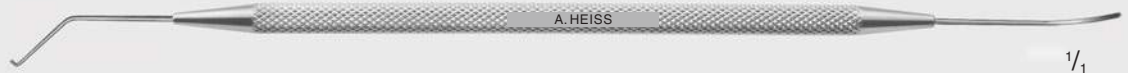

**H-2338**

**Nagahara-Jaffe**

Doppelinstrument, Kernspalter rechts, Spatel 0.5 mm  
 Phaco splitter right, lens spatula 0.5 mm  
 Gancho para separación de núcleo derecho, espátula para el cristalino 0.5 mm  
 Phako cliveur, droite, spatule pour la lentille cristalline 0.5 mm



**H-2339**

Doppelinstrument, Kernspalter links, Spatel 0.5 mm  
 Phaco splitter left, lens spatula 0.5 mm  
 Gancho para separación de núcleo izquierda, espátula para el cristalino 0.5 mm  
 Phako cliveur, gauche, spatule pour la lentille cristalline 0.5 mm

**H-1927**

**Rosen**

Kernspalter  
 Nucleus dividing hook  
 Gancho para separación de núcleo  
 Crochet diviseur à noyau, courbe



stumpfe Spitze    punta roma  
 blunt tip    bords mousses

**H-1928**

**Rosen**

Kernspalter, 60°  
 Nucleus dividing hook, 60°  
 Gancho para separación de núcleo, 60°  
 Crochet diviseur à noyau, courbe, 60°



stumpfe Spitze    punta roma  
 blunt tip    bords mousses



**H-1936**

**Rosen**

Kernspalter  
 Nucleus dividing hook  
 Gancho para separación de núcleo  
 Crochet diviseur à noyau, courbe



1/1

**H-1937**

**Rosen**

Kernspalter, 60°  
 Nucleus dividing hook, 60°  
 Gancho para separación de núcleo, 60°  
 Crochet diviseur à noyau, courbe, 60°



1/1

**H-1958**

**Dodick-Kammann**

Kernspalter, 1.5 mm lange Spitze, gerade  
 Nucleus dividing hook, 1.5 mm long tip, straight  
 Gancho para separación de núcleo, punta 1.5 mm, recta  
 Crochet diviseur à noyau, courbe, bords 1.5 mm, droit



**H-1958A**

abgewinkelt    :    angulada  
 angled            :    coudé

**H-1959**

**Dodick-Kammann**

Kernspalter, 2.0 mm lange Spitze, gerade  
 Nucleus dividing hook, 2.0 mm long tip, straight  
 Gancho para separación de núcleo, punta 2.0 mm, recta  
 Crochet diviseur à noyau, courbe, bords 2.0 mm, droit



**H-1959A**

abgewinkelt    :    angulada  
 angled            :    coudé

**H-1933**

**Fukasaku**

Phaco Nucleus Spalter  
 Phaco splitter  
 Phaco chopper / splitter  
 Diviseur à noyau

stumpfe Spitze    :    punta roma  
 blunt tip            :    bords mousses



1/1

**H-1938**

**Davidoff**

Kernspalter, stumpfe Spitze  
 Nucleus dividing hook, blunt tip  
 Gancho para separación de núcleo, punta roma  
 Crochet diviseur à noyau, courbe



1/1



### Tomahawk

Kernspalter, stumpfe Spitze  
 Nucleus dividing hook, blunt tip  
 Ganche para separación de núcleo  
 Tomahawk crochet diviseur à noyau



1/1

**H-1939A**

rechte Hand    :    mano derecho  
 right Hand    :    main droite

**H-1939B**

linke Hand    :    mano izquierdo  
 left Hand    :    main gauche



**H-1943**

### Minardi

Kernspalter, 0.7 mm lange Spitze „Quick Chop“  
 Nucleus dividing hook, 0.7 mm long tip, „Quick Chop“  
 Ganche para separación de núcleo, punta 0.7 mm, „Quick Chop“  
 Crochet diviseur à noyau, bords 0.7 mm, „Quick Chop“



1/1



**H-1984**

### Koch

Manipulationshäkchen  
 Manipulation hook  
 Ganche para manipulación  
 Crochet manipulateur



1/1



**H-1967L**

### Nagahara

Kernspalter, linke Hand  
 Phaco splitter, left hand  
 Ganche para separación de núcleo, mano izquierdo  
 Phako cliveur, gauche



1/1

**H-1967R**

rechte Hand    :    mano derecho  
 right hand    :    main droite



**H-1968L**

### Haeflinger

Kernspalter, rechte Hand  
 Phaco splitter, right hand  
 Ganche para separación de núcleo, mano derecho  
 Phako cliveur, droite



1/1

**H-1968R**

linke Hand    :    mano izquierdo  
 left hand    :    main gauche



**H-1969L**

### Chang

Mikro Finger Nucleus Manipulator für die linke Hand  
 Micro finger for use in left hand  
 Micro-finger manipulador para núcleo de lente, mano izquierda  
 Micro-manipulateur à noyau, main gauche



1/1

**H-1969R**

für die rechte Hand    :    mano derecho  
 for use in right hand    :    main droite

**H-1929**



**Tokuda**

Kernspalter und Separator  
 Nucleus divider and separator  
 Gancho para separación de núcleo  
 Crochet diviseur à noyau



1/1

**H-1940**

**Bucher-Kansas**

Kernspalter Trisector, 4 mm breit  
 Nucleus trisector, 4 mm wide  
 Gancho para separación de núcleo, trisector, 4 mm  
 Trisecteur de noyau, largeur 4 mm

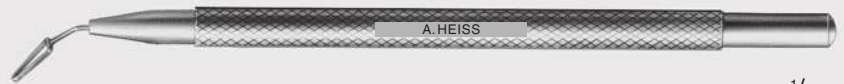

1/1

**H-1941**

**Kansas**

Kernspalter Bisector  
 Nucleus bisector  
 Gancho para separación de núcleo, bisector  
 Bisecteur de noyau



1/1

**H-1942**

**Kansas**

Kernspalter Vectis,  
 Nucleus vectis,  
 Gancho para separación  
 de núcleo, Vectis  
 Spatule guide, vectis

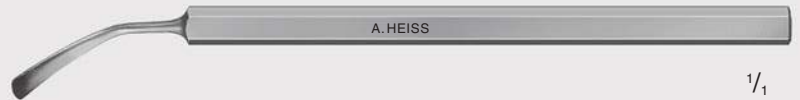

1/1

zur Verwendung mit    para  
 H1940 und H1941    H-1940 y H-1941  
 to be used with    pour  
 H1940 and H1941    H-1940 et H-1941

**H-1945**

**Keener**

Schlingeninstrument, komplett  
 Lens divider, complete  
 Cortador de lentes  
 Diviseur à noyau, complet



1/1

**H-1946**

Schlingen zu H-1945 (3 Stück)  
 Loops for H-1945 (3 pieces)  
 Set de tres asas paracortador des lentes (3 piezas)  
 Anses pour H-1945 (3 pièces)

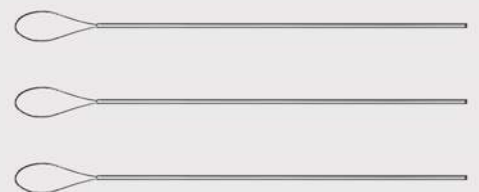

1/1



**H-2336**

**Chang-Liebermann**

Mikro Finger, Kernmanipulator, für die linke Hand  
 Micro finger, nucleus manipulator, for use in left hand  
 Micro finger, manipulador para núcleo de lente, mano izquierda  
 Micro-manipulateur à noyau, pour la main gauche



**H-2337**

**Chang-Liebermann**

Mikro Finger, Kernmanipulator, für die rechte Hand  
 Micro finger, nucleus manipulator, for use in right hand  
 Micro finger, manipulador para núcleo de lente, mano derecha  
 Micro-manipulateur à noyau, pour la main droite

**H-5740**

Mikro Finger, Nucleusspalter mit Irrigation, 20 ga  
 Micro finger, irrigating nucleus splitter, 20 ga  
 Micro finger, gancho para separación de núcleo, con irrigación, 20 ga  
 Micro-manipulateur à noyau avec irrigation, 20 ga



**H-5745**

**Dodick**  
 Nucleusspalter mit Irrigation, 20 ga  
 Irrigating nucleus splitter, 20 ga  
 Gancho para separación de núcleo, con irrigación, 20 ga  
 Micro-manipulateur à noyau avec irrigation, 20 ga



**H-5750**

**Rosen**  
 Nucleusspalter mit Irrigation, 20 ga  
 Irrigating nucleus splitter, 20 ga  
 Gancho para separación de núcleo, con irrigación, 20 ga  
 Micro-manipulateur à noyau avec irrigation, 20 ga





H-5755

**Fukasaku**

Nukleusspalter mit Irrigation, 20 ga  
 Irrigating nucleous splitter, 20 ga  
 Gancho para separación de núcleo, con irrigación, 20 ga  
 Micro-manipulateur à noyau avec irrigation, 20 ga



H-2003

**Blumenthal**

Bindehaut Dissektor  
 Conjunctiva dissector  
 Espatula para conjunctiva  
 Spatule pour conjonctive

1/1



H-2005

**Seibel**

Hornhaut-Flap-Spatel und Repositionsspatel  
 Flap lifter & retreatment spatula  
 Espatula para LASIK, doble  
 Dissecteur et spatule

1/1

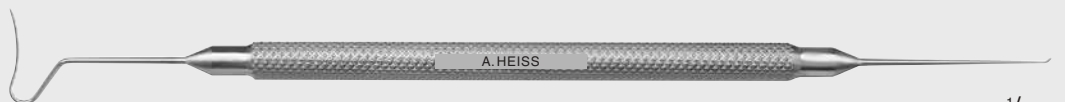

H-2005A

**Seibel**

Hornhaut-Flap-Spatel und Repositionsspatel  
 Flap lifter & retreatment spatula  
 Espatula para LASIK, doble  
 Dissecteur et spatule

1/1



H-2370

**Kimura**

Spatel, Platin  
 Spatula, platinum  
 Espatula, platino  
 Spatule, platine

1/1

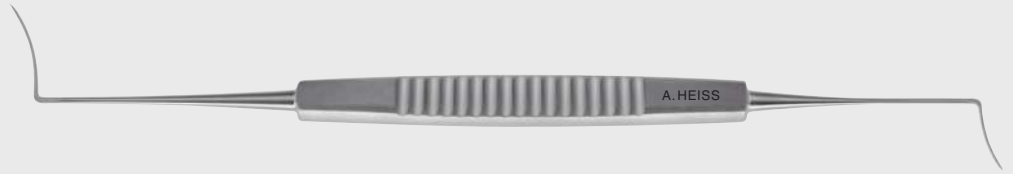

**H-2232**    **Castroviejo**  
Doppelspatel, 10 & 15 mm, 0.5 mm breit  
Spatule double, 10 & 15 mm, 0.5 mm wide  
Espátula doble, 10 & 15 mm, ancho 0.5 mm  
Spatule double, 10 & 15 mm, 0.5 mm le large

1/1

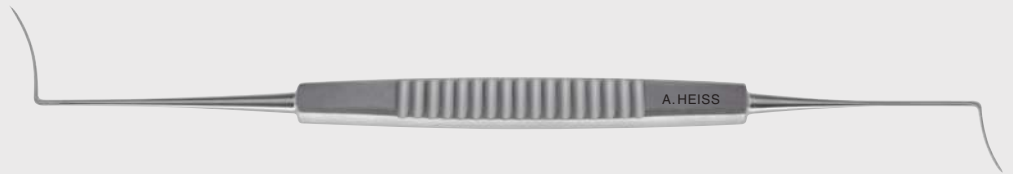

**H-2232A**    **Castroviejo**  
Doppelspatel, 10 & 15 mm, 0.25 mm breit  
Spatule double 10 & 15 mm, 0.25 mm wide  
Espátula doble, 10 & 15 mm, ancho 0.25 mm  
Spatule double, 10 & 15 mm, 0.25 mm le large

1/1



**H-1988**    **Girard**  
Synechienspatel, 0.5 mm  
Synechiae spatula, 0.5 mm  
Espátula para synequia, 0.5 mm  
Spatule à synéchies, 0.5 mm

1/1



**H-1923**



DSAEK Descemet Spatel  
 DSAEK Spatula, for descemet's stripping  
 DSAEK Espátula  
 DSAEK Spatule

1/1

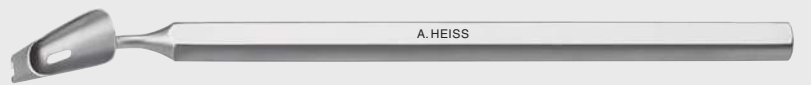

**H-2380**

DSAEK Implantationsspatel  
 DSAEK Glide spatula  
 DSAEK Espátula corredera  
 DSAEK Spatule glissière

1/1



**H-1971B**



**Sinskey**  
 Häkchen, Ø 0.2 mm, 180° gedreht, abgewinkelt  
 Hook reversed, Ø 0.2 mm, angled 180°  
 Gancho, Ø 0.2 mm, girado por 180°, angulado, roma  
 Crochet, Ø 0.2 mm, retourné, coudé

1/1



**H-2090**

Druckplatte  
 Pressure plate  
 Placa de presión  
 Plateau de pression

1/1

**Camellin**

LASEK Alkoholtrichter  
 LASEK Alcohol well  
 LASEK Embudo de alcohol  
 LASEK enntonoir pour alcool



**H-2050**    8.5 mm

**H-2051**    9.5 mm

LASEK Trepan  
 LASEK Trepine  
 Trepano para LASEK  
 Trépan LASEK



**H-2565**    8.0 mm

**H-2566**    9.0 mm

**H-2054**    LASEK Epithelspatel,  
 scharfe Vorderseite  
 LASEK Epi peeler,  
 sharp tip  
 Espatula para LASEK  
 Spatule LASEK



**H-2055**    **Sloane**  
 LASEK Epithelrechen  
 LASEK Micro hoe  
 LASEK Micro-restrillo para epitelio  
 LASEK Mikro Houe, semi-tranchante



**H-2056**    **Sloane**  
 LASEK Repositionsspatel, gebogen, stumpf  
 LASEK Flap reposer, curved, blunt  
 Espatula para LASEK, curva, redonda  
 LASEK Spatule pour réposition, courbe, mousse



**H-2058**    **Sloane**  
 LASEK Epithelspatel  
 LASEK Epi peeler  
 Espatula para LASEK  
 Spatule LASEK, bords semi-tranchants



**H-2059**    **Sloane**  
 LASEK Epitheldissektor  
 LASEK Epi dissector  
 Espatula para LASEK  
 Dissecteur LASEK





H-2000



**Katzen**

LASIK Hornhaut-Flap Spatel  
 LASIK Flap "unzipper"  
 LASIK Espatula para colgajo de cornea  
 LASIK Spatule pour la cornée



1/1

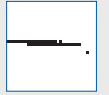

H-2001

**Maddox**

LASIK Doppelspatel  
 LASIK Spatula, double end  
 Espatula para LASIK, doble  
 LASIK Spatule double

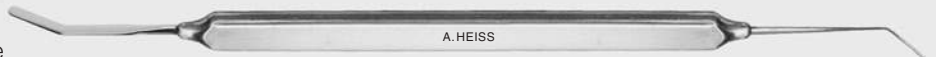

1/1

H-2002



**Guimaraes**

LASIK Spatel, leicht gebogen  
 LASIK Spatula, gently curved  
 Espatula para LASIK, curva  
 LASIK Spatule, courbe



1/1

H-2009

**Buratto**

LASIK Flapprotector  
 LASIK Flap protector  
 Protector de colgajo para LASIK  
 LASIK volet de protection



1/1

H-2010

**Buratto**

LASIK Flapprotector  
 LASIK Flap Pprotector  
 LASIK Protector de colgajo  
 LASIK volet de protection



1/1

H-2011

**Mannis-Buratto**

LASIK Flapprotector  
 LASIK Flap protector  
 Protector de colgajo para LASIK  
 LASIK volet de protection



1/1

H-2057



**Fukasaku**

LASIK Spatel, abgewinkelt  
 LASIK Spatula, angulated  
 Espatula para LASIK, angular, delicada  
 Spatule pour LASIK, coudé



1/1

**Bangerter**  
Spatel  
Spatula  
Espátula  
Spatule



Zyklodialysespatel  
Cyclodialisis spatula  
Espátula para ciclodialísis  
Spatule pour cyclodialyse

**Castroviejo**

Zyklodialysespatel  
Cyclodialisis spatula  
Espátula para ciclodialisis  
Spatule pour cyclodialyse



Keratoplastikspatel  
Keratoplasty spatula  
Espátula para queratoplastia  
Spatule pour k eratoplastie

H-2015

**Art**

Drahtschlinge, gerieft, 4 mm  
 Lens loop, serrated, 4 mm  
 Asa, estriada, 4 mm  
 Anse, striée, 4 mm



1/1

H-2020

**Snellen**

Drahtschlinge, 4 mm  
 Lens loop, 4 mm  
 Asa, 4 mm  
 Anse, 4 mm

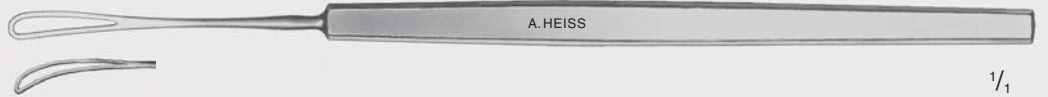

1/1

H-2022

New Orleans, Drahtschlinge, 5 mm  
 New Orleans, Lens loop, 5 mm  
 New Orleans, Asa, 5 mm  
 New Orleans, Anse, 5 mm



1/1

**Weber**

Drahtschlinge  
 Lens loop  
 Asa  
 Anse

H-2025/1

klein  
 small  
 pequeña  
 petit

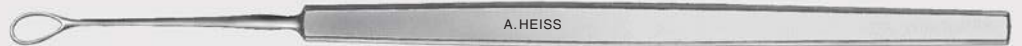

1/1

H-2025/2

groß  
 large  
 grande  
 grand

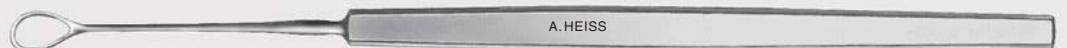

1/1

H-2325

**Kirby**

Drahtschlinge, runder Griff  
 Lens loop, round handle  
 Asa, mango redondo  
 Anse, manche rond



1/1

H-2065

**Wells**

Enukleationslöffel  
 Enucleation spoon  
 Espátula para enucleación  
 Spatule échancrée pour énucléer



1/1



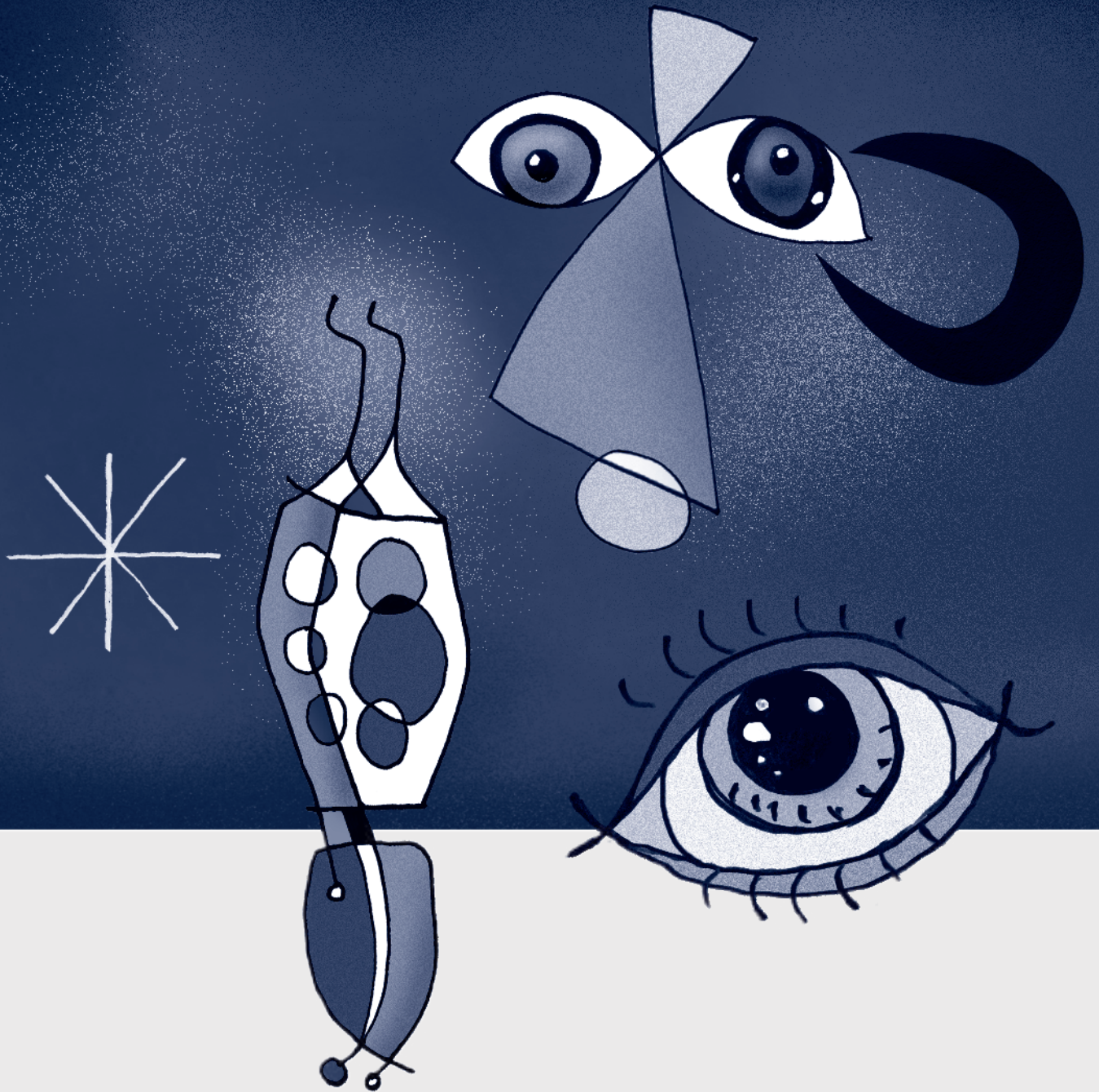

4

..... Pinzetten  
..... Forceps  
..... Pinzas  
..... Pincas  
.....



**H-3000** Irispinzette, gerade, 0.7 mm, gerieft, 10 cm  
Iris forceps, straight, 0.7 mm, serrated, 10 cm  
Pinza para iris recta, 0.7 mm, estriada, 10 cm  
Pince à iris, droite, 0.7 mm, striée, 10 cm



1/1

**H-3001** Irispinzette, schwach gebogen, 0.7 mm, gerieft, 10 cm  
Iris forceps, half-curved, 0.7 mm, serrated, 10 cm  
Pinza para iris, curva aguda, 0.7 mm, estriada, 10 cm  
Pince à iris, à faible courbure, 0.7 mm, striée, 10 cm



1/1

**H-3002** Irispinzette, stark gebogen, 0.7 mm, gerieft, 10 cm  
Iris forceps, full-curved, 0.7 mm, serrated, 10 cm  
Pinza para iris, curva fuerte, 0.7 mm, estriada, 10 cm  
Pince à iris, à forte courbure, 0.7 mm, striée, 10 cm



1/1

**H-3010** Irispinzette, gerade, 0.7 mm, 1 × 2 Zähne, 10 cm  
Iris forceps, straight, 0.7 mm, 1 × 2 teeth, 10 cm  
Pinza para iris, recta, 0.7 mm, 1 × 2 dientes, 10 cm  
Pince à iris, droite, 0.7 mm, à 1 × 2 griffes, 10 cm



1/1

**H-3011** Irispinzette, schwach gebogen, 0.7 mm, 1 × 2 Zähne, 10 cm  
Iris forceps, half-curved, 0.7 mm, 1 × 2 teeth, 10 cm  
Pinza para iris, curva aguda, 0.7 mm, 1 × 2 dientes, 10 cm  
Pince à iris, demi-courbe, 0.7 mm, à 1 × 2 griffes, 10 cm



1/1

**H-3012** Irispinzette, stark gebogen, 0.7 mm, 1 × 2 Zähne, 10 cm  
Iris forceps, full-curved, 0.7 mm, 1 × 2 teeth, 10 cm  
Pinza para iris, curva fuerte, 0.7 mm, 1 × 2 dientes, 10 cm  
Pince à iris, à forte courbure, 0.7 mm, à 1 × 2 griffes, 10 cm



1/1

**H-3030**

Irispinzette, gerade, gerieft, 7 cm  
Iris forceps, straight, serrated, 7 cm  
Pinza para iris, recta, estriada, 7 cm  
Pince à iris, droite, striée, 7cm



1/1

**H-3031**

Irispinzette, gebogen gerieft, 7 cm  
Iris forceps, curved, serrated, 7 cm  
Pinza para iris, curva, estriada, 7 cm  
Pince à iris, courbe, striée, 7 cm



1/1

**H-3020**

Irispinzette, gerade 1 × 2 Zähne, 7 cm  
Iris forceps, straight, 1 × 2 teeth, 7 cm  
Pinza para iris, recta, 1 × 2 dientes, 7 cm  
Pince à iris, à 1 × 2 griffes, droite, 7 cm



1/1

**H-3021**

Irispinzette, gebogen 1 × 2 Zähne, 7 cm  
Iris forceps, curved, 1 × 2 teeth, 7 cm  
Pinza para iris, curva, 1 × 2 dientes, 7 cm  
Pince à iris, à 1 × 2 griffes, courbe, 7 cm



1/1

**H-3111**

**Bishop-Harmon**

Irispinzette, gerade, gerieft, 0,7 mm, 8,5 cm  
Iris forceps, straight, serrated, 0,7 mm, 8,5 cm  
Pinza para iris, recta, estriada, 0,7 mm, 8,5 cm  
Pince à iris, striée, fine, 0,7 mm, 8,5 cm



1/1

**H-3111A**

**Bishop-Harmon**

Irispinzette, gerade, gerieft, 0,3 mm, 8,5 cm  
Iris forceps, straight, serrated, 0,3 mm, 8,5 cm  
Pinza para iris, recta, estriada, 0,3 mm, 8,5 cm  
Pince à iris, striée, fine, 0,3 mm, 8,5 cm



1/1

**H-3112 Bishop-Harmon**



Irispinzette, kreuzgerieft, fein, 0.7 mm  
Eye dressing forceps, cross-serrated, 0.7 mm  
Pinza para iris, estriada, fina, 0.7 mm  
Pince à iris, striée, fine, 0.7 mm



1/1

**H-3112A Bishop-Harmon**



Irispinzette, kreuzgerieft, fein, 0.3 mm  
Eye dressing forceps, cross-serrated, 0.3 mm  
Pinza para iris, estriada, fina, 0.3 mm  
Pince à iris, striée, fine, 0.3 mm



1/1

**H-3110 Bishop-Harmon**



Irispinzette, gerade, 1 × 2 Zähne, 0.7 mm, 8.5 cm  
Iris forceps, straight, 1 × 2 teeth, 0.7 mm, 8.5 cm  
Pinza para iris, recta, 1 × 2 dientes, 0.7 mm, 8.5 cm  
Pince à iris, à 1 × 2 griffes, 0.7 mm, 8.5 cm



1/1

**H-3110A Bishop-Harmon**



Irispinzette, gerade, 1 × 2 Zähne, 0.3 mm, 8.5 cm  
Iris forceps, straight, 1 × 2 teeth, 0.3 mm, 8.5 cm  
Pinza para iris, recta, 1 × 2 dientes, 0.3 mm, 8.5 cm  
Pince à iris, à 1 × 2 griffes, fine, 0.3 mm, 8.5 cm



1/1

**H-3100 Irispinzette, Schweizer Modell, gebogen, 1 × 2 Zähne, 9.5 cm**

Iris forceps, Swiss model, curved, 1 × 2 teeth, 9.5 cm  
Pinza para iris modelo suizo, curva, 1 × 2 dientes, 9.5 cm  
Pince à iris, modèle suisse, courbe, fine, à 1 × 2 griffes, 9.5 cm



1/1

**H-3105 Graefe**

Irispinzette, gebogen, 1 × 2 Zähne, 8 cm  
Iris forceps, curved, 1 × 2 teeth, 8 cm  
Pinza para iris, curva, 1 × 2 dientes, 8 cm  
Pince à iris, à 1 × 2 griffes, fine, 8 cm



1/1

**H-3158 Bracken**

Irispinzette, gebogen, gerieft, 10.5 cm  
Iris forceps, curved, serrated, 10.5 cm  
Pinza para iris, curva, estriada, 10.5 cm  
Pince à iris, courbe, striée, 10.5 cm



1/1



**H-3331 Osher**  
 Irispinzette, 45° abgewinkelt, 11 cm  
 Iris forceps, 45° angled, 11 cm  
 Pinzas para iris, 45° angulada, 11 cm  
 Pince de joaillier à iris, coudée 45°, 11 cm



1/1

**H-3140 Hess**  
 Irispinzette, Schweizer Modell,  
 1 × 2 Zähne, 9.5 cm  
 Iris forceps, Swiss model,  
 1 × 2 teeth, 9.5 cm  
 Pinza para iris, modelo suizo,  
 1 × 2 dientes, 9.5 cm  
 Pince à iris, modèle suisse, très fine,  
 à 1 × 2 griffes, 9.5 cm



1/1

**H-3145 Hess**  
 Irispinzette, Standard Modell, 1 × 2 Zähne, 7 cm  
 Iris forceps, standard model, 1 × 2 teeth, 7 cm  
 Pinza para iris, modelo clásico, 1 × 2 dientes, 7 cm  
 Pince à iris, modèle classique, fine, à 1 × 2 griffes, 7 cm



1/1

**H-3584 Gill**  
 Irispinzette gebogen, 1 × 2 Zähne, 7 cm  
 Iris forceps, curved, 1 × 2 teeth, 7 cm  
 Pinza para iris, curva, 1 × 2 dientes, 2, 7 cm  
 Pince à iris, courbe, à 1 × 2 griffes, 7 cm



1/1

**H-3592 Gill-Hess**  
 Mikro-Irispinzette, 1 × 2 Zähne, 0.2 mm, 7 cm  
 Micro-iris forceps, 1 × 2 teeth, 0.2 mm, 7 cm  
 Micro-pinza para iris, 1 × 2 dientes, 0.2 mm, 7 cm  
 Micro-pince à iris, à 1 × 2 griffes, 0.2 mm, 7 cm



1/1

**H-3004**  
 Irispinzette, bajonettförmig gebogen  
 Iris forceps, bayonet-shaped  
 Pinza para iris, bayoneta  
 Pincas à iris, baïonnette



1/1



1/1

**H-3133**

Mikro-Irispinzette, Modell Bonn, 1 × 2 Zähne, 0.12 mm, gerade, 7 cm  
Micro-iris forceps, Bonn model, 1 × 2 teeth, 0.12 mm, straight, 7 cm  
Micro-pinza para iris, modelo Bonn, 1 × 2 dientes, 0.12 mm, recta, 7 cm  
Micro-pince à iris, modèle Bonn, à 1 × 2 griffes, 0.12 mm, droite, 7 cm



1/1

**H-3132**

Mikro-Irispinzette, Modell Bonn, 1 × 2 Zähne, 0.12 mm, gerade, mit Fadenplatte, 7 cm  
Micro-iris forceps, Bonn model, 1 × 2 teeth, 0.12 mm, straight, with tying platform, 7 cm  
Micro-pinza para iris, modelo Bonn, 1 × 2 dientes, 0.12 mm, recta, con plataforma, 7 cm  
Micro-pince à iris, modèle Bonn, à 1 × 2 griffes, 0.12 mm, droite, avec plateforme, 7 cm



1/1

**H-3133A**

Mikro-Irispinzette, Modell Bonn, gerieft, gerade, 7 cm  
Micro-iris forceps, Bonn model, serrated, straight, 7 cm  
Micro-pinza para iris, modelo Bonn, estriada, recta, 7 cm  
Micro-pince à iris, modèle Bonn, striée, droite, 7 cm



1/1

**H-3135**

Mikro-Irispinzette, Modell Bonn, 1 × 2 Zähne, 0.12 mm, abgewinkelt, 6 mm, 7 cm  
Micro-iris forceps, Bonn model, 1 × 2 teeth, 0.12 mm, angulated, 6 mm, 7 cm  
Micro-pinza para iris, modelo Bonn, 1 × 2 dientes, 0.12 mm, angulares, 6 mm, 7 cm  
Micro-pince à iris, modèle Bonn, à 1 × 2 griffes, 0.12 mm, coudée, 6 mm, 7 cm



1/1

**H-3135A**

Mikro-Irispinzette, Modell Bonn, gerieft, abgewinkelt, 6 mm, 7 cm  
Micro-iris forceps, Bonn model, serrated, angulated, 6 mm, 7 cm  
Micro-pinza para iris, modelo Bonn, estriada, angulares, 6 mm, 7 cm  
Micro-pince à iris, modèle Bonn, condée striée, coudée, 6 mm, 7 cm





1/1

**H-3136**

Mikro-Irispinzette, Modell Bonn, 1 × 2 Zähne, 0.12 mm, mit Fadenplatte, runder Griff, 10.5 cm  
Micro-iris forceps, Bonn model, 1 × 2 teeth, 0.12 mm, with tying platform, round handle, 10.5 cm  
Micro-pinza para iris, modelo Bonn, 1 × 2 dientes, 0.2 mm, con plataforma, mango redondo, 10.5 cm  
Micro-pince à iris, modèle Bonn, à 1 × 2 griffes, 0.12 mm, avec plateforme, manche rond, 10.5 cm



1/1

**H-3137**

Mikro-Irispinzette, Modell Bonn, 1 × 2 Zähne, 0.12 mm, mit Fadenplatte, runder Griff, 11.5 cm  
Micro-iris forceps, Bonn model, 1 × 2 teeth, 0.12 mm, with tying platform, round handle, 11.5 cm  
Micro-pinza para iris, modelo Bonn, 1 × 2 dientes, 0.12 mm, con plataforma, mango redondo, 11.5 cm  
Micro-pince à iris, modèle Bonn, à 1 × 2 griffes, 0.12 mm, avec plateforme, manche rond, 11.5 cm



1/1

**H-3138**

Mikro-Irispinzette, Modell Bonn, mit Fadenplatte, 1 × 2 Zähne, 0.12 mm  
Micro-iris forceps, Bonn model, with tying platform, 1 × 2 teeth, 0.12 mm  
Micro-pinza para iris, modelo Bonn, largo, con plataforma, 1 × 2 dientes, 0.12 mm  
Micro-pince à iris, modèle Bonn, avec plateforme, à 1 × 2 griffes, 0.12 mm



1/1

**H-3139**

Mikro-Irispinzette, Modell Bonn, mit Fadenplatte, 1 × 2 Zähne, 0.2 mm  
Micro-iris forceps, Bonn model, with tying platform, 1 × 2 teeth, 0.12 mm  
Micro-pinza para iris, modelo Bonn, largo, con plataforma, 1 × 2 dientes, 0.12 mm  
Micro-pince à iris, modèle Bonn, avec plateforme, à 1 × 2 griffes, 0.12 mm



**H-3170**

Anatomische Pinzette, gerade, 1 mm, 10 cm  
Dressing forceps, straight, 1 mm, 10 cm  
Pinza de disección, recta, 1 mm, 10 cm  
Pince à disséquer, striée, droite, 1 mm, 10 cm



1/1

**H-3172**

Chirurgische Pinzette, gerade, 1 mm, mit 1 x 2 Zähnen, 10 cm  
Utility forceps, straight, 1 mm, with 1 x 2 teeth, 10 cm  
Pinza de disección, recta, 1 mm, 1 x 2 dientes, 10 cm  
Pince à conjonctive, droite, 1 mm, à 1 x 2 griffes, 10 cm



1/1

**H-3180**

**McCullough**

anatomische Pinzette, gerieft, 9.5 cm  
Utility forceps, serrated, 9.5 cm  
Pinza de disección, estriada, 9.5 cm  
Pince à disséquer, striée, 9.5 cm



1/1

**H-3182**

**McCullough**

Nahtpinzette, 1 x 2 Zähne und Riefen, 9.5 cm  
Suture forceps, 1 x 2 teeth and serration, 9.5 cm  
Pinza de disección, 1 x 2 dientes y estriada, 9.5 cm  
Pince pour sutures, à 1 x 2 griffes et striée, 9.5 cm



1/1

**H-3185**

**Wills Hospital**

Allzweckpinzette, gerieft, 10 cm  
Utility forceps, serrated, 10 cm  
Pinza utility, estriada, 10 cm  
Pince à dissection standard, striée, 10 cm



1/1



**H-3186**

**Adson**

Anatomische Pinzette, gerieft, 12 cm  
 Dressing Forceps, serrated, 12 cm  
 Pinza de disección, estriada, 12 cm  
 Pince à disséquer, striée, 12 cm

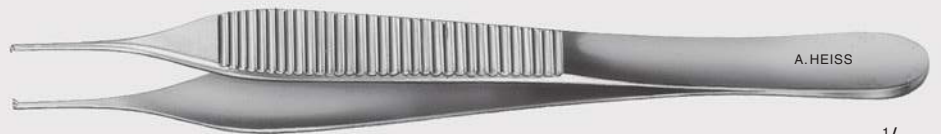

**H-3188**

**Adson**

Chirurgische Pinzette, 1 × 2 Zähne, 12 cm  
 Utility forceps, 1 × 2 teeth, 12 cm  
 Pinza de disección, 1 × 2 dientes, 12 cm  
 Pince à conjonctive, à 1 × 2 griffes, 12 cm



**H-3006**

**Troeltsch**

Nasentamponpinzetten  
 Nasal tampon forceps  
 Pinzas para taponamiento  
 Pincas à pansements

H-3190

**Bonaccolto**

Allzweckpinzette, gerieft, 1.3 mm, schmal, 10 cm  
Utility forceps, serrated, narrow, 1.3 mm, 10 cm  
Pinza utility, estriada, estrecha, 1.3 mm, 10 cm  
Pince "utility", étroite, 1.3 mm, 10 cm



1/1

H-3192

**Bonaccolto**

Allzweckpinzette, gerieft, breit, 1.9 mm, 10 cm  
Utility forceps, serrated, wide, 1.9 mm, 10 cm  
Pinza utility, estriada, ancha, 1.9 mm, 10 cm  
Pince "utility", large, 1.9 mm, 10 cm



1/1

H-3195

**Nugent**

Allzweckpinzette, glattes Maul, 10 cm  
Utility forceps, smooth jaws, 10 cm  
Pinza utility, lisa, 10 cm  
Pince "utility", lisse, 10 cm

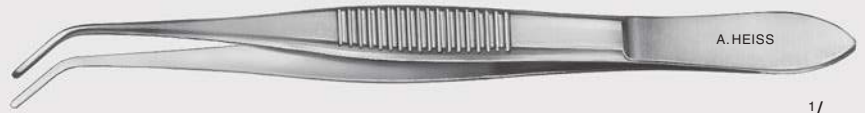

1/1

H-3195A

**Nugent**

Allzweckpinzette, gerieft, 10 cm  
Utility forceps, serrated, 10 cm  
Pinza "utility", estriada, 10 cm  
Pince "utility", striée, 10 cm



1/1

H-3530

**Arruga**

Kapselpinzette, Standardmodell, 10 cm  
Capsular forceps, standard model, 10 cm  
Pinza capsular, modelo clásico, 10 cm  
Pince capsulaire, modèle classique, 10 cm



1/1

H-3535

**Arruga**

Kapselpinzette, neue Biegung, 10 cm  
Capsular forceps, new curve, 10 cm  
Pinza capsular, curvatura nueva, 10 cm  
Pince capsulaire, courbe nouvelle, 10 cm



1/1

H-3550

**Castroviejo**

Kapselpinzette, gekreuzt, 9.5 cm  
Capsular forceps, cross action, 9.5 cm  
Pinza capsular, con ramas cruzadas, 9.5 cm  
Pince capsulaire à branches croisées, 9.5 cm



1/1

H-3545



Fasspinzette für Skleranägel  
Grasping forceps for scleral plugs  
Pinza porta clavo escleral  
Pince pour "scleral plug"



1/1

H-6093



Mermoud

Glaukom Pinzette, 11 mm lange Schenkel, gerade, Griff 6 mm  
Glaucoma forceps, shanks 11 mm, straight, handle 6 mm  
Pinza glaucoma, lados de un largo 11 mm, recta, mango 6 mm  
Pince pour glaucome, branches 11 mm, droit, manche 6 mm



1/1



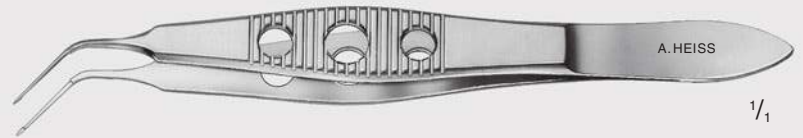

H-6180

**Kraft**

Kapselpinzette, 11 mm Maulteile, 1.5 mm Fadenplatte, 10.5 cm  
Capsule tag forceps, 11 mm long jaws, 1.5 mm platform, 10.5 cm  
Pinza capsular, largo de 11 mm, plataforma 1.5 mm, 10.5 cm  
Pince capsulaire, 11 mm, plateforme 1.5 mm, 10.5 cm



H-3676

**Von Barsewisch**

Vorderkammerpinzette, 7 mm Maulteile, 1.5 mm Fadenplatte  
Anterior chamber forceps, 7 mm long jaws, 1.5 mm platform  
Pinza con cámara anterior, largo de 7 mm, plataforma 1.5 mm  
Pince pour chambre antérieure, 7 mm, avec plateforme 1.5 mm

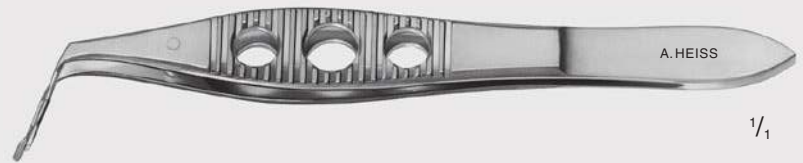

H-6200

**Ernest**

Nukleusteiler, gekreuzt, sehr fein, 10.5 cm  
Nucleus cracker, cross action, very delicate, 10.5 cm  
Separador para núcleo del cristalino, delicadísimo, 10.5 cm  
Séparateur pour noyau, délicat, 10.5 cm



H-6205

**Dodick**

Nukleusteiler, gekreuzt, sehr fein, 10.5 cm  
Nucleus cracker, cross action, very delicate, 10.5 cm  
Separador para núcleo del cristalino, delicadísimo, 10.5 cm  
Séparateur pour noyau, très fine, 10.5 cm





**H-6062 Akahoshi**  
 Pre-Chopper, 11.5 cm, für 2.2 mm Inzision, halbscharf  
 Pre-Chopper, 11.5 cm, for 2.2 mm incisions, semi sharp  
 Pre-Chopper, 11.5 cm, para incisión de 2.2 mm, semi cortantes  
 Pre-Chopper, 11.5 cm, pour incision de 2.2 mm, semi-tranchantes



**H-6010 Lehner**  
 Kapsulorhexis Pinzette, sehr fein, 10.5 cm  
 Capsulorhexis forceps, very delicate grasping tips, 10.5 cm  
 Pinza para capsulorhexis, extra delicada, 10.5 cm  
 Pince pour capsulorhexis, très fine, 10.5 cm



**H-6015 Utrata**  
 Kapsulorhexis Pinzette, sehr fein, 10.5 cm  
 Capsulorhexis forceps, very delicate grasping tips, 10.5 cm  
 Pinza para capsulorhexis, extra delicada, 10.5 cm  
 Pince pour capsulorhexis, très fine, 10.5 cm



**H-6015A Utrata**  
 Kapsulorhexis Pinzette sehr fein, 10.5 cm, geriefte Spitze  
 Capsulorhexis forceps, very delicate, 10.5 cm, serrated tip  
 Pinza para capsulorhexis, extra delicada, 10.5 cm, estriada-cruz  
 Pince pour capsulorhexis, très fine, 10.5 cm, mors strié



**H-6016 Jaffe**  
 Kapsulorhexis Pinzette, runde Spitzen, 10.5 cm  
 Capsulorhexis forceps, round tips, 10.5 cm  
 Pinza para capsulorhexis, puntas redondas, 10.5 cm  
 Pince pour capsulorhexis, extrémité mousse, 10.5 cm



H-6082

**Crozafon**



MICS Kapsulorhexis Pinzette, maximale Maulöffnung 2 mm für 1.5 mm Inzision  
MICS Capsulorhexis forceps, maximum jaw opening 2 mm for 1.5 mm incisions  
MICS Pinza capsulorhexis, abertura máximo 2 mm, para incisión de 1.5 mm  
MICS Pince pour capsulorhexis, ouverture maximum 2 mm, pour incision de 1.5 mm



H-6083

**Giannetti**



MICS Kapsulorhexis Pinzette, maximale Maulöffnung 2 mm für 1.5 mm Inzision  
MICS Capsulorhexis forceps, maximum jaw opening 2 mm for 1.5 mm incisions  
MICS Pinza capsulorhexis, abertura máximo 2 mm, para incisión de 1.5 mm  
MICS Pince pour capsulorhexis, ouverture maximum 2 mm, pour incision de 1.5 mm



H-6084

**Giannetti**



MICS Kapsulorhexis Pinzette, maximale Maulöffnung 2 mm für 1.5 mm Inzision  
MICS Capsulorhexis forceps, maximum jaw opening 2 mm for 1.5 mm incisions  
MICS Pinza capsulorhexis, abertura máximo 2 mm, para incisión de 1.5 mm  
MICS Pince pour capsulorhexis, ouverture maximum 2 mm, pour incision de 1.5 mm



H-6085

**Crozafon**



MICS Kapsulorhexis Pinzette, maximale Maulöffnung 2 mm für 1.5 mm Inzision  
MICS Capsulorhexis forceps, maximum jaw opening 2 mm for 1.5 mm incisions  
MICS Pinza capsulorhexis, abertura máximo 2 mm, para incisión de 1.5 mm  
MICS Pince pour capsulorhexis, ouverture maximum 2 mm, pour incision de 1.5 mm

**Inamura**

Kapsulorhexis Pinzette, gekreuzt  
Capsulorhexis forceps, cross-action  
Pinza para capsulorhexis, cruzada  
Pince pour capsulorhexis, croisée

H-6094

Edelstahl  
Stainless steel  
Acero inoxidable  
Acier inoxydable

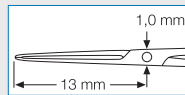

HT-6094

Titan  
Titanium  
Titanio  
Titane

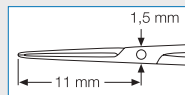



H-6087

**Corydon**

MICS Kapsulorhexis Pinzette, für 2.2 mm Inzision, 12 mm lange Schenkel  
MICS Capsulorhexis forceps for 2.2 mm incisions, 12 mm long shanks  
MICS Pinza capsulorhexis, para incisión de 2.2 mm, lados de un largo de 12 mm  
MICS Pince pour capsulorhexis, pour incision de 2.2 mm, branches 12 mm



1/1



H-6087G

**Corydon**

MICS Kapsulorhexis Pinzette mit Skala, für 2.2 mm Inzision, 12 mm lange Schenkel  
MICS Capsulorhexis forceps for 2.2 mm incisions, 12 mm long graduated shanks  
MICS Pinza capsulorhexis, para incisión de 2.2 mm, lados de un largo de 12 mm, graduato  
MICS Pince pour capsulorhexis, pour incision de 2.2 mm, branches 12 mm, graduer



1/1



H-6088

**Corydon**

MICS Kapsulorhexis Pinzette, für 2.2 mm Inzision, 12 mm lange Schenkel  
MICS Capsulorhexis forceps for 2.2 mm incisions, 12 mm long shanks  
MICS Pinza capsulorhexis, para incisión de 2.2 mm, lados de un largo de 12 mm  
MICS Pince pour capsulorhexis, pour incision de 2.2 mm, branches 12 mm



1/1



H-6088G

**Corydon**

MICS Kapsulorhexis Pinzette mit Skala, für 2.2 mm Inzision, 12 mm lange Schenkel  
MICS Capsulorhexis forceps for 2.2 mm incisions, 12 mm long graduated shanks  
MICS Pinza capsulorhexis, para incisión de 2.2 mm, lados de un largo de 12 mm, graduato  
MICS Pince pour capsulorhexis, pour incision de 2.2 mm, branches 12 mm, graduer



1/1



H-6012

**Utrata**

Micro Kapsulorhexis Pinzette, für 1.8 mm Inzision, 13 mm, 8,5 cm  
Micro capsulorhexis forceps, for 1.8 mm incisions, 13.0 mm shanks, 8.5 cm long  
Pinza para capsulorhexis, para incisión de 1.8 mm, lados de un largo de 13 mm, 8.5 cm  
Pinza para capsulorhexis, pour incision de 1.8 mm, branches 13 mm, 8.5 cm



1/1

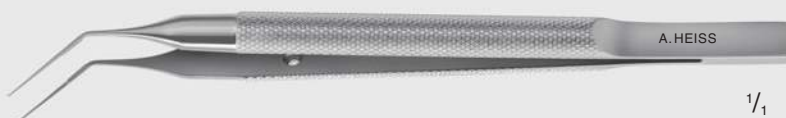

H-6013

**Utrata**

Micro Kapsulorhexis Pinzette, für 1.8 mm Inzision, 13 mm, 10,5 cm  
Micro capsulorhexis forceps, for 1.8 mm incisions, 13.0 mm shanks, 10.5 cm long  
Pinza para capsulorhexis, para incisión de 1.8 mm, lados de un largo de 13 mm, 10.5 cm  
Pinza para capsulorhexis, pour incision de 1.8 mm, branches 13 mm, 10.5 cm



1/1



**H-6017** Kapsulorhexis Pinzette, Typ Utrata, 0.6 mm  
Capsulorhexis forceps, Utrata style, 0.6 mm  
Pinza para capsulorhexis, tipo Utrata, 0.6 mm  
Pince pour capsulorhexis, type Utrata, 0.6 mm



1/1



**H-6019** Kapsulorhexis Pinzette, Typ Utrata, 0.6 mm, Titangriff  
Capsulorhexis forceps, Utrata style, 0.6 mm, titanium handle  
Pinza para capsulorhexis, tipo Utrata, 0.6 mm, mango de Titanio  
Pince pour capsulorhexis, type Utrata, 0.6 mm, manche titane



1/1



**H-6019A** Kapsulorhexis Pinzette, Typ Utrata, 0.6 mm, Titangriff  
Capsulorhexis forceps, Utrata style, 0.6 mm, titanium handle  
Pinza para capsulorhexis, tipo Utrata, 0.6 mm, mango de Titanio  
Pince pour capsulorhexis, type Utrata, 0.6 mm, manche titane



1/1



**H-6080 Masket**  
Kapsulorhexis Pinzette, 12 mm lange Schenkel, gebogen, Griff Ø 6 mm, 10.5 cm  
Capsulorhexis forceps, 12 mm vaulted shanks, handle Ø 6 mm, 10.5 cm  
Pinza para capsulorhexis, lados de un largo de 12 mm, mango Ø 6 mm, 10.5 mm  
Pince pour capsulorhexis, branches 12 mm, courbe, manche rond 6 mm, 10.5 cm



1/1



**H-6081 Masket**  
Kapsulorhexis Pinzette, 11 mm lange Schenkel, gebogen, Griff Ø 8 mm, 10.5 cm  
Capsulorhexis forceps, 11 mm vaulted shanks, handle Ø 8 mm, 10.5 cm  
Pinza para capsulorhexis, lados de un largo de 11 mm, mango Ø 8 mm, 10.5 cm  
Pince pour capsulorhexis, branches 11 mm, courbe, manche Ø 8 mm, 10.5 cm



1/1

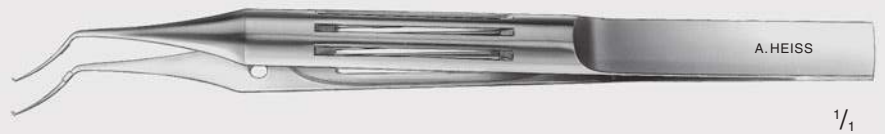

### H-6081A Corydon



Kapsulorhexispinzette, 11 mm lange Schenkel, geriefte Spitze  
Capsulorhexis forceps, 11 mm long shanks, serrated tip  
Pinza para capsulorhexis, lados de un largo 11 mm, estriada-cruz  
Pince pour capsulorhexis, branches 11 mm, mors strié



### H-6090 Utrata



Kapsulorhexis Pinzette, 12 mm lange Schenkel, Griff Ø 6 mm, 10.5 cm  
Capsulorhexis Forceps, 12 mm shanks, handle Ø 6 mm, 10.5 cm  
Pinza paracapsulorhexis, lados de un largo de 12 mm, mango Ø 6 mm, 10.5 cm  
Pince pour capsulorhexis, branches 12 mm, manche Ø 6 mm, 10.5 cm



### H-6091 Utrata



Kapsulorhexis Pinzette, 11 mm lange Schenkel, Griff Ø 8 mm, 10.5 cm  
Capsulorhexis forceps, 11 mm shanks, handle Ø 8 mm, 10.5 mm  
Pinza para capsulorhexis, lados de un largo de 11 mm, mango Ø 8 mm, 10.5 mm  
Pince pour capsulorhexis, branches 11 mm, manche Ø 8 mm, 10.5 cm



### H-6092 Utrata



Kapsulorhexis Pinzette, runde Spitzen, Griff Ø 8 mm, 10.5 cm  
Capsulorhexis forceps, round tips, handle Ø 8 mm, 10.5 cm  
Pinza para capsulorhexis, puntas redondas, mango Ø 8 mm, 10.5 cm  
Pince pour capsulorhexis, mors ronds, manche Ø 8 mm, 10.5 cm



**H-6038**



Explantationspinzette, 1 x 1 Zähne  
Explantation forceps, 1 x 1 teeth  
Pinza de explantación, 1 x 1 dientes  
Pince à explantation, 1 x 1 dents



1/1

**H-6420**



IOL Schere  
Geriefte unteres Scherblatt verhindert das Herausrutschen der Linse beim Schneiden, sicheres Schneiden durch starke, kräftige und scharfe Scherblätter.  
Blattlänge: 8 mm, Schaftdurchmesser: 1.8 mm

IOL scissors  
Grooves on the lower cutting blade guarantees no sliding effect while cutting the lens, secure cutting thanks to strong and sharp blades.  
Blade length: 8 mm, diameter of the shaft: 1.8 mm

Tijera IOL  
Las muescas en la hoja inferior evitan el efecto de resbalamiento mientras se corta la lente, corte seguro gracias a las hojas fuertes y agudas.  
Largo de la hoja: 8 mm, diámetro del mango: 1.8 mm  
Ciseaux pour IOL  
Les dentelures sur la lame inférieure suppriment l'effet de glissement pendant la coupe de la lentille.  
Coupe sécurisée grâce aux lames très coupantes.  
Longueur de la lame: 8 mm, Diamètre de la tige: 1.8 mm



1/1



**H-6357**



IOL Faßzange  
Sicheres Fassen der Linse und der Fragmente während des Schnitts im Kapselsack, die Fragmente können dank der speziellen Maulform einfach entfernt werden.  
Maullänge: 11 mm, Schaftdurchmesser: 1.2 mm

IOL forceps  
Secure holding of the lens and the fragments during cutting it inside the capsule sac, fragments can be easily removed thanks to the special shape of the jaws.  
Jaw length: 11 mm, diameter of the shaft: 1.2 mm

Pinza IOL  
Mantiene la lente y los fragmentos seguros mientras se corta en el saco capsular cristalino, gracias a la forma special de la boca los fragmentos se dejan quitar facilmente.  
Largo de la boca: 11 mm, diámetro del mango: 1.2 mm  
Pince pour IOL  
Maintien sûr de la lentille et des fragments au cours de la coupe à l'intérieur du sac capsulaire, les fragments peuvent être facilement enlevés grâce à la forme spéciale des mâchoires.  
Longueur de la mâchoire: 11 mm  
Diamètre de la tige: 1.2 mm



1/1





**H-3280** Linsenimplantationspinzette, 11.5 cm  
 Lens implantation forceps, 11.5 cm  
 Pinza para implantación del cristalino, 11.5 cm  
 Pince pour implantation lentille cristalline, 11.5 cm



**H-3282** **Blaydes**  
 Linsenimplantationspinzette, 11.5 cm  
 Lens implantation forceps, 11.5 cm  
 Pinza para implantación del cristalino, 11.5 cm  
 Pince pour implantation lentille cristalline, 11.5 cm



**H-3283** **Shepard**  
 Linsenimplantationspinzette, 11.5 cm  
 Lens implantation forceps, 11.5 cm  
 Pinza para implantación del cristalino, 11.5 cm  
 Pince pour implantation lentille cristalline, 11.5 cm



**H-3285** **Clayman**  
 Linsenimplantationspinzette, 11.5 cm  
 Lens implantation forceps, 11.5 cm  
 Pinza para implantación del cristalino, 11.5 cm  
 Pince pour implantation lentille cristalline, 11.5 cm



**H-6035** Implantationspinzette, 10.5 cm  
 Implantation forceps, 10.5 cm  
 Pinza para implantación, 10.5 cm  
 Pince pour implantation lentille cristalline, 10.5 cm

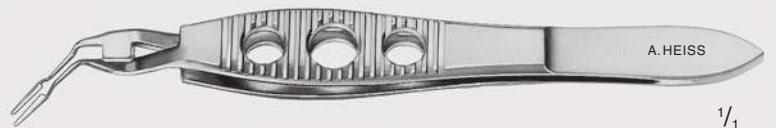

**H-6055** **Steinert**  
 IOL Implantationspinzette, 7 mm konisch geformtes Maul, 10.5 cm  
 IOL Insterting forceps, 7 mm conical shaped jaws, 10.5 cm  
 Pinza para IOL, 7 mm, angulada, 10.5 cm  
 Pince pour IOL, 7 mm, coudée, 10.5 cm



**H-6020 McDonald**  
 Faltpinzette, 10.5 cm  
 Folding forceps, 10.5 cm  
 Pinza para plegar el lente, 10.5 cm  
 Pince pour plier l'implant, 10.5 cm

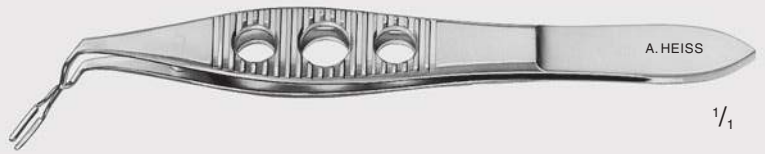

1/1

**H-6025 Linsen-Faltpinzette**, 10.5 cm  
 Lens-folding forceps, 10.5 cm  
 Pinza para plegar el lente, 10.5 cm  
 Pince pour plier l'implant, 10.5 cm



1/1

**H-6030 Livernois**  
 Aufnahme- und Faltpinzette, 10.5 cm  
 Holding and folding forceps, 10.5 cm  
 Pinza para tomar y plegar, 10.5 cm  
 Pince pour saisir et plier l'implant, 10.5 cm

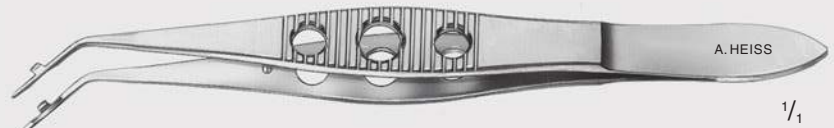

1/1

**H-6060 Gaskin**  
 Fragmentpinzette, abgewinkelt, sehr feine, 11 mm lange Spitzen, 6 mm Griff, 11.5 cm  
 Fragment forceps, angled, very delicate 11 mm long smooth jaws, 6 mm handle, 11.5 cm  
 Pinza de fragmento, angulada, puntas delicadísimas con una plataforma de 11 mm, mango 6 mm, 11.5 cm  
 Pince à fragments, coudée, pointes délicates, plateforme 11mm, manche 6 mm, 11.5 cm



1/1

**H-6061 Gaskin**  
 Fragmentpinzette, abgewinkelt, sehr feine, 11 mm lange Spitzen, 8 mm Griff, 11.5 cm  
 Fragment forceps, angled, very delicate 11 mm long smooth jaws, 8 mm handle, 11.5 cm  
 Pinza de fragmento, angulada, puntas delicadísimas con una plataforma de 11 mm, mango 8 mm, 11.5 cm  
 Pince à fragments, coudée, pointes délicates, 11 mm, manche 8 mm, 11.5 cm



1/1

H-6140

**Gaskin**



Fragmentpinzette, abgewinkelt, sehr feine 11 mm lange Fadenplatte, 10.5 cm  
 Fragment forceps, angled, very delicate 11 mm long smooth jaws, 10.5 cm  
 Pinza de fragmento, angulada, con plataforma de 11 mm delicadísima, 10.5 cm  
 Pince à fragments, coudée, avec plateforme 11 mm très délicate, 10.5 cm



1/1

H-6070

**Dardenne**



Fragmentpinzette, abgewinkelt, sehr feine, 10 mm lange Schenkel, 1 mm lange Spitzen, 10.5 cm  
 Fragment forceps, angled, very delicate 10 mm long delicate shanks, 1 mm long grasping tips, 10.5 cm  
 Pinza de fragmento, angulada, con tallo de 10 mm puntas delicadísimas 1 mm, 10.5 cm  
 Pince à fragments, coudée, branches 10 mm, longueur du mors 1 mm, 10.5 cm



1/1

H-6210

**Kansas**



Fragmentpinzette, abgewinkelt, 10.5 cm  
 Nucleus removal forceps, 10.5 cm  
 Pinza para fragmentos  
 Núcleo de cristalino, 10.5 cm  
 Pince à fragments, coudée, 10.5 cm

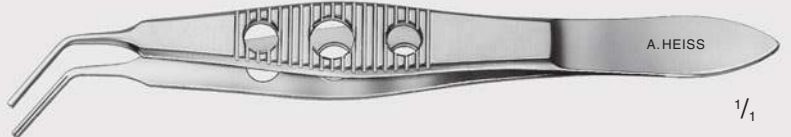

1/1

H-3288A

**Haberle-McPherson**



Linsenhaltepinzette, abgewinkelt mit diagonalen Riefe  
 Lens holding forceps, angled with diagonal groove  
 Pinza para lentes, angulares, con estría diagonal  
 Pince pour IOL, coudée, avec encoche diagonale



1/1

H-6040

**Faulkner**

Linsenpinzette, 11 mm abgewinkelt, 10.5 cm  
 Lens holding forceps, 11 mm angled, 10.5 cm  
 Pinza para lentes, 11 mm angulada, 10.5 cm  
 Pince pour IOL, 11 mm coudée, 10.5 cm

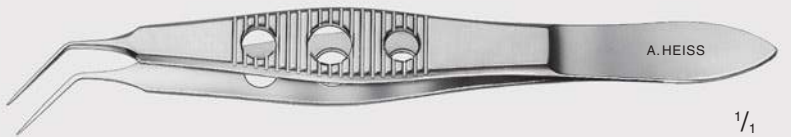

1/1

H-6045

**Osniaka-Faulkner**



Linsenpinzette, abgewinkelt, 10.5 cm  
 Lens holding forceps, angled, 10.5 cm  
 Pinza para sujetar el cristalino, angulada, 10.5 cm  
 Pince pour IOL, coudée, 10.5 cm



1/1

H-6056

**Buratto**



Linsenpinzette, abgewinkelt, 10.5 cm  
 IOL inserter, angled, 10.5 cm  
 Pinza para IOL, angulada, 10.5 cm  
 Pince pour IOL, coudée, 10.5 cm



1/1

**H-6065A Livernois**

Linsenpinzette, gerade, poliertes, rundes Maul, 10.5 cm  
Lens holding forceps, straight, polished round jaws, 10.5 cm  
Pinza para lentes, recta, 10.5 cm  
Pince à implant, droite, mors ronds polis, 10.5 cm



1/1

**H-6065B Livernois**

Linsenpinzette, abgewinkelt, poliertes, rundes Maul, 10.5 cm  
Lens holding forceps, angled, polished round jaws, 10.5 cm  
Pinza para lentes, angulada, 10.5 cm  
Pince à implant, coudée, mors ronds polis, 10.5 cm

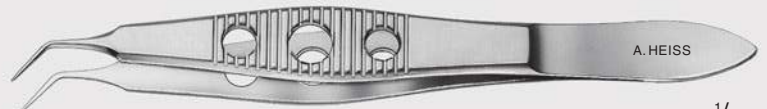

1/1

**H-3342 Barraquer**



Colibri-Fadenlöspinzette  
Colibri forceps for removing sutures  
Colibri pinza para saltar los puntos de sutura  
Pince colibri pour enlever les fils

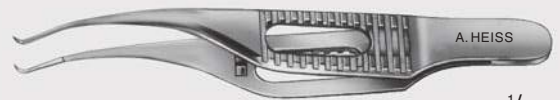

1/1

**H-3332**

Fadenlöspinzette, Juweliers Typ  
Suture removal forceps, jewelers type  
Pinzas para retirar sutura, tipo Joyero  
Pince pour enlever les fils, type joailler



1/1

**H-3337 Barraquer**



Fadenpinzette, gerade, 1 mm, 11cm  
Tying forceps, straight, 1 mm, 11cm  
Pinza para anudar, recta, 1 mm, 11cm  
Pince à fils, sans griffes, droit, 1 mm, 11cm



1/1

**H-3338 Barraquer**



Fadenpinzette, gebogen, 1 mm, 11cm  
Tying forceps, curved, 1 mm, 11cm  
Pinza para anudar, curva, 1 mm, 11cm  
Pince à fils, sans griffes, courbe, 1 mm, 11cm

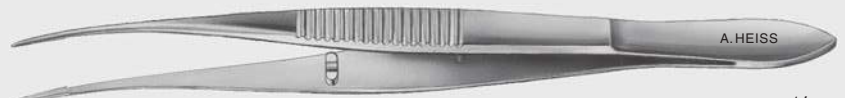

1/1

**H-3288 Kelman-McPherson**



Mikro-Fadenpinzette, abgewinkelt, 7.5 mm, 10.5 cm  
Micro-Tying forceps, angled, 7.5 mm, 10.5 cm  
Micro-Pinza para anudar, acodada, 7.5 mm, 10.5 cm  
Micro-Pince à fils, coudée, 7.5 mm, 10.5 cm



1/1

**H-3347 McPherson**



Mikro-Fadenpinzette, abgewinkelt, ohne Zähne, 0,3 mm, 5 mm Fadenplatte, 8,5 cm  
Micro-Tying forceps, angled, smooth jaws, 0,3 mm, with tying platform 5 mm, 8,5 cm  
Micro-Pinza para anudar, acodada, sin dientes, 0,3 mm, con plataforma 5 mm, 8,5 cm  
Micro-Pince à fils, coudée, sans griffes, 0,3 mm, plateforme 5 mm, 8,5 cm



1/1

**H-3347A McPherson**



Mikro-Fadenpinzette, gerade, ohne Zähne, 0,3 mm, 5 mm Fadenplatte, 8,5 cm  
Micro-tying forceps, straight, smooth jaws, 0,3 mm, with tying platform 5 mm, 8,5 cm  
Micro-pinza para anudar, recta, sin dientes, 0,3 mm, con plataforma 5 mm, 8,5 cm  
Micro-pince à fils, droite, sans griffes, 0,3 mm, plateforme 5 mm, 8,5 cm



1/1

**H-3348 Castroviejo**



Fadenpinzette, gerade 0,5 mm, 7 mm Fadenplatte, 10 cm  
Tying forceps, straight, 0,5 mm, with tying platform 7 mm, 10 cm  
Pinza para anudar, recta, 0,5 mm, con plataforma 7 mm, 10 cm  
Pince à fils, droite 0,5 mm, plateforme 7 mm, 10 cm



1/1

**H-3348A Castroviejo**



Fadenpinzette, gebogen 0,5 mm, 7 mm Fadenplatte, 10 cm  
Tying forceps, curved, 0,5 mm, with tying platform 7 mm, 10 cm  
Pinza para anudar, curva, 0,5 mm, con plataforma 7 mm, 10 cm  
Pince à fils, courbe, 0,5 mm, plateforme 7 mm, 10 cm



1/1

**H-3349A Troutman**



Mikro-Fadenpinzette, gerade, sehr fein, 5 mm Fadenplatte, 9,5 cm  
Micro-Tying forceps, straight, very delicate, with tying platform 5 mm, 9,5 cm  
Micro-Pinza para anudar, recta, muy fina, con plataforma 5 mm, 9,5 cm  
Micro-Pince à fils, droit, très fine, plateforme 5 mm, 9,5 cm



1/1

**H-3349B Troutman**



Mikro-Fadenpinzette, gebogen, sehr fein, 5 mm Fadenplatte, 9,5 cm  
Micro-Tying forceps, curved, very delicate, with tying platform 5 mm, 9,5 cm  
Micro-Pinza para anudar, curva, muy fina, con plataforma 5 mm, 9,5 cm  
Micro-Pince à fils, courbe, très fine, plateforme 5 mm, 9,5 cm



1/1





1/1

**H-3329 Troutman**

Mikro-Fadenpinzette, gerade, sehr fein, 5 mm Fadenplatte, 11.5 cm  
Micro-Tying Forceps, straight, very delicate, with tying platform 5 mm, 11.5 cm  
Micro-Pinza para anudar, recta, muy fina, con plataforma 5 mm, 11.5 cm  
Micro-Pince à fils, droit, très fine, 5 mm, avec plateforme, 11.5 cm



1/1

**H-3329A Troutman**

Mikro-Fadenpinzette, gebogen, sehr fein, 5 mm Fadenplatte, 11.5 cm  
Micro-Tying forceps, curved, very delicate, with tying platform 5 mm, 11.5 cm  
Micro-Pinza para anudar, curva, muy fina, con plataforma 5 mm, 11.5 cm  
Micro-Pince à fils, courbe, très fine, 5 mm, avec plateforme 5 mm, 11.5 cm



1/1

**H-3361 Paufique**

Fadenpinzette, 0,7 mm, mit Fadenplatte, 8 cm  
Tying forceps, 0.7 mm, with tying platform, 8 cm  
Pinza para anudar, 0,7 mm, con plataforma, 8 cm  
Pince à fils, sans griffes, 0,7 mm, avec plateforme, 8 cm



**H-3361A** Fadenpinzette, 0.3 mm, mit Fadenplatte, 8 cm  
Tying forceps, 0.3 mm, with tying platform, 8 cm  
Pinza para anudar, 0.3 mm, con plataforma, 8 cm  
Pince à fils, sans griffes, 0.3 mm, avec plateforme, 8 cm



1/1

**H-6050A Tennant**

Fadenpinzette, gerade, mit Führungsstift, mit sehr feinen Spitzen, 6 mm Fadenplatte, 10 cm  
Tying forceps, straight, with guide pin, extra delicate smooth jaws, 6 mm tying platform, 10 cm  
Pinza para anudar, recta, puntas delicadísimas, plataforma de 6 mm, 10 cm  
Pince à fils, droite, pointes délicates, plateforme 6 mm, 10 cm



1/1

**H-6050B Tennant**

Fadenpinzette, gebogen, mit sehr feinen Spitzen, 6 mm Fadenplatte, 10 cm  
Tying forceps, curved, extra delicate smooth jaws, 6 mm tying platform, 10 cm  
Pinza para anudar, curva, puntas delicadísimas, plataforma de 6 mm, 10 cm  
Pince à fils, courbe, pointes délicates, plateforme 6 mm, 10 cm





**H-6120A McPherson**

Mikro-Fadenpinzette, gerade, 5 mm lange Fadenplatte, 10.5 cm  
Micro-Tying forceps, straight, 5 mm long tying platform, 10.5 cm  
Micro-Pinza para anudar, recta, con plataforma 5 mm, 10.5 cm  
Micro-Pince à fils, droit, plateforme 5 mm, 10.5 cm



**H-6120B McPherson**

Mikro-Fadenpinzette, abgewinkelt, 5 mm lange Fadenplatte, 10.5 cm  
Micro-Tying forceps, angled, 5 mm long tying platform, 10.5 cm  
Micro-Pinza para anudar, angulada, con plataforma 5 mm, 10.5 cm  
Micro-Pince à fils, coudée, plateforme 5 mm, 10.5 cm



**H-6150A Jaffe**

Fadenpinzette, gerade, mit 6 mm Fadenplatte, 10.5 cm  
Tying forceps, straight, with 6 mm tying platform, 10.5 cm  
Pinza para anudar, recta, con plataforma 6 mm, 10.5 cm  
Pince à fils, droit, plateforme 6 mm, 10.5 cm



**H-6150B Jaffe**

Fadenpinzette, gebogen, mit 6 mm Fadenplatte, 10.5 cm  
Tying forceps, curved, with 6 mm tying platform, 10.5 cm  
Pinza para anudar, curva, con plataforma 6 mm, 10.5 cm  
Pince à fils, courbe, plateforme 6 mm, 10.5 cm



**H-6151A Sinskey**

Fadenpinzette, gerade  
Tying forceps, straight  
Pinza para anudar, recta  
Pince à fils, droite



**H-6151B Sinskey**

Fadenpinzette, gebogen  
Tying forceps, curved  
Pinza para anudar, curva  
Pince à fils, courbe





**H-6155 Helveston**  
Fadenpinzette  
Tying forceps  
Pinza para anudar  
Pince à fils



1/1

**H-3359A** Mikro-Fadenpinzette, schwarz, 0.1 mm, 10 cm, mit Fadenplatte  
Micro-Tying forceps, black, 0.1 mm, 10 cm, with tying platform  
Micro-Pinza para anudar, negra, 0.1 mm, 10 cm, con plataforma  
Micro-Pince à fils, 0.1 mm, noir, 10 cm, avec plateforme



1/1

**H-3005** Kanülenpinzette  
Forceps for removal of cannulas  
Pinza para la extracción de cánulas  
Pince pour retrait de canules



1/1

**H-3334/1** Pinzette Juwelier-Typ Nr. 1  
Jewelers forceps No. 1  
Pinza tipo joyero No. 1  
Pince à fils, type joaillier, No. 1



1/1

**H-3334/2** Pinzette Juwelier-Typ Nr. 3c  
Jewelers forceps No. 3c  
Pinza tipo joyero No. 3c  
Pince à fils, type joaillier, No. 3c



1/1

**H-3334/3** Pinzette Juwelier-Typ Nr. 3  
Jewelers forceps No. 3  
Pinza tipo joyero No. 3  
Pince à fils, type joaillier, No. 3



1/1

**H-3334/4** Pinzette Juwelier-Typ Nr. 4  
Jewelers forceps No. 4  
Pinza tipo joyero No. 4  
Pince à fils, type joaillier, No. 4



1/1

**H-3334/5** Pinzette Juwelier-Typ Nr. 5  
Jewelers forceps No. 5  
Pinza tipo joyero No. 5  
Pince à fils, type joaillier, No. 5



1/1

**H-3334/6** Pinzette Juwelier-Typ Nr. 5 – 45  
Jewelers forceps No. 5 – 45  
Pinza tipo joyero No. 5 – 45  
Pince à fils, type joaillier, No. 5 – 45



1/1

**H-3334/7** Pinzette Juwelier-Typ Nr. 7  
Jewelers forceps No. 7  
Pinza tipo joyero No. 7  
Pince à fils, type joaillier, No. 7



1/1

**H-3336** Fadenpinzette, Juweliers Typ, 10.5 cm  
Tying forceps, jewelers type, 10.5 cm  
Pinza para sutura, tipo joyero, 10.5 cm  
Pince à fils, type joaillier, 10.5 cm



1/1

H-3335

**Dastoor**

Nahtpinzette, 1 × 2 Zähne, 0.7 mm, 10 cm  
Suture forceps, 1 × 2 teeth, 0.7 mm, 10 cm  
Pinza para sutura, 1 × 2 dientes, 0.7 mm, 10 cm  
Pince à suture, à 1 × 2 griffes, 0.7 mm, 10 cm



1/1

H-3364

**Jayle**

Nahtpinzette, 1 × 2 Zähne, 0.7 mm, mit Fadenplatte, 11 cm  
Suture forceps, 1 × 2 teeth 0.7 mm, with tying platform, 11 cm  
Pinza para Sutura, 1 × 2 dientes, 0.7 mm, con plataforma, 11 cm  
Pince à suture, à 1 × 2 griffes, 0.7 mm, avec plateforme, 11 cm



1/1

H-3340

**Barraquer**

Nahtpinzette „Colibri“, 1 × 2 Zähne, 0.3 mm, ohne Fadenplatte  
Suture forceps „Colibri“, 1 × 2 teeth, 0.3 mm, without platform  
Pinza para sutura „Colibri“, 1 × 2 dientes, 0.3 mm, sin plataforma  
Pince à suture „Colibri“, à 1 × 2 griffes, 0.3 mm, sans plateforme



1/1

H-3341

**Barraquer**

Mikro-Nahtpinzette „Colibri“, 1 × 2 Zähne, 0.12 mm, ohne Fadenplatte  
Micro-Suture forceps „Colibri“, 1 × 2 teeth, 0.12 mm, without platform  
Micro-Pinza para sutura „Colibri“, 1 × 2 dientes, 0.12 mm, sin plataforma  
Micro-Pince à suture „Colibri“, à 1 × 2 griffes, 0.12 mm, sans plateforme



1/1

H-3345

**Barraquer**

Nahtpinzette „Colibri“, 1 × 2 Zähne, 0.3 mm, mit Fadenplatte  
Suture forceps „Colibri“, 1 × 2 teeth, 0.3 mm, with platform  
Pinza para sutura „Colibri“, 1 × 2 dientes, 0.3 mm, con plataforma  
Pince à suture „Colibri“, à 1 × 2 griffes, 0.3 mm, avec plateforme



1/1

H-3346

**Barraquer**

Mikro-Nahtpinzette „Colibri“, 1 × 2 Zähne, 0.12 mm, mit Fadenplatte  
Micro-Suture forceps „Colibri“, 1 × 2 teeth, 0.12 mm, with platform  
Micro-Pinza para sutura „Colibri“, 1 × 2 dientes, 0.12 mm, con plataforma  
Micro-Pince à suture „Colibri“, à 1 × 2 griffes, 0.12 mm, avec plateforme



1/1

H-3351

**Polack**



Hornhaut Nahtpinzette, U-förmig, 1 × 2 Zähne, 0.12 mm, 7.5 cm  
Corneal suturing forceps, U-shaped, 1 × 2 teeth, 0.12 mm, 7.5 cm  
Pinza para sutura, 1 × 2 dientes, 0.12 mm, 7.5 cm  
Pince à suture pour la cornée, à 1 × 2 griffes, 0.12 mm, 7.5 cm



1/1

H-3350

**Castroviejo**



Nahtpinzette, gerade, 1 × 2 Zähne, 0.9 mm, mit Fadenplatte, 10 cm  
Suture forceps, straight, 1 × 2 teeth, 0.9 mm, with tying platform, 10 cm  
Pinza para sutura, recta, 1 × 2 dientes, 0.9 mm, con plataforma, 10 cm  
Pince à suture, droit, à 1 × 2 griffes, 0.9 mm, avec plateforme, 10 cm

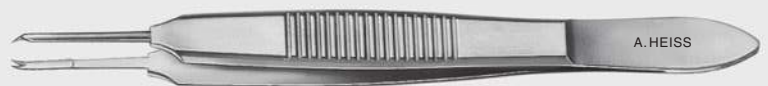

1/1

H-3352

**Castroviejo**

Nahtpinzette, gerade, 1 × 2 Zähne, 0.5 mm, mit Fadenplatte, 10 cm  
Suture forceps, straight, 1 × 2 teeth, 0.5 mm, with tying platform, 10 cm  
Pinza para sutura, recta, 1 × 2 dientes, 0.5 mm, con plataforma, 10 cm  
Pince à suture, droit, à 1 × 2 griffes, 0.5 mm, avec plateforme, 10 cm

H-3354

**Castroviejo**

Nahtpinzette, gerade, 1 × 2 Zähne, 0.12 mm, mit Fadenplatte, 10 cm  
Suture forceps, straight, 1 × 2 teeth, 0.12 mm, with tying platform, 10 cm  
Pinza para sutura, recta, 1 × 2 dientes, 0.12 mm, con plataforma, 10 cm  
Pince à suture, droit, à 1 × 2 griffes, 0.12 mm, avec plateforme, 10 cm

H-3355

**Castroviejo**

Nahtpinzette, gerade, 1 × 2 Zähne, 1.5 mm, mit Fadenplatte, 10 cm  
Suture forceps, straight, 1 × 2 teeth, 1.5 mm, with tying platform, 10 cm  
Pinza para Sutura, recta, 1 × 2 dientes, 1.5 mm, con plataforma, 10 cm  
Pince à suture, droit, à 1 × 2 griffes, 1.5 mm, avec plateforme, 10 cm

H-3356

**Castroviejo**



Nahtpinzette, setilich abgewinkelt, 1 × 2 Zähne, 0.5 mm, mit Fadenplatte, 9 cm  
Suture forceps, angled, 1 × 2 teeth, 0.5 mm with tying platform, 9 cm  
Pinza para sutura, acodada, 1 × 2 dientes, 0.5 mm, con plataforma, 9 cm  
Pince à suture, coudée, à 1 × 2 griffes, 0.5 mm, avec plateforme, 9 cm



1/1



1/1

**H6133A** Castroviejo



Nahtpinzette 1 × 2 Zähne, 0.9 mm, breiter Griff, 10.5 cm  
Suture forceps, 1 × 2 teeth, 0.9 mm, wide handle, 10.5 cm  
Pinza para sutura, 1 × 2 dientes, 0.9 mm, con mango ancho, 10.5 cm  
Pince à suture, à 1 × 2 griffes, 0.9 mm, avec manche nouvelle, manche large, 10.5 cm

**H6133B** Castroviejo

Nahtpinzette, 1 × 2 Zähne, 0.5 mm, breiter Griff, 10.5 cm  
Suture forceps, 1 × 2 teeth, 0.5 mm, wide handle, 10.5 cm  
Pinza para sutura, 1 × 2 dientes, 0.5 mm, con mango ancho, 10.5 cm  
Pince à suture, à 1 × 2 griffes, 0.5 mm, avec manche nouvelle, manche large, 10.5 cm

**H6133C** Castroviejo

Nahtpinzette, 1 × 2 Zähne, 0.3 mm, breiter Griff, 10.5 cm  
Suture forceps, 1 × 2 teeth, 0.3 mm, wide handle, 10.5 cm  
Pinza para sutura, 1 × 2 dientes, 0.3 mm, con mango ancho, 10.5 cm  
Pince à suture, à 1 × 2 griffes, 0.3 mm, avec manche nouvelle, manche large, 10.5 cm

**H6133D** Castroviejo

Nahtpinzette, 1 × 2 Zähne, 0.12 mm, breiter Griff, 10.5 cm  
Suture forceps, 1 × 2 teeth, 0.12 mm, wide handle, 10.5 cm  
Pinza para sutura, 1 × 2 dientes, 0.12 mm, con mango ancho, 10.5 cm  
Pince à suture, à 1 × 2 griffes, 0.12 mm, avec manche nouvelle, manche large, 10.5 cm

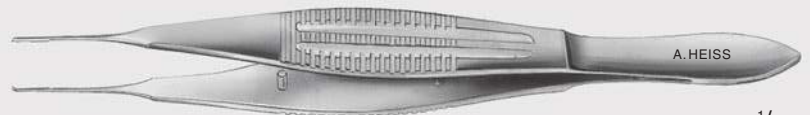

1/1

**H-3357A** Castroviejo



Nahtpinzette 1 × 2 Zähne, 0.9 mm, breiter Griff, 10.5 cm  
Suture forceps, 1 × 2 teeth, 0.9 mm, wide handle, 10.5 cm  
Pinza para sutura, 1 × 2 dientes, 0.9 mm, con mango ancho, 10.5 cm  
Pince à suture, à 1 × 2 griffes, 0.9 mm, avec manche nouvelle, manche large, 10.5 cm

**H-3357B** Castroviejo

Nahtpinzette, 1 × 2 Zähne, 0.5 mm, breiter Griff, 10.5 cm  
Suture forceps, 1 × 2 teeth, 0.5 mm, wide handle, 10.5 cm  
Pinza para sutura, 1 × 2 dientes, 0.5 mm, con mango ancho, 10.5 cm  
Pince à suture, à 1 × 2 griffes, 0.5 mm, avec manche nouvelle, manche large, 10.5 cm

**H-3357C** Castroviejo

Nahtpinzette, 1 × 2 Zähne, 0.3 mm, breiter Griff, 10.5 cm  
Suture forceps, 1 × 2 teeth, 0.3 mm, wide handle, 10.5 cm  
Pinza para sutura, 1 × 2 dientes, 0.3 mm, con mango ancho, 10.5 cm  
Pince à suture, à 1 × 2 griffes, 0.3 mm, avec manche nouvelle, manche large, 10.5 cm

**H-3357D** Castroviejo

Nahtpinzette, 1 × 2 Zähne, 0.12 mm, breiter Griff, 10.5 cm  
Suture forceps, 1 × 2 teeth, 0.12 mm, wide handle, 10.5 cm  
Pinza para Ssre, à 1 × 2 griffes, 0.12 mm, avec manche nouvelle, manche large, 10.5 cm

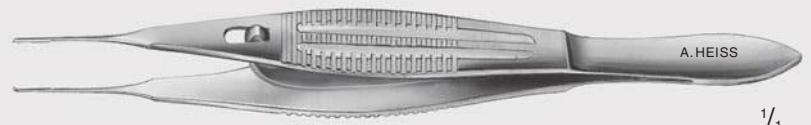

**H-3357BS Stern-Castroviejo**

Nahtpinzette, 1 × 2 Zähne, 0.5 mm, breiter Griff, mit Schloss, 10.5 cm  
Suture forceps, 1 × 2 teeth, 0.5 mm wide handle, with lock, 10.5 cm  
Pinza para sutura, 1 × 2 dientes, 0.5 mm, con mango ancho, con cierre, 10.5 cm  
Pince à suture, à 1 × 2 griffes, 0.5 mm, avec manche nouvelle, manche large, avec ressort, 10.5 cm

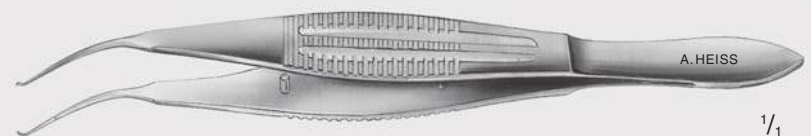

**H-3357DA Castroviejo**

Nahtpinzette, Colibri, 1 × 2 Zähne, 0.12 mm, Fadenplatte, breiter Griff, 10.5 mm  
Suture forceps, Colibri, 1 × 2 teeth, 0.12 mm, with tying platform, wide handle, 10.5 cm  
Pinza para sutura, Colibri, 1 × 2 dientes, 0.12 mm, con mango ancho, 10.5 mm  
Pince à suture, Colibri, à 1 × 2 griffes, 0.12 mm avec manche nouvelle, 10.5 mm



**H-3362 Paufique**

Nahtpinzette, 1 × 2 Zähne, 0.7 mm, 45°, Fadenplatte, 7.5 cm  
Suture forceps, 1 × 2 teeth, 0.7 mm, 45°, tying platform, 7.5 cm  
Pinza para sutura, 1 × 2 dientes, 0.7 mm, 45°, con plataforma, 7.5 cm  
Pince à suture, à 1 × 2 griffes, 0.7 mm, 45°, avec plateforme, 7.5 cm



**H-3362A** Nahtpinzette, 1 × 2 Zähne, 0.3 mm, 45°, Fadenplatte, 8 cm  
Suture forceps, 1 × 2 teeth, 0.3 mm, 45°, tying platform, 8 cm  
Pinza para sutura, 1 × 2 dientes, 0.3 mm, 45°, con plataforma, 8 cm  
Pince à suture, à 1 × 2 griffes, 0.3 mm, 45°, avec plateforme, 8 cm

**H-3362B** Nahtpinzette, 1 × 2 Zähne, 0.12 mm, 45°, Fadenplatte, 8 cm  
Suture forceps, 1 × 2 teeth, 0.12 mm, 45°, tying platform, 8 cm  
Pinza para sutura, 1 × 2 dientes, 0.12 mm, 45°, con plataforma, 8 cm  
Pince à suture, à 1 × 2 griffes, 0.12 mm, 45°, avec plateforme, 8 cm



**H-3359** Mikro-Nahtpinzette, schwarz, 1 × 2 Zähne, 0.1 mm, mit Fadenplatte, 10 cm  
Micro-Suture forceps, black, 1 × 2 teeth, 0.1 mm, with tying platform, 10 cm  
Micro-Pinza para sutura, negra, 1 × 2 dientes, 0.1 mm, con plataforma, 10 cm  
Micro-Pince à suture, noire, à 1 × 2 griffes, 0.1 mm, avec plateforme, 10 cm



**H-3360 St. Martin**  
Nahtpinzette, 1 × 2 Zähne, 0.8 mm, 7.5 cm  
Suture forceps, 1 × 2 teeth, 0.8 mm, 7.5 cm  
Pinza para sutura, 1 × 2 dientes, 0.8 mm, 7.5 cm  
Pince à suture, à 1 × 2 griffes, 0.8 mm, 7.5 cm





1/1

**H-3596**

Nahtpinzette, Modell Zürich „Colibri“, Zähne 0.12 mm, mit Fadenplatte  
Suture forceps, Zurich model “Colibri“, teeth 0.12 mm, with tying platform  
Pinza para sutura, modelo Zürich „Colibri“, dientes 0.12 mm, con plataforma  
Pince à suture, modèle Zürich „Colibri“, griffes 0.12 mm, avec plateforme



1/1

**H-3596A**

Nahtpinzette, Modell Zürich „Colibri“, Zähne 0,12 mm, mit Fadenplatte, abgewinkelt  
Suture forceps, Zurich model “Colibri“, teeth 0.12 mm, with tying platform, angled  
Pinza para sutura, modelo Zürich „Colibri“, dientes 0,12 mm, con plataforma, angulada  
Pince à suture, modèle Zürich „Colibri“, griffes 0,12 mm, avec plateforme, coudée



1/1

**H-3363**

**Sauer**

Nahtpinzette, mit schrägen Zähnen, 8 cm  
Suture forceps, with oblique angled teeth, 8 cm  
Pinza para sutura, con dientes obliquos, 8 cm  
Pince à suture, avec griffes obliques, 8 cm



1/1

**H-3365**

**Dastoor**

Nahtpinzette, 11 cm  
Suture forceps, 11 cm  
Pinza para sutura, 11 cm  
Pince à suture, 11 cm







1/1

**H-6132A McPherson**



Hornhautpinzette, gerade, 1 × 2 Zähne, 0.3 mm, Fadenplatte, 10.5 cm  
Corneal forceps, straight, 1 × 2 teeth, 0.3 mm, tying platform, 10.5 cm  
Pinza para córnea, recta, 1 × 2 dientes, 0.3 mm, con plataforma, 10.5 cm  
Pince pour la cornée, droit, à 1 × 2 griffes, 0.3 mm, avec plateforme, 10.5 cm



1/1

**H-6132B McPherson**



Hornhautpinzette, abgewinkelt, 1 × 2 Zähne, 0.3 mm, Fadenplatte, 10.5 cm  
Corneal forceps, angled, 1 × 2 teeth, 0.3 mm, tying platform, 10.5 cm  
Pinza para córnea, angulada, 1 × 2 dientes, 0.3 mm, con plataforma, 10.5 cm  
Pince pour la cornée, coudée, à 1 × 2 griffes, 0.3 mm, avec plateforme, 10.5 cm



1/1

**H-6170 Kelman-McPherson**



Nahtpinzette, 8 mm, 1 × 2 Zähne, 0.3 mm, 10.5 cm  
Suture forceps, 8 mm, 1 × 2 teeth, 0.3 mm, 10.5 cm  
Pinza para sutura, 8 mm, 1 × 2 dientes, 0.3 mm, 10.5 cm  
Pince à suture, 8 mm, à 1 × 2 griffes, 0.3 mm, 10.5 cm



1/1

**H-6175 Hoffer-McPherson**



Nahtpinzette, 11 mm, 1 × 2 Zähne, 0.12 mm, 10.5 cm  
Suture forceps, 11 mm, 1 × 2 teeth, 0.12 mm, 10.5 cm  
Pinza para sutura, 11 mm, 1 × 2 dientes, 0.12 mm, 10.5 cm  
Pince à suture, 11 mm, à 1 × 2 griffes, 0.12 mm, 10.5 cm



1/1

**H-6131A Hyde**

Hornhautpinzette, Colibri, 2 × 2 Zähne, 0.12 mm, 45° Zähne, 7 mm Fadenplatte  
Corneal forceps, 2 × 2 teeth, 0.12 mm, 45° teeth, tying platform 7 mm  
Pinzas para córnea, 2 × 2 dientes, 0.12 mm, dientes 45°, con plataforma 7 mm  
Micro-Pince pour la cornée, à 2 × 2 griffes, 0.12 mm, griffes 45°, avec plateforme 7 mm

**H-3315 Moehle**

Hornhautpinzette, 9 cm  
Corneal forceps, 9 cm  
Pinza para la córnea, 9 cm  
Pince pour la cornée, 9 cm



1/1

**H-3339 Troutman**



Mikro-Hornhautpinzette, 0.12 mm, 45°, ohne Fadenplatte  
 Micro-Corneal forceps, 0.12 mm, 45°, without tying platform  
 Micro-Pinza para la córnea, 0.12 mm, 45°, sin plataforma  
 Micro-Pince pour la cornée, 0.12 mm, 45°, sans plateforme

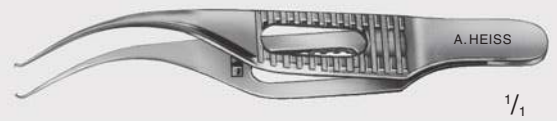

1/1

**H-3339A Troutman**



Mikro-Hornhautpinzette, 0.12 mm, 45°, mit Fadenplatte  
 Micro-Corneal forceps, 0.12 mm, 45°, with tying platform  
 Micro-Pinza para la córnea, 0.12 mm, 45°, con plataforma  
 Micro-Pince pour la cornée, 0.12 mm, 45°, avec plateforme

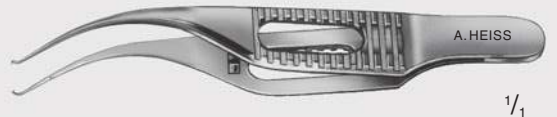

1/1

**H-3344 Pierse-Colibri**



Hornhautpinzette, 1 x 1 Zähne, 0.1 mm  
 Corneal forceps, 1 x 1 teeth, 0.1 mm  
 Pinzas para córnea, 1 x 1 dientes, 0.1 mm  
 Micro-Pince pour la cornée, à 1 x 1 griffes, 0.1 mm



1/1

**H-3375 Pierse**



Mikro-Fixierpinzette, 1 x 1 Zähne, 0.2 mm, 8 cm  
 Micro-Fixation forceps, 1 x 1 teeth, 0.2 mm, 8 cm  
 Micro-Pinza para fijación, 1 x 1 dientes, 0.2 mm, 8 cm  
 Micro-Pince à fixer, à 1 x 1 griffes, 0.2 mm, 8 cm

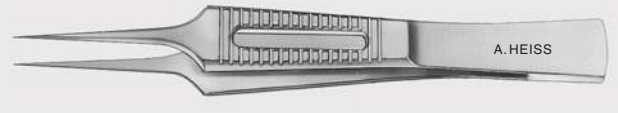

1/1

**H-3376 Pierse**



Mikro-Fixierpinzette, 1 x 1 Zähne, 0.3 mm, 8 cm  
 Micro-Fixation forceps, 1 x 1 teeth, 0.3 mm, 8 cm  
 Micro-Pinza para fijación, 1 x 1 dientes, 0.3 mm, 8 cm  
 Micro-Pince à fixer, à 1 x 1 griffes, 0.3 mm, 8 cm

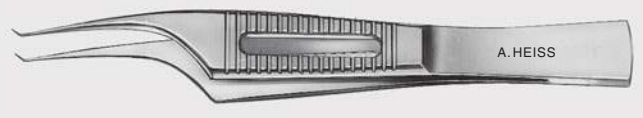

1/1

**H-3377 Pierse**



Mikro-Fixierpinzette, Colibri, 1 x 1 Zähne, 0.2 mm, 8 cm  
 Micro-Fixation forceps, Colibri, 1 x 1 teeth, 0.2 mm, 8 cm  
 Micro-Pinza para fijación, Colibri, 1 x 1 dientes, 0.2 mm, 8 cm  
 Micro-Pince à fixer, Colibri, à 1 x 1 griffes, 0.2 mm, 8 cm

**H-3378 Pierse**



Mikro-Fixierpinzette, Colibri, 1 x 1 Zähne, 0.3 mm, 8 cm  
 Micro-Fixation forceps, Colibri, 1 x 1 teeth, 0.3 mm, 8 cm  
 Micro-Pinza para fijación, Colibri, 1 x 1 dientes, 0.3 mm, 8 cm  
 Micro-Pince à fixer, Colibri, à 1 x 1 griffes, 0.3 mm, 8 cm



**H-6160 Bores**

Hornhautfixierpinzette U-förmig, 1 × 2 Zähne, 0,12 mm, 10,5 cm  
 Corneal fixation forceps U-shaped, 1 × 2 teeth, 0.12 mm, 10.5 cm  
 Pinza de fijación para córnea en forma de U, 1 × 2 dientes, 0,12 mm, 10,5 cm  
 Pince fixation pour cornée en forme de U, à 1 × 2 griffes, 0,12 mm, 10,5 cm

1/1



**H-6130A McPherson**



Hornhautpinzette, gerade, 1 × 2 Zähne, 0,4 mm, Fadenplatte, 10,5 cm  
 Corneal forceps, straight, 1 × 2 teeth, 0.4 mm, tying platform, 10.5 cm  
 Pinza para cornéa, recta, 1 × 2 dientes, 0,4 mm, con plataforma, 10,5 cm  
 Pince pour la cornée, droit, à 1 × 2 griffes, 0,4 mm, avec plateforme, 10,5 cm

1/1



**H-6130B McPherson**



Hornhautpinzette, abgewinkelt, 1 × 2 Zähne, 0,4 mm, Fadenplatte, 10,5 cm  
 Corneal forceps, angled, 1 × 2 teeth, 0.4 mm, tying platform, 10.5 cm  
 Pinza para cornéa, angulada, 1 × 2 dientes, 0,4 mm, con plataforma, 10,5 cm  
 Pince pour la cornée, coudée, à 1 × 2 griffes, 0,4 mm, avec plateforme, 10,5 cm

1/1

**H-3330 Dastoor**

Bindehautpinzette, 11 cm  
 Conjunctival-flap forceps, 11 cm  
 Pinza para conjuntiva, 11 cm  
 Pince pour conjonctive, 11 cm

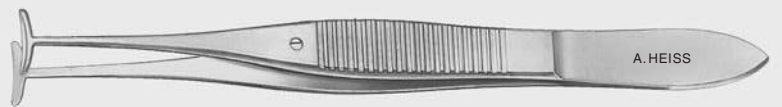

1/1



**H-3370 Moorfield**

Naht und Bindehautpinzette, 10 cm  
 Suture and conjunctival forceps, 10 cm  
 Pinza para sutura y conjuntiva, 10 cm  
 Pince à suture et conjonctive, 10 cm

1/1

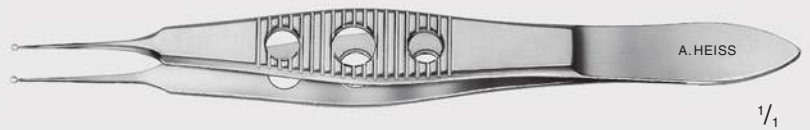

**H-3380 Fechtner**  
 Bindehautpinzette, Ringdurchmesser 1.2 mm, 10.5 cm  
 Conjunctiva forceps, ring diameter 1.2 mm, 10.5 cm  
 Pinzas para conjunctiva, diámetro 1.2 mm, 10.5 cm  
 Pince pour conjonctive, diamètre 1.2 mm, 10.5 cm

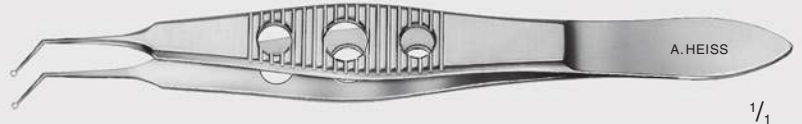

**H-3380A Fechtner**  
 Bindehautpinzette, abgewinkelt, Ringdurchmesser 1.2 mm, 10.5 cm  
 Conjunctiva forceps, angled, ring diameter 1.2 mm, 10.5 cm  
 Pinzas para conjunctiva, angulada, diámetro 1.2 mm, 10.5 cm  
 Pince pour conjonctive, coudée, diamètre 1.2 mm, 10.5 cm



**H-6190A Draeger**  
 LASIK Flap Pinzette, 10.5 cm  
 LASIK Flap forceps, 10.5 cm  
 Pinza para LASIK Flap, 10.5 cm  
 Pince pour LASIK Flap, 10.5 cm



**H-6190 Buratto**  
 LASIK Flap Pinzette, geriefte Spitze, 10.5 cm  
 LASIK Flap forceps, serrated tip, 10.5 cm  
 Pinza para LASIK Flap, puntas estriada-cruz, 10.5 cm  
 Pince pour LASIK Flap, striée, 10.5 cm



**H-6355**  
 DSAEK Pinzette, 0.8 mm, 45° abgewinkelte Plattform  
 DSAEK forceps, 0.8 mm, 45° angled platform  
 Pinza para DSAEK, 0.8 mm, con plataforma angulada (45°)  
 Pince pour DSAEK, 0.8 mm, avec plateforme coudée (45°)



**H-6356**  
 DSAEK Pinzette, 0.8 mm  
 DSAEK forceps, 0.8 mm  
 Pinza para DSAEK, 0.8 mm  
 Pince pour DSAEK, 0.8 mm



**H-3400** **Beaupré**  
 Cilienpinzette, 11,5 cm  
 Cilia forceps, 11,5 cm  
 Pinza para depilación, 11,5 cm  
 Pince à épiler les cils, 11,5 cm



**H-3410** **Henry**  
 Cilienpinzette, 9,5 cm  
 Cilia forceps, 9,5 cm  
 Pinza para depilación, 9,5 cm  
 Pince à épiler les cils, 9,5 cm



**H-3420** **Gradle**  
 Cilienpinzette, 9,5 cm  
 Cilia forceps, 9,5 cm  
 Pinza para depilación, 9,5 cm  
 Pince à épiler les cils, 9,5 cm



**H-3430** **Barraquer**  
 Cilienpinzette, 10,5 cm  
 Cilia forceps, 10,5 cm  
 Pinza para depilación, 10,5 cm  
 Pince à épiler les cils, 10,5 cm

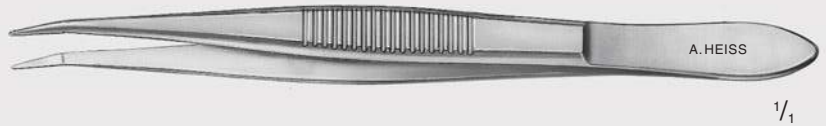

**H-3450** **Beer**  
 Cilienpinzette, 8 cm  
 Cilia forceps, 8 cm  
 Pinza para depilación, 8 cm  
 Pince à épiler les cils, 8 cm

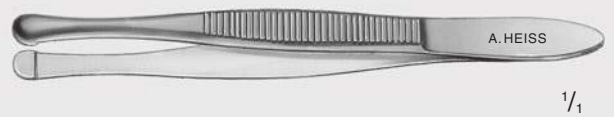

**H-3455** **Ziegler**  
 Cilienpinzette, 9 cm  
 Cilia forceps, 9 cm  
 Pinza para depilación, 9 cm  
 Pince à épiler les cils, 9 cm



**H-3460** **Saupe**  
 Cilienpinzette, 10 cm  
 Cilia forceps, 10 cm  
 Pinza para depilación, 10 cm  
 Pince à épiler les cils, 10 cm



**H-3312** **Watzke**  
 Bandspreizpinzette  
 Sleeve spreading forceps  
 Pinza para extender mangos  
 Pince pour manchon



**H-3313** **Lambert**  
 Bandspreizpinzette  
 Sleeve spreading forceps  
 Pinza para extender mangos  
 Pince pour manchon





**H-6145 Arita**  
Meibom Drüsen-Klemme  
Meibomian gland compressor  
Pinza para las glándulas del Meibomio  
Pince pour les glandes de Meibomius



1/1

**H-2099 Maharaj**  
Meibom Drüsen-Klemme  
Meibomian gland compressor  
Pinza para las glándulas del Meibomio  
Pince pour les glandes de Meibomius



1/1

**H-3595 Schaaf**  
Fremdkörperpinzette, 9.5 cm  
Foreign-Body forceps, 9.5 cm  
Pinza para cuerpos extraños, 9.5 cm  
Pince pour corps étrangers, 9.5 cm



1/1

**H-6300** Vitreoretinal Faßzange, glatt, 20 ga  
Vitreoretinal grasping forceps, smooth, 20 ga  
Pinza para vitreoretinal, plana, 20 ga  
Pince vitréo-rétinienne, mousse, 20 ga



1/1



**H-6310** Vitreoretinal Faßzange, gerieft, 20 ga  
Vitreoretinal grasping forceps, serrated, 20 ga  
Pinza para vitreoretinal, estriada, 20 ga  
Pince vitréo-rétinienne, striée, 20 ga



**H-6320** Vitreoretinal Faßzange, 1 x 2 Zähne, 20 ga  
Vitreoretinal grasping forceps, 1 x 2 teeth, 20 ga  
Pinza para vitreoretinal, dientes 1 x 2, 20 ga  
Pince vitréo-rétinienne, à 1 x 2 griffes, 20 ga



**H-6330** Vitreoretinal Faßzange, 0.3 mm Plattform, 20 ga  
Vitreoretinal grasping forceps, 0.3 mm platform, 20 ga  
Pinza para vitreoretinal, plataforma 0.3 mm, 20 ga  
Pince vitréo-rétinienne, plateforme 0.3 mm, 20 ga



**H-6340** Vitreoretinal Faßzange, glatt, 45°, 20 ga  
Vitreoretinal grasping forceps, smooth, 45°, 20 ga  
Pinza para vitreoretinal, plana, 45°, 20 ga  
Pince vitréo-rétinienne, mousse, 45°, 20 ga



**H-6345** Vitreoretinal Faßzange, glatt, 90°, 20 ga  
Vitreoretinal grasping forceps, smooth, 90°, 20 ga  
Pinza para vitreoretinal, plana, 90°, 20 ga  
Pince vitréo-rétinienne, mousse, 90°, 20 ga





1/1



Vitreoretinal Faßzange  
 Vitreoretinal grasping forceps  
 Pinza para vitreoretinal  
 Pince vitréo-rétinienne

**H-6302**

20 ga, glatt, Titangriff  
 20 ga, smooth, titanium handle  
 20 ga, plana, mango titanio  
 20 ga, mousse, manche titane



**H-6303**

23 ga, glatt, Titangriff  
 23 ga, smooth, titanium handle  
 23 ga, plana, mango titanio  
 23 ga, mousse, manche titane



**H-6312**

20 ga, gerieft, Titangriff  
 20 ga, serrated, titanium handle  
 20 ga, estriada, mango titanio  
 20 ga, striée, manche titane



**H-6313**

23 ga, gerieft, Titangriff  
 23 ga, serrated, titanium handle  
 23 ga, estriada, mango titanio  
 23 ga, striée, manche titane



**H-6322**

20 ga, 1 × 2 Zähne, Titangriff  
 20 ga, 1 × 2 teeth, titanium handle  
 20 ga, dientes 1 × 2, mango Titanio  
 20 ga, 1 × 2 griffes, manche titane



**H-6331**

20 ga, 0.1 mm Plattform, Titangriff  
 20 ga, 0.1 mm platform, titanium handle  
 20 ga, plataforma 0.1 mm, mango titanio  
 20 ga, plateforme 0.1 mm, manche titane



**H-6338**

23 ga, 0.1 mm Plattform, Titangriff  
 23 ga, 0.1 mm platform, titanium handle  
 23 ga, plataforma 0.1 mm, mango titanio  
 23 ga, plateforme 0.1 mm, manche titane



**H-6332**

20 ga, 0.3 mm Plattform, Titangriff  
 20 ga, 0.3 mm platform, titanium handle  
 20 ga, plataforma 0.3 mm, mango titanio  
 20 ga, plateforme 0.3 mm, manche titane



**H-6333**

23 ga, 0.3 mm Plattform, Titangriff  
 23 ga, 0.3 mm platform, titanium handle  
 23 ga, plataforma 0.3 mm, mango titanio  
 23 ga, plateforme 0.3 mm, manche titane



**H-6342**

20 ga, glatt, 45°, Titangriff  
 20 ga, smooth, 45°, titanium handle  
 20 ga, plana, 45°, mango titanio  
 20 ga, mousse, 45°, manche titane



**H-6347**

20 ga, glatt, 90°, Titangriff  
 20 ga, smooth, 90°, titanium handle  
 20 ga, plana, 90°, mango titanio  
 20 ga, mousse, 90°, manche titane



**H-6339**

23 ga, ILM Pinzette, Titangriff  
 23 ga, ILM Forceps, titanium handle  
 23 ga, pinza para ILM, mango titanio  
 23 ga, pince pour ILM, manche titane





**H-3901 Ayer**  
 Chalazionspinzette, 8 mm, 9 cm  
 Chalazion forceps, 8 mm, 9 cm  
 Pinza de chalazion, 8 mm, 9 cm  
 Pince à chalazion, 8 mm, 9 cm



**H-3910 Lambert**  
 Chalazionspinzette, 8 mm, 9 cm  
 Chalazion forceps, 8 mm, 9 cm  
 Pinza de chalazion, 8 mm, 9 cm  
 Pince à chalazion, 8 mm, 9 cm



**H-3910A Lambert**  
 Chalazionspinzette, 15 mm, 9 cm  
 Chalazion forceps, 15 mm, 9 cm  
 Pinza de chalazion, 15 mm, 9 cm  
 Pince à chalazion, 15 mm, 9 cm

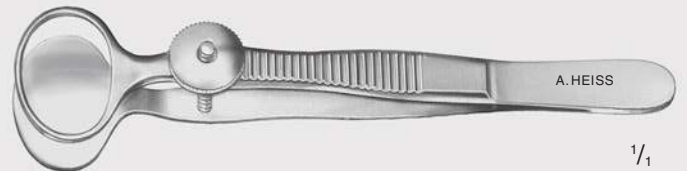

**H-3920/1 Desmarres**  
 Chalazionspinzette, 20 mm, 9 cm  
 Chalazion forceps, 20 mm, 9 cm  
 Pinza de chalazion, 20 mm, 9 cm  
 Pince à chalazion, 20 mm, 9 cm

**H-3920/2**  
 26 mm  
 26 mm  
 26 mm  
 26 mm

**H-3920/3**  
 31 mm  
 31 mm  
 31 mm  
 31 mm

**H-3930 Cauer**  
 Chalazionspinzette, I.D. 12 × 14 mm, 10 cm  
 Chalazion forceps, I.D. 12 × 14 mm, 10 cm  
 Pinza de chalazion, diámetro interior 12 × 14 mm, 10 cm  
 Pince à chalazion, diamètre intérieur 12 × 14 mm, 10 cm



**H-3935 Lordan**  
 Chalazionspinzette, 10 cm  
 Chalazion forceps, 10 cm  
 Pinza de chalazion, 10 cm  
 Pince à chalazion, 10 cm



**H-3940 Hunt**  
 Chalazionspinzette, I.D. 12 mm, 10 cm  
 Chalazion forceps, I.D. 12 mm, 10 cm  
 Pinza de chalazion, diámetro interior 12 mm, 10 cm  
 Pince à chalazion, diamètre intérieur 12 mm, 10 cm



**H-3915 Francis**

Chalazionspinzette I.D. 8 × 14 mm, 9 cm  
 Chalazion forceps I.D. 8 × 14 mm, 9 cm  
 Pinza de chalazion, diámetro interior 8 × 14 mm, 9 cm  
 Pince à chalazion, diamètre intérieur 8 × 14 mm, 9 cm



1/1

**H-3916 Baird**

Chalazionspinzette I.D. 8 × 11 mm  
 Chalazion forceps I.D. 8 × 11 mm  
 Pinza de chalazion, diámetro interior 8 × 11 mm  
 Pince à chalazion, diamètre intérieur 8 × 11 mm

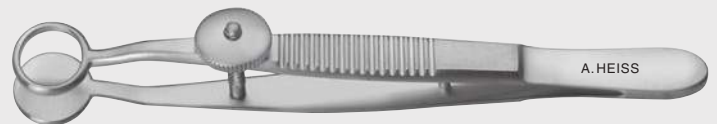

1/1

**H-3950 Erhardt**

Lidpinzette, 9.5 cm  
 Lid forceps, 9.5 cm  
 Pinza para párpados, 9.5 mm  
 Pince de paupières, 9.5 cm



1/1

**H-3200 Graefe**

Fixierpinzette, ohne Schloss, 11 cm  
 Fixation forceps, without lock, 11 cm  
 Pinza de fijación, sin muelle, 11 cm  
 Pince à fixer, sans ressort, 11 cm



1/1

**H-3201 Graefe**

Fixierpinzette, mit Schloss, 11 cm  
 Fixation forceps, with lock, 11 cm  
 Pinza de fijación, con muelle, 11 cm  
 Pince à fixer, avec ressort, 11 cm



1/1

**H-3205 Panas**

Fixierpinzette, Maul konkav, 11 cm  
 Fixation forceps, jaw concav, 11 cm  
 Pinza de fijación, boca cóncava, 11 cm  
 Pince à fixer, mors concaves, 11 cm



1/1

**H-3245** **Elschnig**  
 Fixierpinzette, 10 cm  
 Fixation forceps, 10 cm  
 Pinza de fijación, 10 cm  
 Pince à fixer, 10 cm



**H-3255** **Green**  
 Fixierpinzette, 10 cm  
 Fixation forceps, 10 cm  
 Pinza de fijación, 10 cm  
 Pince à fixer, 10 cm



**H-3260**  
 Fixierpinzette, 1 x 2 Zähne, 11.5 cm  
 Fixation forceps, 1 x 2 teeth, 11.5 cm  
 Pinza de fijación, 1 x 2 dientes, 11.5 cm  
 Pince à fixer, à 1 x 2 griffes, 11.5 cm



**Moody**  
 Fixierpinzette, 1 x 2 Zähne, 0.5 mm, mit Schloss  
 Fixation forceps, 1 x 2 teeth, 0.5 mm, with lock  
 Pinza para fijación, 1 x 2 dientes, 0.5 mm, con muelle  
 Pince à fixer, à 1 x 2 griffes, 0.5 mm, avec ressort



**H-6165** links  
 left  
 izquierda  
 gauche

**H-6166** rechts  
 right  
 derecha  
 droit

**H-3290** **Lester**  
 Fixierpinzette, 1 x 2 Zähne, 9 cm  
 Fixation forceps, 1 x 2 teeth, 9 cm  
 Pinza de fijación, 1 x 2 dientes, 9 cm  
 Pince à fixer, à 1 x 2 griffes, 9 cm

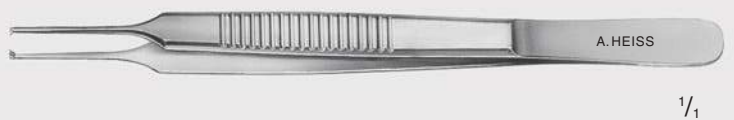

**H-3292** **Lester**  
 Fixierpinzette, 2 x 3 Zähne, 9 cm  
 Fixation forceps, 2 x 3 teeth, 9 cm  
 Pinza de fijación, 2 x 3 dientes, 9 cm  
 Pince à fixer, à 2 x 3 griffes, 9 cm



**H-3300** Castroviejo

Fixierpinzette, gerade, 1 × 1 Zähne, 9 cm  
Fixation forceps, straight, 1 × 1 teeth, 9 cm  
Pinza de fijación, recta, 1 × 1 dientes, 9 cm  
Pince à fixer, droit, à 1 × 1 griffes, 9 cm



1/1

**H-3310** Castroviejo

Fixierpinzette, abgewinkelt, 1 × 1 Zähne, 9 cm  
Fixation forceps, angled, 1 × 1 teeth, 9 cm  
Pinza de fijación, acodada, 1 × 1 dientes, 9 cm  
Pince à fixer, coudée, à 1 × 1 griffes, 9 cm



1/1

**H-3474** Kirby

Fixierpinzette 1 × 2 Zähne, mit Schieber, 10 cm  
Fixation forceps, 1 × 2 teeth, with slide catch, 10 cm  
Pinza para fijación, 1 × 2 dientes, con fiador, 10 cm  
Pince à fixer, à 1 × 2 griffes, avec verrou, 10 cm



1/1

**H-3742** Bangerter

Muskelklemme, selbsthaltend  
Muscle clamp, self retaining  
Pinza clamp muscular  
Pince musculaire



1/1

**H-3295 Dastoor**  
Muskelpinzette, 1 × 2 Zähne, 9 cm  
Superior rectus forceps, 1 × 2 teeth, 9 cm  
Pinza para estrabismo, 1 × 2 dientes, 9 cm  
Pince à strabisme, à 1 × 2 griffes, 9 cm



**H-3298 Troutman**  
Muskelpinzette, 1 × 2 Zähne, 9 cm  
Superior rectus forceps, 1 × 2 teeth, 9 cm  
Pinza para fijación recto superior, 1 × 2 dientes, 9 cm  
Pince à strabisme, à 1 × 2 griffes, 9 cm



**H-3465 Remky**  
Zügelnahtpinzette, 1 × 2 Zähne, 9 cm  
Superior rectus forceps, 1 × 2 teeth, 9 cm  
Pinza para superior rectus, angulada, 1 × 2 dientes, 9 cm  
Pince à mors croisée, à 1 × 2 griffes, 9 cm



**H-3960 Downes**  
Lidklemme  
Lid clamp  
Pinca para párpados  
Pince de paupières



**Berke**  
Muskelpinzette für Ptosis, 10.5 cm  
Ptosis clamp, 10.5 cm  
Pinza muscular para ptosis, 10.5 cm  
Pince musculaire pour ptosis, 10.5 cm



**H-3820** 20 mm

**H-3821** 27 mm

**Snellen**  
Entropionpinzette, 9.5 cm  
Entropium forceps, 9.5 cm  
Pinza para entropión, 9.5 cm  
Pince à entropion, 9.5 cm

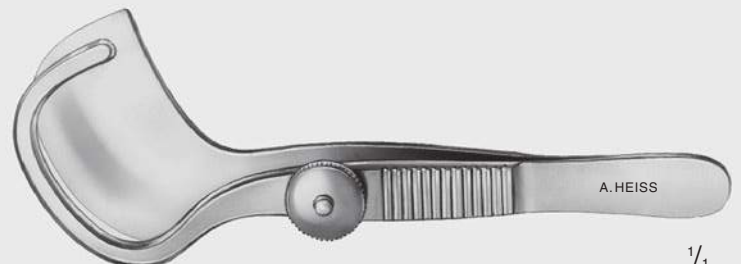

**H-3851** links : izquierda  
left : à gauche

**H-3850** rechts : derecha  
right : à droit

**H-3955**

**Putterman**

Klemme mit 6 Pins  
Forceps and clamp with 6 pins  
Pinza con 6 pins, para cirugía plástica del párpado  
Pince avec 6 broches



**Jameson**

Vorlagerungspinzette, 14 mm  
Advancement forceps, 14 mm  
Pinza para avanzamiento muscular, 14 mm  
Pince pour avancement musculaire, 14 mm

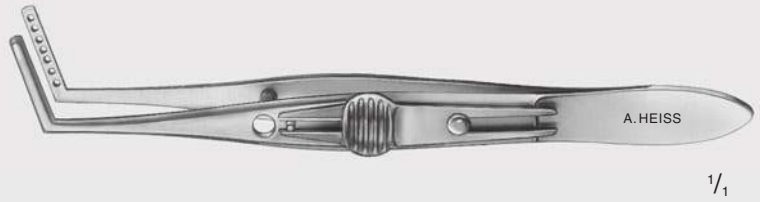

**H-3721**

links ..... izquierda  
left ..... à gauche

**H-3720**

rechts ..... derecha  
right ..... à droit

**Jameson**

Vorlagerungspinzette, 10 mm  
Advancement forceps, 10 mm  
Pinza para avanzamiento muscular, 10 mm  
Pince pour avancement musculaire, 10 mm

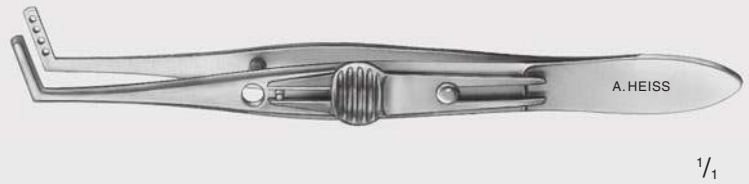

**H-3721S**

links ..... izquierda  
left ..... à gauche

**H-3720S**

rechts ..... derecha  
right ..... à droit

### Hartmann

Klemme, 10 cm  
Haemostatic forceps, 10 cm  
Pinza hemostática, 10 cm  
Pince hémostatique, 10 cm

H-2700 gerade recta  
straight droite

H-2701 gebogen curva  
curved courbe

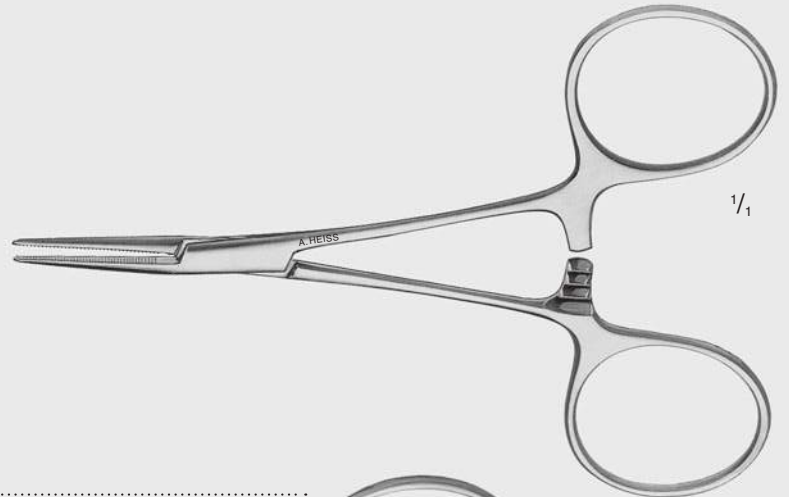

### Halstead-Mosquito

Klemme, 12 cm  
Haemostatic forceps, 12 cm  
Pinza hemostática, 12 cm  
Pince hémostatique, 12 cm

H-2720 gerade recta  
straight droite

H-2725 gebogen curva  
curved courbe

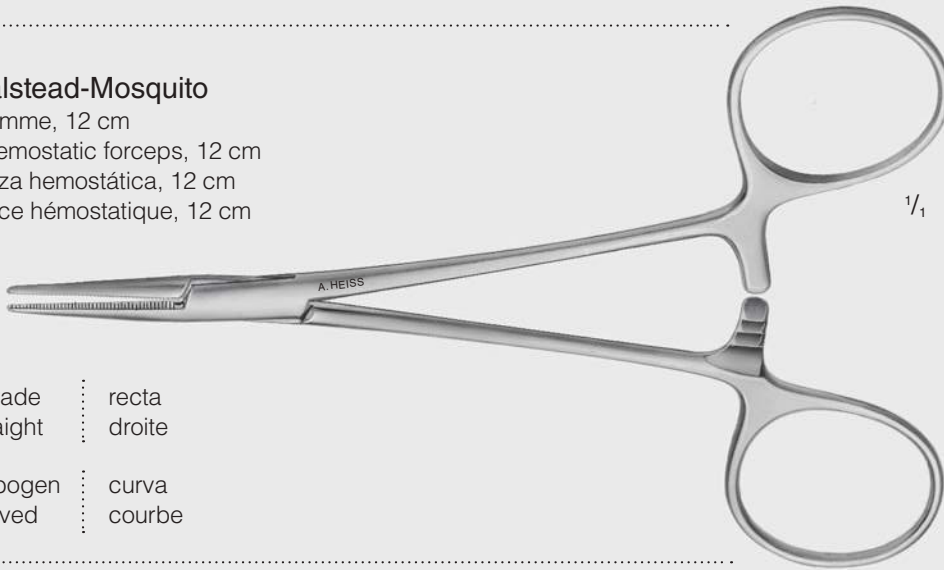

H-2730 Backhaus  
Tuchklemme, 8 cm  
Towel forceps, 8 cm  
Pinza para compresas, 8 cm  
Pince à compresses, 8 cm

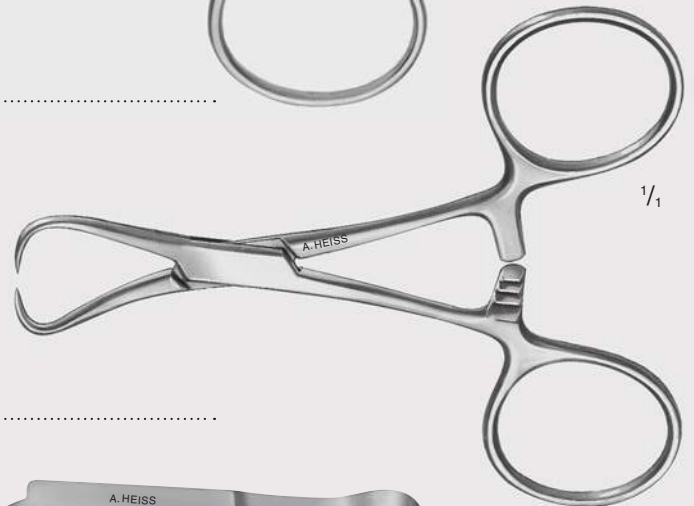

H-2732 Jones  
Tuchklemme  
Towel forceps  
Pinza para compresas  
Pince à compresses



H-2755 Dieffenbach  
Gefäßklemme, gerade, 3.5 cm  
Serrefine, straight, 3.5 cm  
Serra-fina, recta, 3.5 cm  
Serre-fine, droite, 3.5 cm



H-2756 Dieffenbach  
Gefäßklemme, gebogen, 3.5 cm  
Serrefine, curved, 3.5 cm  
Serra-fina, curva, 3.5 cm  
Serre-fine, courbe, 3.5 cm



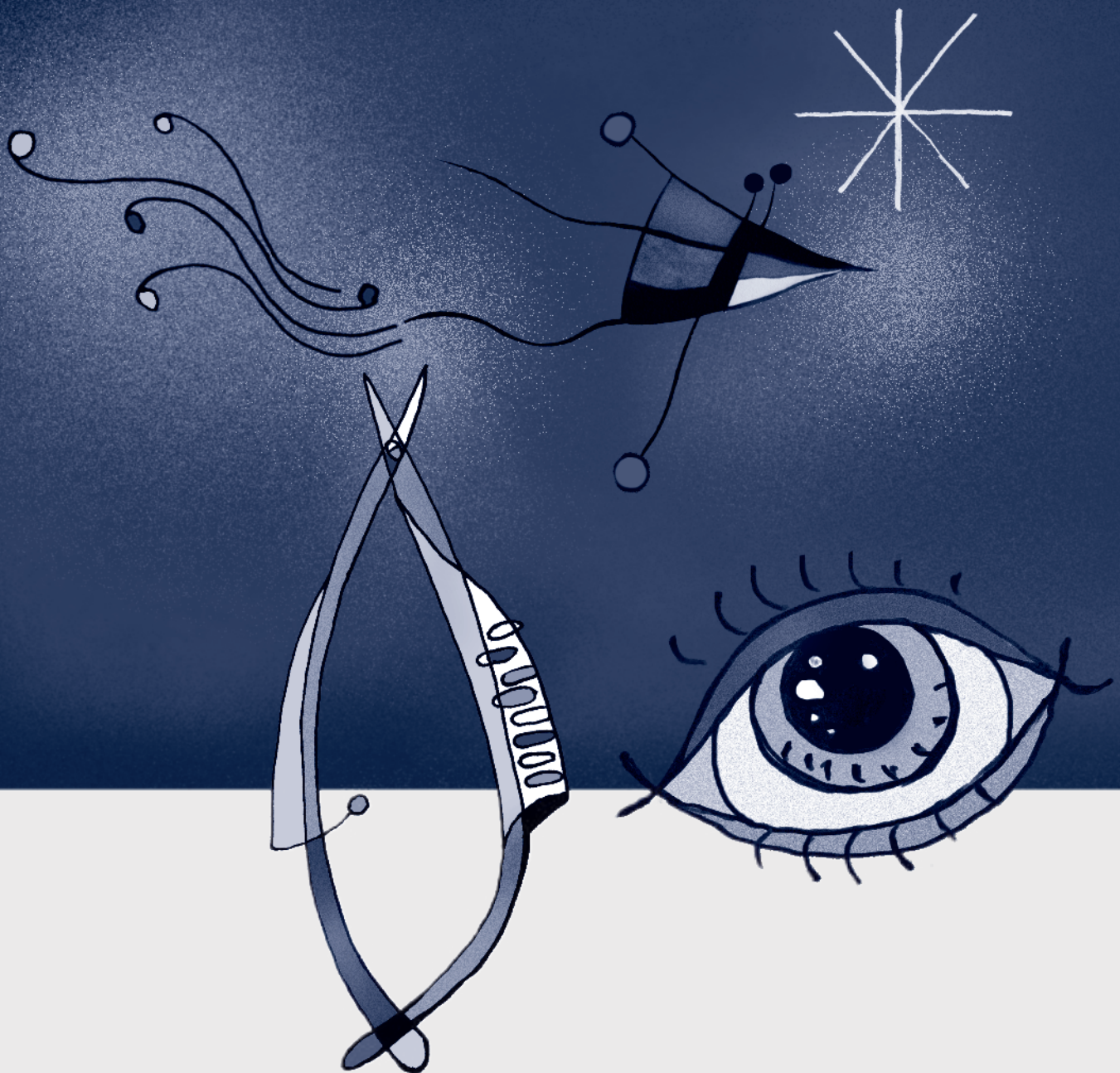

5

..... Scheren  
..... Scissors  
..... Tijeras  
..... Ciseaux  
.....

**H-4200A Wecker**

Iridektomieschere, spitz/spitz, Fig. A  
Iris scissors, pointed/pointed, fig. A  
Pinza-tijera para iridectomia, aguda/aguda, fig. A  
Pince-ciseaux à iridectomie, pointus/pointus, fig. A

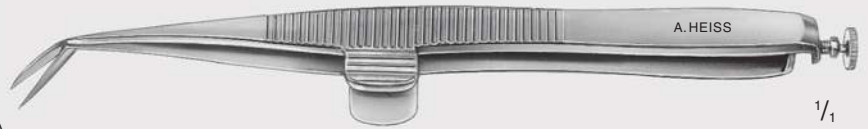

1/1

**H-4200B Wecker**

Iridektomieschere, spitz/stumpf, Fig. B  
Iris scissors, pointed/blunt, fig. B  
Pinza-tijera para iridectomia, aguda/roma, fig. B  
Pince-ciseaux à iridectomie, pointus/mousse, fig. B



1/1

**H-4200C Wecker**

Iridektomieschere, stumpf/stumpf, Fig. C  
Iris scissors, blunt/blunt, fig. C  
Pinza-tijera para iridectomia, roma/roma, fig. C  
Pince-ciseaux à iridectomie, mousse/mousse, fig. C



1/1

**H-4210/1 Noyes**

Iridektomieschere, spitz/spitz, Fig. 1  
Iris scissors, pointed/pointed, fig. 1  
Pinza-tijera para iridectomia, aguda/aguda, fig. 1  
Pince-ciseaux à iridectomie, pointus/pointus, fig. 1



1/1

**H-4210/2 Noyes**

Iridektomieschere, spitz/stumpf, Fig. 2  
Iris scissors, pointed/blunt, fig. 2  
Pinza-tijera para iridectomia, aguda/roma, fig. 2  
Pince-ciseaux à iridectomie, pointus/mousse, fig. 2



1/1

**H-4210/3 Noyes**

Iridektomieschere, stumpf/stumpf, Fig. 3  
Iris scissors, blunt/blunt, fig. 3  
Pinza-tijera para iridectomia, roma/roma, fig. 3  
Pince-ciseaux à iridectomie, mousse/mousse, fig. 3



1/1

**H-4220 Barraquer**

Iridektomieschere, Blattlänge 7 mm  
Iris scissors, 7 mm blade  
Pinza-tijera para iridectomia, hojas 7 mm de largo  
Pince-ciseaux à iridectomie, lames 7 mm de long



1/1

**H-4225 Barraquer**

Iridektomieschere, Blattlänge 10 mm  
Iris scissors, 10 mm blade  
Pinza-tijera para iridectomia, hojas 10 mm de largo  
Pince-ciseaux à iridectomie, lames 10 mm de long



1/1

**H-4260 Castroviejo**

Irisschere, spitz, gebogen, 9.5 cm  
Iris scissors, pointed, curved, 9.5 cm  
Pinza-tijera para iridectomia, aguda, curva, 9.5 cm  
Pince-ciseaux á iridectomie, pointus, courbes, 9.5 cm



1/1



**H-4240 Vannas**

Mikro-Nachstarschere, gerade, sehr fein, Blattlänge 7 mm, 8 cm  
Micro-scissors, secondaire cataract, straight, very delicate, blade 7 mm, 8 cm  
Micro-tijera para cataracta secundaria, recta, fina, hojas 7 mm de largo, 8 cm  
Micro-ciseaux pour cataracte secondaire, droits, fins, lames 7 mm, 8 cm



**H-4240B Vannas**

Mikro-Nachstarschere, gerade, sehr fein, stumpf, Blattlänge 7 mm, 8 cm  
Micro-scissors, secondaire cataract, straight, blunt, very delicate, blade 7 mm, 8 cm  
Micro-tijera para cataracta secundaria, recta, fina, roma, hojas 7 mm de largo, 8 cm  
Micro-ciseaux pour cataracte secondaire, droits, fins, mousse, lames 7 mm, 8 cm



**H-4241 Vannas**

Mikro-Nachstarschere, gebogen, sehr fein, Blattlänge 7 mm, 8 cm  
Micro-scissors, secondaire cataract, curved, very delicate, blade 7 mm, 8 cm  
Micro-tijera para cataracta secundaria, curva, fina, hojas 7 mm de largo, 8 cm  
Micro-ciseaux pour cataracte secondaire, courbes, fins, lames 7 mm, 8 cm



**H-4241B Vannas**

Mikro-Nachstarschere, gebogen, sehr fein, stumpf, Blattlänge 7 mm, 8 cm  
Micro-scissors, secondaire cataract, curved, very delicate, blunt, blade 7 mm, 8 cm  
Micro-tijera para cataracta secundaria, curva, fina, roma, hojas 7 mm de largo, 8 cm  
Micro-ciseaux pour cataracte secondaire, courbes, fins, mousse, lames 7 mm, 8 cm



**H-4242 Vannas**

Mikro-Nachstarschere, abgewinkelt, sehr fein, Blattlänge 7 mm, 8 cm  
Micro-scissors, secondaire cataract, angled, very delicate, blade 7 mm, 8 cm  
Micro-tijera para cataracta secundaria, angulada, fina, hojas 7 mm de largo, 8 cm  
Micro-ciseaux pour cataracte secondaire, anglés, lames 7 mm, 8 cm





**H-4243 Vannas**

Mikro-Nachstarschere, kniegebogen, sehr fein, Blattlänge 7 mm, 8 cm  
 Micro-scissors, secondaire cataract, angled, very delicate, blade 7 mm, 8 cm  
 Micro-tijera para cataracta secundaria, cangulada, fina, hojas 7 mm de largo, 8 cm  
 Micro-ciseaux pour cataracte secondaire, coudée, fins, lames 7 mm, 8 cm



**H-4245 Uthoff**

Kapselschere, konvex gebogene Blätter, Blattlänge 10 mm, 8.5 cm  
 Capsule scissors, convex curved blades, blade 10 mm, 8.5 cm  
 Tijera para cápsula, curva convexa, hojas 10 mm de largo, 8.5 cm  
 Ciseaux capsulaires, courbe-convexe, lames 10 mm, 8.5 cm



**H-4246 Ong**

Kapselschere, nach oben abgewinkelt, Blattlänge 11 mm, 8.5 cm  
 Capsule scissors, angled forward, blade 11 mm, 8.5 cm  
 Tijera para cápsula, angulada hacia arriba, hojas 11 mm de largo, 8.5 cm  
 Ciseaux capsulaires, en angle vers le haut, lames 11 mm, 8.5 cm



**H-4247 Vannas**

Mikro-Nachstarschere, Modell Tübingen, gerade, sehr fein, Blattlänge 11 mm, 8.5 cm  
Micro-scissors, secondaire cataract, straight, Tübingen model, very delicate, blade 11 mm, 8.5 cm  
Micro-tijera para catarata secundaria, recta Modelo Tübingen, fina, hojas 11 mm de largo, 8.5 cm  
Micro-ciseaux pour cataracte secondaire, modèle Tübingen, droits, fins, lames 11 mm, 8.5 cm



**H-4247B Vannas**

Mikro-Nachstarschere, Modell Tübingen, gerade, sehr fein, stumpf, Blattlänge 11 mm, 8.5 cm  
Micro-scissors, secondaire cataract, straight, Tübingen model, very delicate, blunt, blade 11 mm, 8.5 cm  
Micro-tijera para catarata secundaria, recta Modelo Tübingen, fina, roma, hojas 11 mm de largo, 8.5 cm  
Micro-ciseaux pour cataracte secondaire, modèle Tübingen, droits, fins, mousse, lames 11 mm, 8.5 cm



**H-4247A Vannas**

Mikro-Nachstarschere, Modell Tübingen, gebogen, sehr fein, Blattlänge 11 mm, 8.5 cm  
Micro-scissors, secondaire cataract, curved, Tübingen model, very delicate, blade 11 mm, 8.5 cm  
Micro-tijera para catarata secundaria, curva, Modelo Tübingen, fina, hojas 11 mm de largo, 8.5 cm  
Micro-ciseaux pour cataracte secondaire, modèle Tübingen, courbe, fins, lames 11 mm, 8.5 cm



**H-4247AB Vannas**

Mikro-Nachstarschere, Modell Tübingen, gebogen, sehr fein, stumpf, Blattlänge 11 mm, 8.5 cm  
Micro-scissors, secondaire cataract, curved, Tübingen model, very delicate, blunt, blade 11 mm, 8.5 cm  
Micro-tijera para catarata secundaria, curva, Modelo Tübingen, fina, roma, hojas 11 mm de largo, 8.5 cm  
Micro-ciseaux pour cataracte secondaire, modèle Tübingen, courbe, fins, mousse, lames 11 mm, 8.5 cm



1/1



**H-6420**

IOL Schere

Gerieftes unteres Scherblatt verhindert das Herausrutschen der Linse beim Schneiden, sicheres Schneiden durch starke, kräftige und scharfe Scherblätter.  
 Blattlänge: 8 mm, Schaftdurchmesser: 1.8 mm

IOL scissors

Grooves on the lower cutting blade guarantees no sliding effect while cutting the lens, secure cutting thanks to strong and sharp blades.  
 Blade length: 8 mm, diameter of the shaft: 1.8 mm

Tijera IOL

Las muescas en la hoja inferior evitan el efecto de resbalamiento mientras se corta la lente, corte seguro gracias a las hojas fuertes y agudas.  
 Largo de la hoja: 8 mm, diámetro del mango: 1.8 mm

Ciseaux pour IOL

Les dentelures sur la lame inférieure suppriment l'effet de glissement pendant la coupe de la lentille.  
 Coupe sécurisée grâce aux lames très coupantes.  
 Longueur de la lame: 8 mm, diamètre de la tige: 1.8 mm



1/1



**H-6357**

IOL Faßzange

Sicheres Fassen der Linse und der Fragmente während des Schnitts im Kapselsack, die Fragmente können dank der speziellen Maulform einfach entfernt werden.  
 Maullänge: 11 mm, Schaftdurchmesser: 1.2 mm

IOL forceps

Secure holding of the lens and the fragments during cutting it inside the capsule sac, fragments can be easily removed thanks to the special shape of the jaws.  
 Jaw length: 11 mm, diameter of the shaft: 1.2 mm

Pinza IOL

Mantiene la lente y los fragmentos seguros mientras se corta en el saco capsular cristalino, gracias a la forma special de la boca los fragmentos se dejan quitar facilmente.  
 Largo de la boca: 11 mm, diámetro del mango: 1.2 mm

Pince pour IOL

Maintien sûr de la lentille et des fragments au cours de la coupe à l'intérieur du sac capsulaire, les fragments peuvent être facilement enlevés grâce à la forme spéciale des mâchoires.  
 Longueur de la mâchoire: 11 mm  
 Diamètre de la tige: 1.2 mm



**H-6038**



Explantationpinzette, 1 x 1 Zähne  
 Explantation forceps, 1 x 1 teeth  
 Pinza de explantación, 1 x 1 dientes  
 Pince à explantation, 1 x 1 dents



1/1

**H-4294**



IOL Schere, gerades Scherblatt  
 Gerieftes unteres Scherblatt verhindert das Herausrutschen der Linse beim Schneiden.  
 Sicheres Schneiden durch starke, kräftige und scharfe Scherblätter.  
 IOL Scissors, straight blades  
 Grooves on the lower cutting blade guarantees no sliding effect while cutting the lens .  
 Secure cutting thanks to strong and sharp blades.  
 Tijera para IOL, hojas rectas  
 Las muescas en la hoja inferior evitan el efecto de resbalamiento mientras se corta la lente.  
 Corte seguro gracias a las hojas fuertes y agudas.  
 Ciseaux pour IOL, lames droites  
 Les dentelures sur la lame inférieure suppriment l'effet de glissement pendant la coupe de la lentille.  
 Coupe sécurisée grâce aux lames très coupantes.



1/1

**H-4295**



IOL Schere, gerades Scherblatt, abgewinkelt  
 Gerieftes unteres Scherblatt verhindert das Herausrutschen der Linse beim Schneiden.  
 Sicheres Schneiden durch starke, kräftige und scharfe Scherblätter.  
 IOL Scissors, straight blades, angled  
 Grooves on the lower cutting blade guarantees no sliding effect while cutting the lens .  
 Secure cutting thanks to strong and sharp blades.  
 Tijera para IOL, hojas rectas, angulada  
 Las muescas en la hoja inferior evitan el efecto de resbalamiento mientras se corta la lente.  
 Corte seguro gracias a las hojas fuertes y agudas.  
 Ciseaux pour IOL, lames droites, coudé  
 Les dentelures sur la lame inférieure suppriment l'effet de glissement pendant la coupe de la lentille.  
 Coupe sécurisée grâce aux lames très coupantes.



1/1



H-4250

Mikro-Schere, 135° gebogen, sehr fein, 11 cm  
 Micro-Scissors, 135° curved, very delicate, 11 cm  
 Micro-tijera, 135° curva, fina, 11 cm  
 Micro-ciseaux, 135° courbes, fins, 11 cm



1/1

H-4251

Mikro-Schere, 120° gebogen, sehr fein, 11 cm  
 Micro-Scissors, 120° curved, very delicate, 11 cm  
 Micro-tijera, 120° curva, fina, 11 cm  
 Micro-ciseaux, 120° courbes, fins, 11 cm



1/1

H-4252

Mikro-Schere, 90° gebogen, sehr fein, 11 cm  
 Micro-Scissors, 90° curved, very delicate, 11 cm  
 Micro-tijera, 90° curva, fina, 11 cm  
 Micro-ciseaux, 90° courbes, fins, 11 cm



1/1

### Westcott

Sehnenschere,  
 Tenotomy scissors,  
 Pinza-tijera para tenotomia,  
 Pince-ciseaux à tendons,

H-4270

stumpf, 11 cm  
 blunt, 11 cm  
 roma, 11 cm  
 mousse, 11 cm



1/1

H-4270G

stumpf, 11 cm, mit Skalierung  
 blunt, 11 cm, graduated  
 roma, 11 cm, graduada  
 mousse, 11 cm, graduée



2/1

H-4270L Westcott

Sehnenschere, stumpf, links, 11 cm  
 Tenotomy scissors, blunt, left, 11 cm  
 Pinza-tijera para tenotomia, roma, izquierda, 11 cm  
 Pince-ciseaux à tendons, mousse, gauche, 11 cm



1/1

**H-4271 Westcott**  
 Sehnenschere, spitz, 11 cm  
 Tenotomy scissors, pointed, 11 cm  
 Pinza-tijera para tenotomia, aguda, 11 cm  
 Pince-ciseaux à tendons, pointus, 11 cm



1/1

**H-4306 McPherson-Westcott**  
 Sehnenschere, gebogen, stumpf, 10 cm  
 Tenotomy scissors, curved, blunt, 10 cm  
 Pinza-tijera para tenotomia, curva, roma, 10 cm  
 Pince-ciseaux à tendons, courbe, mousse, 10 cm



1/1

**H-4306A McPherson-Westcott**  
 Sehnenschere, gebogen, spitz, 10 cm  
 Tenotomy scissors, curved, pointed, 10 cm  
 Pinza-tijera para tenotomia, curva, aguda, 10 cm  
 Pince-ciseaux à tendons, courbe, pointus, 10 cm



1/1

**Westcott**  
 Sehnenschere,  
 Tenotomy scissors,  
 Pinza-tijera para tenotomia,  
 Pince-ciseaux à tendons,

**H-4272** stumpf, mittleres Blatt  
 blunt, medium blade  
 roma  
 mousse



1/1

**H-4272A** spitz, mittleres Blatt  
 pointed, medium blade  
 aguda  
 pointus

**H-4272G** stumpf, mittleres Blatt,  
 mit Skalierung  
 blunt, medium blade,  
 graduated  
 roma, graduada  
 mousse, graduée



2/1

**Westcott**

Sehnenscherere  
 Tenotomy scissors  
 Pinza-tijera para tenotomia  
 Pince-ciseaux à tendons



**H-4370**

stumpf, breiter Griff, 14 cm  
 blunt, wide handle, 14 cm  
 roma mango ancho, 14 cm  
 mousses, manche large, 14 cm



**H-4370G**

stumpf, breiter Griff, 14 cm, mit Skalierung  
 blunt, wide handle, 14 cm, graduated  
 roma mango ancho, 14 cm, graduada  
 mousses, manche large, 14 cm, graduée

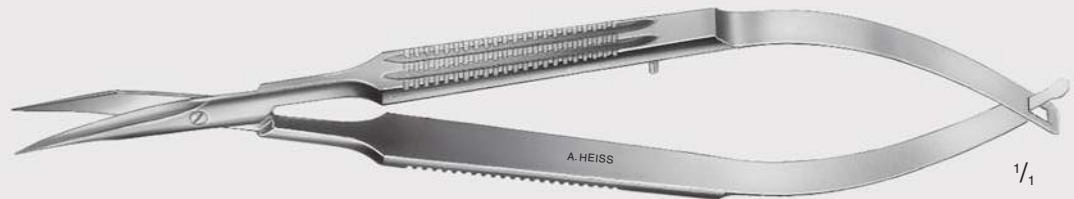

**H-4371**

**Westcott**

Sehnenscherere, spitz, breiter Griff, 14 cm  
 Tenotomy scissors, pointed, wide handle, 14 cm  
 Pinza-tijera para tenotomia, aguda mango ancho, 14 cm  
 Pince-ciseaux à tendons, pointus, manche large, 14 cm



**H-4290**

**Barraquer**

Hornhautschere, über die Fläche abgewinkelt, mit Stop und Sperre, 11 cm  
 Corneal scissors, angled to side, with stop and lock, 11 cm  
 Pinza-tijera para la córnea, angulosa, con tope y cierre, 11 cm  
 Pince-ciseaux cornéenne, anglés, avec arrête fermeture et verrou, 11 cm



**H-4300**

**Castroviejo**

Hornhautschere, kniegebogen, 10 cm  
 Corneal scissors, angled to side, 10 cm  
 Pinza-tijera para córnea, acodada, 10 cm  
 Pince-ciseaux cornéenne, coudée, 10 cm



**H-4302** Mikro-Schere, gerade, spitz, 10.5 cm  
Micro-Scissors, straight, pointed, 10.5 cm  
Micro-Pinza-tijera, recta, aguda, 10.5 cm  
Micro-Pince-ciseaux, droits, pointus, 10.5 cm



**H-4302A** Mikro-Schere, gerade, stumpf, 10.5 cm  
Micro-Scissors, straight, blunt, 10.5 cm  
Micro-Pinza-tijera, recta, roma, 10.5 cm  
Micro-Pince-ciseaux, droits, mouses, 10.5 cm



**H-4303** Mikro-Schere, gebogen, spitz, 10.5 cm  
Micro-Scissors, curved, pointed, 10.5 cm  
Micro-Pinza-tijera, curva, aguda, 10.5 cm  
Micro-Pince-ciseaux, courbes, pointus, 10.5 cm



**H-4303A** Mikro-Schere, gebogen, stumpf, 10.5 cm  
Micro-Scissors, curved, blunt, 10.5 cm  
Micro-Pinza-tijera, curva, roma, 10.5 cm  
Micro-Pince-ciseaux, courbes, mouses, 10.5 cm



**H-4304** Mikro-Keratome-Schere, gebogen, stumpf, 10.5 cm  
Micro-Corneal scissors, curved, blunt, 10.5 cm  
Micro-Pinza-tijera para la córnea, curva, roma, 10.5 cm  
Micro-Pince-ciseaux, courbes, mouses, 10.5 cm



**H-4305** Mikro-Hornhaut-Schere, kniegebogen, stumpf, 10.5 cm  
Micro-Corneal scissors, angled, blunt, 10.5 cm  
Micro-Pinza-tijera para la córnea, acodada, roma, 10.5 cm  
Micro-Pince-ciseaux, cornéenne, coudée, 10.5 cm



**H-4307** Mikro-Hornhaut-Schere, über Fläche abgewinkelt, stumpf, 10.5 cm  
Micro-Corneal scissors, angled, blunt, 10.5 cm  
Micro-Pinza-tijera para la córnea, acodada, roma, 10.5 cm  
Micro-Pince-ciseaux, cornéenne, coudée, mousse, 10.5 cm



H-4319

**Walker**

Hornhautschere, gerade  
Corneal scissors, straight  
Pinza-tijera para córnea, recta  
Pince-ciseaux cornéenne, droits



H-4310

**Castroviejo**

Hornhautschere, aufgebogen, 14 mm, stumpf, 10 cm  
Corneal scissors, curved, 14 mm, blunt, 10 cm  
Pinza-tijera para la córnea, curva, 14 mm, roma, 10 cm  
Pince-ciseaux cornéenne, courbes, mousses, 10 cm



H-4311

**Castroviejo**

Hornhautschere, schwach aufgebogen, 16 mm, stumpf, 10 cm  
Corneal scissors, slightly curved, 16 mm, blunt, 10 cm  
Pinza-tijera para la córnea, curvatura suave, 16 mm, roma, 10 cm  
Pince-ciseaux cornéenne, demi-courbes, 16 mm, mousses, 10 cm



H-4312

Hornhautschere, gebogen, 10 mm, spitz, 10.5 cm  
Corneal scissors, curved, 10 mm, pointed, 10.5 cm  
Pinza-tijera para la córnea, curva, 10 mm, aguda, 10.5 cm  
Pince-ciseaux cornéenne, courbes, 10 mm, pointus, 10.5 cm



H-4312A

Hornhautschere, gebogen, 10 mm, stumpf, 10.5 cm  
Corneal scissors, curved, 10 mm, blunt, 10.5 cm  
Pinza-tijera para córnea, curva, 10 mm, roma, 10.5 cm  
Pince-ciseaux cornéenne, courbes, 10 mm, mousses, 10.5 cm



### Katzin

Mikro-Hornhautschere, 10 cm  
Micro-Corneal transplant scissors, 10 cm  
Micro-Pinza-tijera para córnea, 10 cm  
Micro-Pince-ciseaux cornéenne, 10 cm

**H-4285** rechts ..... derecha  
right ..... à droite

**H-4286** links ..... izquierda  
left ..... à gauche



### Troutman

Mikro-Hornhautschere, 10 cm  
Micro-Corneal transplant scissors, 10 cm  
Micro-Pinza-tijera para la córnea, 10 cm  
Micro-Pince-ciseaux cornéenne, 10 cm

**H-4315** rechts ..... derecha  
right ..... à droite

**H-4316** links ..... izquierda  
left ..... à gauche



### Troutman-Barraquer

Mikro-Hornhautschere, mit Stop und Sperre, 10 cm  
Micro-Corneal transplant scissors, with stop and lock, 10 cm  
Micro-Pinza-tijera para la córnea, con tope y cierre, 10 cm  
Micro-Pince-ciseaux cornéenne, avec arrêt de fermeture et verrou, 10 cm

**H-4317** rechts ..... derecha  
right ..... à droite

**H-4318** links ..... izquierda  
left ..... à gauche





### Castroviejo

Hornhaut Schere, Blattlänge 11 mm, 10.5 cm

Corneal scissors, blade 11 mm, 10.5 cm

Pinza-tijera para la córnea, hojas 11 mm de largo, 10.5 cm

Pince-ciseaux cornéenne, lames 11 mm, 10.5 cm

**H-4325** rechts : derecha  
right : à droite

**H-4326** links : izquierda  
left : à gauche



### H-4330 Castroviejo

Schere für vordere Synechie, 10.5 cm

Anterior synechia scissors, 10.5 cm

Pinza-tijera sinequia anterior, 10.5 cm

Pince-ciseaux pour synéchie antérieure, 10.5 cm





**H-4360 Castroviejo**

Hornhaut Schere, aufgebogen, stumpf, breiter Griff, Blattlänge 14 mm, 13 cm

Corneal scissors, curved, blunt, wide handle, blade 14 mm, 13 cm

Pinza-tijera para la córnea, curva, roma, mango ancho, hojas 14 mm de largo, 13 cm

Pince-ciseaux cornéenne, courbes, mousse, manche large, lames 14 mm, 13 cm



**H-4375 Castroviejo**

Mikro-Schere für Keratoplastik, gebogen, spitz, breiter Griff, 13 cm

Micro-scissors, keratoplasty stitch, curved, pointed, wide handle, 13 cm

Micro-Pinza-tijera para queratoplastia, curva, aguda, mango ancho, 13 cm

Micro-Pince-ciseaux pour k eratoplastie, courbes, pointus, manche large, 13 cm



**H-6400** Vitrektomie Schere gerade, 20 ga  
Vitreotomy scissors, straight, 20 ga  
Tijera para vitrectomia, recta, 20 ga  
Ciseaux pour vitrectomie, droit, 20 ga



**H-6405** Vitrektomie Schere gewinkelt, 30°, 20 ga  
Vitreotomy scissors, angled 30°, 20 ga  
Tijera para vitrectomia, angulada 30°, 20 ga  
Ciseaux pour vitrectomie coudée, 30°, 20 ga



**H-6410** Vitrektomie Schere gewinkelt, 60°, 20 ga  
Vitreotomy scissors, angled 60°, 20 ga  
Tijera para vitrectomia, angulada 60°, 20 ga  
Ciseaux pour vitrectomie coudée, 60°, 20 ga



**H-6415** Vitrektomie Schere gewinkelt, 90°, 20 ga  
Vitreotomy scissors, angled 90°, 20 ga  
Tijera para vitrectomia, angulada 90°, 20 ga  
Ciseaux pour vitrectomie coudée, 90°, 20 ga



**H-2090** Druckplatte  
Pressure plate  
Placa de presión  
Plateau de pression



**H-3005** Kanülenpinzette  
Forceps for removal of cannulas  
Pinza para la extracción de cánulas  
Pince pour retrait de canules





1/1



Vitrektomie Schere, Titangriff  
Vitrectomy scissors, titanium handle  
Tijera para vitrectomia, mango titanio  
Ciseaux pour vitrectomie, manche titane

**H-6402**

20 ga, gerade  
20 ga, straight  
20 ga, recta  
20 ga, droit



**H-6403**

23 ga, gerade  
23 ga, straight  
23 ga, recta  
23 ga, droit



**H-6404**

23 ga, gerade, 2 mm  
23 ga, straight, 2 mm  
23 ga, recta, 2 mm  
23 ga, droit, 2 mm



**H-6407**

20 ga, 30° gewinkelt  
20 ga, angled 30°  
20 ga, angulada 30°  
20 ga, coudée, 30°



**H-6412**

20 ga, 60° gewinkelt  
20 ga, angled 60°  
20 ga, angulada 60°  
20 ga, coudée, 60°



**H-6417**

20 ga, 90° gewinkelt  
20 ga, angled 90°  
20 ga, angulada 90°  
20 ga, coudée, 90°



**H-4000** Irisschere, gerade, 9 cm  
 Iris scissors, straight, 9 cm  
 Tijera para iridectomia, recta, 9 cm  
 Ciseaux pour iridectomie, droits, 9 cm



**H-4000M** gerade, stumpf, 9 cm  
 Iris, straight, blunt, 9 cm  
 recta, roma, 9 cm,  
 droits, mousse, 9 cm

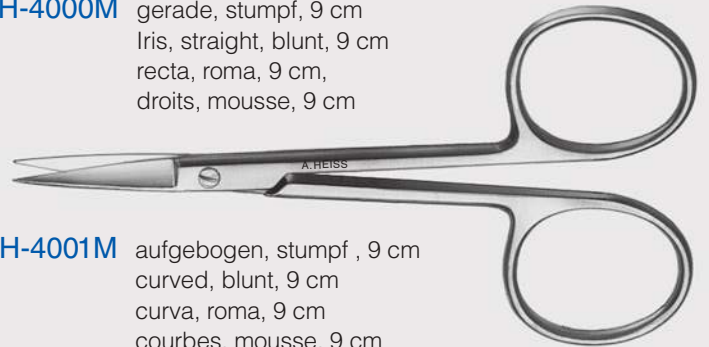

**H-4001** Irisschere, aufgebogen, 9 cm  
 Iris scissors, curved, 9 cm  
 Tijera para iridectomia, curva, 9 cm  
 Ciseaux pour iridectomie, courbes, 9 cm



**H-4001M** aufgebogen, stumpf, 9 cm  
 curved, blunt, 9 cm  
 curva, roma, 9 cm  
 courbes, mousse, 9 cm

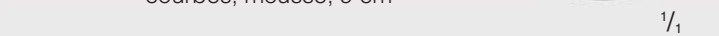

1/1

**H-4010** Irisschere, gerade, 10.5 cm  
 Iris scissors, straight, 10.5 cm  
 Tijera para iridectomia, recta, 10.5 cm  
 Ciseaux pour iridectomie, droits, 10.5 cm



**H-4010M** gerade, stumpf, 10.5 cm  
 straight, blunt, 10.5 cm  
 recta, roma, 10.5 cm  
 droits, mousses, 10.5 cm



**H-4011** Irisschere, aufgebogen, 10.5 cm  
 Iris scissors, curved, 10.5 cm  
 Tijera para iridectomia, curva, 10.5 cm  
 Ciseaux pour iridectomie, courbes, 10.5 cm



**H-4011M** aufgebogen, stumpf, 10.5 cm  
 curved, blunt, 10.5 cm  
 curva, roma, 10.5 cm  
 courbes, mousses, 10.5 cm



1/1

**H-4012** Irisschere, gerade, 11.5 cm  
 Iris scissors, straight, 11.5 cm  
 Tijera para iridectomia, recta, 11.5 cm  
 Ciseaux oculaires, droits 11.5 cm

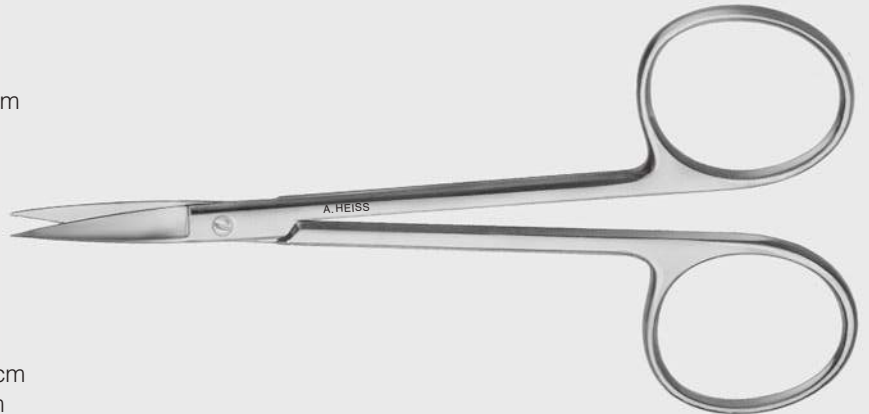

**H-4013** Irisschere, aufgebogen, 11.5 cm  
 Iris scissors, curved, 11.5 cm  
 Tijera para iridectomia, curva, 11.5 cm  
 Ciseaux oculaires, courbes, 11.5 cm

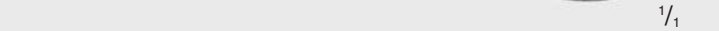

1/1

**H-4160** Irisschere, gebogen, fein, Modell Bonn, 9 cm  
 Iris scissors, curved, delicate, Bonn model, 9 cm  
 Tijera para iridectomia, curva, fina, modelo Bonn, 9 cm  
 Ciseaux pour iridectomie, courbes, fine, modèle Bonn, 9 cm



**H-4161** Irisschere, gerade, fein, Modell Bonn, 9 cm  
 Iris scissors, straight, delicate, Bonn model, 9 cm  
 Tijera para iridectomia, recta, fina, modelo Bonn, 9 cm  
 Ciseaux pour iridectomie, droits, fine, modèle Bonn, 9 cm

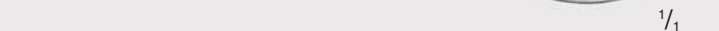

1/1

**H-4015A** Augenschere, gerade, spitz-spitz, 11.5 cm  
 Eye scissors, straight, pointed-pointed, 11.5 cm  
 Tijera ocular, recta, aguda-aguda, 11.5 cm  
 Ciseaux oculaires, droits, pointus-pointus, 11.5 cm



**H-4015B** Augenschere, gerade, spitz-stumpf, 11.5 cm  
 Eye scissors, straight, pointed-blunt, 11.5 cm  
 Tijera ocular, recta, aguda-roma, 11.5 cm  
 Ciseaux oculaires, droits, pointus-mousses, 11.5 cm



**H-4015C** Augenschere, gerade, stumpf-stumpf, 11.5 cm  
 Eye scissors, straight, blunt-blunt, 11.5 cm  
 Tijera ocular, recta, roma-roma, 11.5 cm  
 Ciseaux oculaires, droits, mousses-mousses, 11.5 cm



**H-4016A** Augenschere, gebogen, spitz-spitz, 11.5 cm  
 Eye scissors, curved, pointed-pointed, 11.5 cm  
 Tijera ocular, curva, aguda-aguda, 11.5 cm  
 Ciseaux oculaires, courbes, pointus-pointus, 11.5 cm



**H-4016B** Augenschere, gebogen, spitz-stumpf, 11.5 cm  
 Eye scissors, curved, pointed-blunt, 11.5 cm  
 Tijera ocular, curva, aguda-roma, 11.5 cm  
 Ciseaux oculaires, courbes, pointus-mousses, 11.5 cm



**H-4016C** Augenschere, gebogen, stumpf-stumpf, 11.5 cm  
 Eye scissors, curved, blunt-blunt, 11.5 cm  
 Tijera ocular, curva roma-roma, 11,5 cm  
 Ciseaux oculaires, courbes, mousses-mousses, 11.5 cm



**H-4020** Augenschere, gerade, spitz, 12.5 cm  
 Eye scissors, straight, pointed, 12.5 cm  
 Tijera ocular, recta, aguda, 12.5 cm  
 Ciseaux oculaires, droits, pointus, 12.5 cm



**H-4021** Augenschere, gebogen, spitz, 12.5 cm  
 Eye scissors, curved, pointed, 12.5 cm  
 Tijera ocular, curva, aguda, 12.5 cm  
 Ciseaux oculaires, courbes, pointus, 12.5 cm



**H-4030** Augenschere, gerade, stumpf, 12.5 cm  
 Eye scissors, straight, blunt, 12.5 cm  
 Tijera ocular, recta, roma, 12.5 cm  
 Ciseaux oculaires, droits, mousses, 12.5 cm

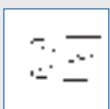

**H-4031** Augenschere, gebogen, stumpf, 12.5 cm  
 Eye scissors, curved, blunt, 12.5 cm  
 Tijera ocular, curva, roma, 12.5 cm  
 Ciseaux oculaires, courbes, mousses, 12.5 cm

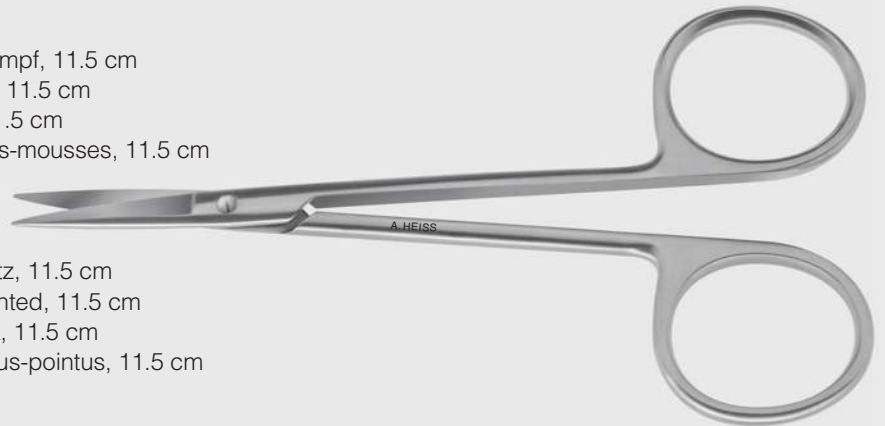
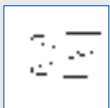

1/1



1/1

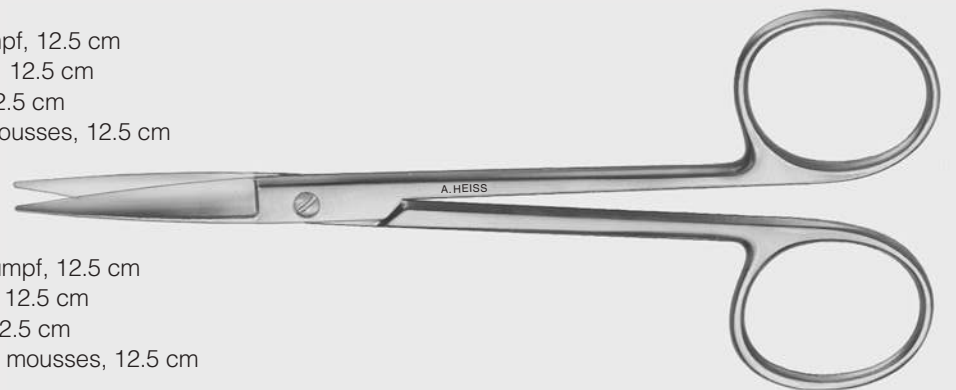

1/1

**H-4050** Strabismusschere, gerade, 12 cm  
 Strabismus scissors, straight, 12 cm  
 Tijera para estrabismo, recta, 12 cm  
 Ciseaux à strabisme, droits, 12 cm



**H-4051** Strabismusschere, gebogen, 12 cm  
 Strabismus scissors, curved, 12 cm  
 Tijera para estrabismo, curva, 12 cm  
 Ciseaux à strabisme, courbes, 12 cm



1/1

**H-4055** Strabismusschere, gerade, 10 cm  
 Strabismus scissors, straight, 10 cm  
 Tijera para estrabismo, recta, 10 cm  
 Ciseaux à strabisme, droits, 10 cm



**H-4056** Strabismusschere, gebogen, 10 cm  
 Strabismus scissors, curved, 10 cm  
 Tijera para estrabismo, curva, 10 cm  
 Ciseaux à strabisme, courbes, 10 cm



1/1

**H-4060** Strabismusschere, gerade, mit zwei Knöpfchen 11.5 cm  
 Strabismus scissors, straight, probe points, 11.5 cm  
 Tijera para estrabismo, recta, abotonada, 11.5 cm  
 Ciseaux à strabisme, droits, boutonnés, 11.5 cm

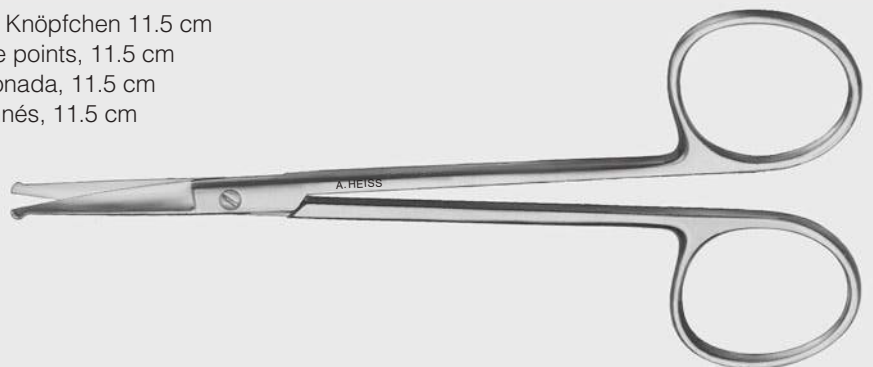

1/1

**H-4100    Stevens**

Sehnenschere, gerade, kurzes Modell, stumpf, 10.5 cm  
Tenotomy scissors, straight, short model, blunt, 10.5 cm  
Tijera-tenótomo, recta, modelo corta, roma, 10.5 cm  
Ciseaux à tendons, modèle court, droits, mousses, 10.5 cm

**H-4101    Stevens**

Sehnenschere, gerade, kurzes Modell, spitz, 10.5 cm  
Tenotomy scissors, straight, short model, pointed, 10.5 cm  
Tijera-tenótomo, recta, modelo corto, aguda, 10.5 cm  
Ciseaux à tendons, modèle court, droits, pointus, 10.5 cm



**H-4110    Stevens**

Sehnenschere, gebogen, kurzes Modell, stumpf, 10.5 cm  
Tenotomy scissors, curved, short model, blunt, 10.5 cm  
Tijera-tenótomo, curva, modelo corto, roma, 10.5 cm  
Ciseaux à tendons, modèle court, courbes, mousses, 10.5 cm

**H-4111    Stevens**

Sehnenschere, gebogen, kurzes Modell, spitz, 10.5 cm  
Tenotomy scissors, curved, short model, pointed, 10.5 cm  
Tijera-tenótomo, curva, modelo corto, aguda, 10.5 cm  
Ciseaux à tendons, modèle court, courbes, pointus, 10.5 cm

**H-4120    Stevens**

Sehnenschere, gerade, langes Modell, stumpf, 11 cm  
Tenotomy scissors, straight, long model, blunt, 11 cm  
Tijera-tenótomo, recta, modelo largo, roma, 11 cm  
Ciseaux à tendons, modèle long, droit, mousses, 11 cm

**H-4121    Stevens**

Sehnenschere, gerade, langes Modell, spitz, 11 cm  
Tenotomy scissors, straight, long model, pointed, 11 cm  
Tijera-tenótomo, recta, modelo largo, aguda, 11 cm  
Ciseaux à tendons, modèle longue, droit, pointus, 11 cm



**H-4130    Stevens**

Sehnenschere, gebogen, langes Modell, stumpf, 11 cm  
Tenotomy scissors, curved, long model, blunt, 11 cm  
Tijera-tenótomo, curva, modelo largo, roma, 11 cm  
Ciseaux à tendons, modèle longue, courbes, mousses, 11 cm

**H-4131    Stevens**

Sehnenschere, gebogen, langes Modell, spitz, 11 cm  
Tenotomy scissors, curved, long model, pointed, 11 cm  
Tijera-tenótomo, curva, modelo largo, aguda, 11 cm  
Ciseaux à tendons, modèle longue, courbes, pointus, 11 cm



**H-4140** **Spencer**  
Ligaturschere, 9 cm  
Stitch scissors, 9 cm  
Tijera para incisión, 9 cm  
Ciseaux pour incision, 9 cm



**H-4150** Enukleationsschere, leicht gebogen, 13.5 cm  
Enucleation scissors, half-curved, 13.5 cm  
Tijera para enucleación, curvadura suave, 13.5 cm  
Ciseaux à enucléer, demi-courbes, 13.5 cm



**H-4155** Enukleationsschere, stark gebogen, 13.5 cm  
Enucleation scissors, full-curved, 13.5 cm  
Tijera para enucleación, curvadura fuerte, 13.5 cm  
Ciseaux à enucléer, très courbes, 13.5 cm



**H-4180** **Lagrange**  
Sklerektomieschere, 12 cm  
Sclerectomy scissors, 12 cm  
Tijera para esclerectomia, 12 cm  
Ciseaux à sclérectomie, 12 cm



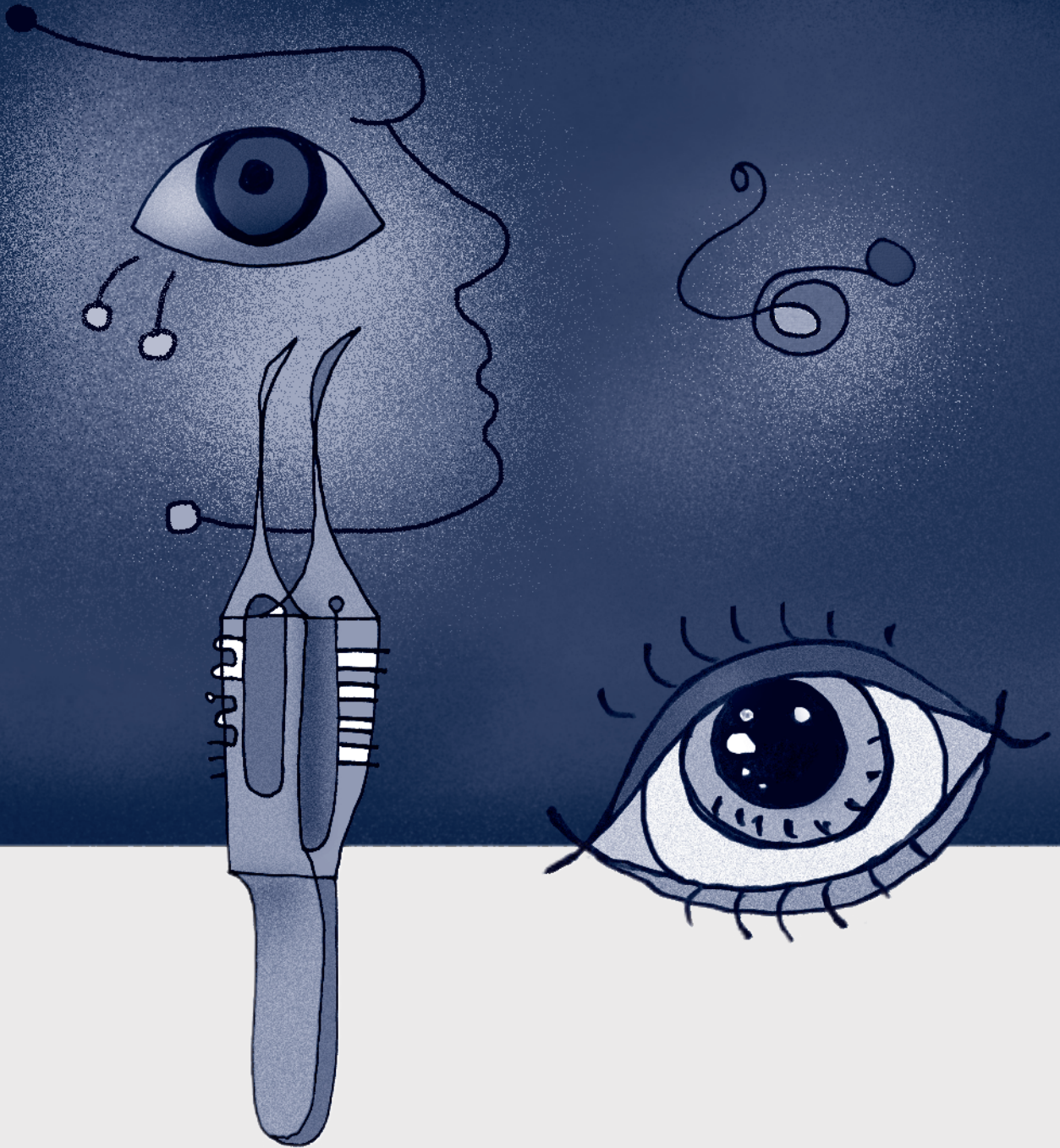

# 6

- Titaninstrumente
- Titanium Instruments
- Instrumentos Titanio
- Instruments Titane

**HT-1900**

**Sinskey**



Linsenhäkchen, 0.2 mm, abgewinkelt  
 Lens hook, 0.2 mm, angled  
 Gancho para manipulación de lente, 0.2 mm, angulado  
 Crochet à manipulateur à implant, 0.2 mm, coudé

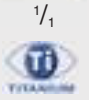

**HT-1910**

Linsenspatel, 0.5 mm, abgewinkelt  
 Lens spatula, 0.5 mm, angled, blunt  
 Espátula para el cristalino, 0.5 mm, angulada, roma  
 Spatule pour la cristalline, 0.5 mm, coudé



**Lester**

IOL Manipulator  
 IOL manipulator  
 Gancho para manipulación de IOL  
 IOL manipulateur

**HT-1925**

0.25 mm, gerade  
 0.25 mm, straight  
 0.25 mm, recto  
 0.25 mm, droit



**HT-1930**

0.25 mm, abgewinkelt  
 0.25 mm, angled  
 0.25 mm, angulado  
 0.25 mm, coudé



**HT-1950**

**Drysdale**



Linsenkernmanipulator  
 Nucleus manipulator  
 Manipulator para núcleo de lente  
 Crochet manipulateur, droit







**HT-1935** Linsenkernrotator, Y-Spitze, abgewinkelt  
Nucleus rotator, Y-tip, angled  
Rotator para núcleo, forma Y, angulado  
Crochet manipulateur de noyau, coudé, extrémité en Y



**HT-1940** Irishäkchen, abgewinkelt  
Iris hook, angled  
Ganco para Iris, angulado  
Crochet pour l'iris, coudé



**HT-1945** Kernspalter, 90°, abgewinkelt  
Phaco chopper, 90°, angled  
Gancho par separación de núcleo, 90°, angulado  
Phaco cliveur, 90°, coudé



**HT-1945-1** Kernspalter, 90°, 1.4 mm, abgewinkelt  
Phaco chopper, 90°, 1.4 mm, angled  
Gancho par separación de núcleo, 1.4 mm, 90°, angulado  
Phaco cliveur, 90°, 1.4 mm, coudé



**HT-1946** Kernspalter, 60°, abgewinkelt  
Phaco chopper, 60°, angled  
Gancho par separación de núcleo, 60°, angulado  
Phaco cliveur, 60°, coudé



**HT-1920** Kernspalter, abgewinkelt  
Nucleus divider, angled  
Gancho par separación de núcleo, angulado  
Crochet à téntomie Stevens, coudé



**HT-3000**



Fadenpinzette, gerade, 0.3 mm, ohne Fadenplatte  
Tying forceps, straight, 0.3 mm, without tying platform  
Pinza para anudar, recta, 0.3 mm, sin plataforma  
Pince à fils, droite, 0.3 mm, sans plateforme



1/1



**HT-3010**



Fadenlöspinzette, Colibri  
Suture removal forceps, Colibri type  
Pinza para soltar los puntos de sutura, tipo Colibri  
Pince enlever points de suture, Colibri



1/1



**HT-3025A**



Fadenpinzette, gerade, 0.3 mm, mit 6 mm Fadenplatte  
Tying forceps, straight, 0.3 mm, with 6 mm tying platform  
Pinza para anudar, recta, 0.3 mm, con plataforma de 6 mm  
Pince à fils, droite, 0.3 mm, avec plateforme de 6 mm



1/1



**HT-3025B**



Fadenpinzette, gebogen, 0.3 mm, mit 6 mm Fadenplatte  
Tying forceps, curved, 0.3 mm, with 6 mm tying platform  
Pinza para anudar, curva, 0.3 mm, con plataforma de 6 mm  
Pince à fils, courbe, 0.3 mm, avec plateforme de 6 mm



1/1



**HT-3030**



**Kelman-McPherson**  
Fadenpinzette, abgewinkelt, mit 7 mm Fadenplatte  
Tying forceps, angled, 7 mm tying platform  
Pinza para anudar, angulada, con plataforma de 7 mm  
Pince à fils, coudée, avec plateforme de 7 mm



1/1



**HT-3031**



**Kelman-McPherson**  
Fadenpinzette, gerade, mit 7 mm Fadenplatte  
Tying forceps, straight, 7 mm tying platform  
Pinza para anudar, recta, con plataforma de 7 mm  
Pince à fils, droite, avec plateforme de 7 mm



1/1



HT-3035

**Kelman-McPherson**



Fadenpinzette, abgewinkelt, mit 11 mm Fadenplatte  
Tying forceps, angled, 11 mm tying platform  
Pinza para anudar, angulada, con plataforma de 11 mm  
Pince à fils, coudée, avec plateforme de 11 mm



1/1



HT-3036

**Kelman-McPherson**



Fadenpinzette, gerade, mit 11 mm Fadenplatte  
Tying forceps, straight, 11 mm tying platform  
Pinza para anudar, recta, con plataforma de 11 mm  
Pince à fils, droite, avec plateforme de 11 mm



1/1



HT-3420

**Troutman**



Mikro-Fadenpinzette, gerade, sehr fein, mit 5 mm Fadenplatte, 11.5 cm  
Micro-Tying forceps, straight, very delicate, 5 mm tying platform, 11.5 cm  
Micro-Pinza para anudar, recta, mui fina, con plataforma de 5 mm, 11.5 cm  
Micro-Pince à fils, droit, très fine, avec plateforme de 5 mm, 11.5 cm



1/1



H-3420A

**Troutman**



Mikro-Fadenpinzette, gebogen, sehr fein, mit 5 mm Fadenplatte, 11.5 cm  
Micro-Tying forceps, curved, very delicate, 5 mm tying platform, 11.5 cm  
Micro-Pinza para anudar, curva, mui fina, con plataforma de 5 mm, 11.5 cm  
Micro-Pince à fils, courbe, très fine, avec plateforme de 5 mm, 11.5 cm



1/1



HT-3525A

**McPherson**



Mikro-Fadenpinzette, gerade, mit 5 mm Fadenplatte, 10.5 cm  
Micro-Tying forceps, straight, 5 mm tying platform, 10.5 cm  
Micro-Pinza para anudar, recta, con plataforma de 5 mm, 10.5 cm  
Micro-Pince à fils, droite, avec plateforme de 5 mm, 10.5 cm



1/1



HT-3525B

**McPherson**



Mikro-Fadenpinzette, abgewinkelt, mit 5 mm Fadenplatte, 10.5 cm  
Micro-Tying forceps, angled, 5 mm tying platform, 10.5 cm  
Micro-Pinza para anudar, angulada, con plataforma de 5 mm, 10.5 cm  
Micro-Pince à fils, coudée, avec plateforme de 5 mm, 10.5 cm



1/1





HT-3545

**Gaskin**

Fragmentpinzette, abgewinkelt, sehr feine, 11 mm lange Spitzen, 8 mm Griff, 10,5 cm  
Fragment forceps, angled, very delicate 11 mm long smooth jaws, 8 mm handle, 10.5 cm  
Pinza de fragmento, angulada, puntas delicadísimas con una plataforma de 11 mm, mango 8 mm, 10,5 cm  
Pince à fragments, coudée, pointes délicates, 11 mm, manche 8 mm, 10,5 cm



1/1



HT-3020

Nahtpinzette, Colibri, 1 x 2 Zähne, 0.12 mm, 90° Zähne, mit Fadenplatte  
Suture forceps, Colibri type, 1 x 2 teeth, 0.12 mm, 90° teeth, with tying platform  
Pinza para sutura, tipo Colibri, 1 x 2 dientes, 0.12 mm, 90° dientes, con plataforma  
Pince à suture, type Colibri, 1 x 2 griffes, 0.12 mm, griffes 90°, avec plateforme



1/1



HT-3021

Nahtpinzette, Colibri, 1 x 2 Zähne, 0.12 mm, 90° Zähne, ohne Fadenplatte  
Suture forceps, Colibri type, 1 x 2 teeth, 0.12 mm, 90° teeth, without tying platform  
Pinza para sutura, tipo Colibri, 1 x 2 dientes, 0.12 mm, 90° dientes, sin plataforma  
Pince à suture, type Colibri, 1 x 2 griffes, 0.12 mm, griffes 90°, sans plateforme



1/1



HT-3022

Nahtpinzette, Colibri, 1 x 2 Zähne, 0.12 mm, 45° Zähne, mit Fadenplatte  
Suture forceps, Colibri Type, 1 x 2 teeth, 0.12 mm, 45° teeth, with tying platform  
Pinza para sutura, tipo Colibri, 1 x 2 dientes, 0.12 mm, 45° dientes, con plataforma  
Pince à suture, type Colibri, 1 x 2 griffes, 0.12 mm, griffes 45°, avec plateforme



1/1



HT-3530A    **McPherson**

Hornhautpinzette, gerade, 1 x 2 Zähne, 0.4 mm, Fadenplatte, 10,5 cm  
Corneal forceps, straight, 1 x 2 teeth, 0.4 mm, tying platform, 10.5 cm  
Pinza para cornéa, recta, 1 x 2 dientes, 0.4 mm, con plataforma, 10,5 cm  
Pince pour la cornée, droite, à 1 x 2 griffes, 0.4 mm, avec plateforme, 10,5 cm



1/1



HT-3530B    **McPherson**

Hornhautpinzette, abgewinkelt, 1 x 2 Zähne, 0.4 mm, Fadenplatte, 10,5 cm  
Corneal forceps, angled, 1 x 2 teeth, 0.4 mm, tying platform, 10.5 cm  
Pinza para cornéa, angulada, 1 x 2 dientes, 0.4 mm, con plataforma, 10,5 cm  
Pince pour la cornée, coudée, à 1 x 2 griffes, 0.4 mm, avec plateforme, 10,5 cm



1/1





HT-3110



**Kelman-McPherson**

Nahtpinzette, abgewinkelt, 1 × 2 Zähne, 0.12 mm, mit 7 mm Fadenplatte  
Suture forceps, 1 × 2 teeth, 0.12 mm, with 7 mm tying platform, angled  
Pinza para sutura, 1 × 2 dientes, 0.12 mm, con plataforma de 7 mm, angulada  
Pince à suture, coudé, 1 × 2 griffes, 0.12 mm, avec plateforme de 7 mm



1/1



HT-3111



**Kelman-McPherson**

Nahtpinzette, gerade, 1 × 2 Zähne, 0.12 mm, mit 7 mm Fadenplatte  
Suture forceps, 1 × 2 teeth, 0.12 mm, with 7 mm tying platform, straight  
Pinza para sutura, 1 × 2 dientes, 0.12 mm, con plataforma de 7 mm, recta  
Pince à suture, droit, 1 × 2 griffes, 0.12 mm, avec plateforme de 7 mm



1/1



HT-3120



**Kelman-McPherson**

Nahtpinzette, abgewinkelt, 1 × 2 Zähne, 0.12 mm, mit 11 mm Fadenplatte  
Suture forceps, 1 × 2 teeth, 0.12 mm, with 11 mm tying platform, angled  
Pinza para sutura, 1 × 2 dientes, 0.12 mm, con plataforma de 11 mm, angulada  
Pince à suture, abgewinkelt, 1 × 2 griffes, 0.12 mm, avec plateforme de 11 mm



1/1



HT-3121



**Kelman-McPherson**

Nahtpinzette, 1 × 2 Zähne, 0.12 mm, gerade, mit 11 mm Fadenplatte  
Suture forceps, 1 × 2 teeth, 0.12 mm, with 11 mm tying platform, straight  
Pinza para sutura, 1 × 2 dientes, 0.12 mm, con plataforma de 11 mm, recta  
Pince à suture, 1 × 2 griffes, 0.12 mm, droit, avec plateforme de 7 mm



1/1



HT-3130



Nahtpinzette, 1 × 2 Zähne, 0.12 mm, 45° Zähne, mit 7 mm Fadenplatte  
Suture forceps, 1 × 2 Teeth, 0.12 mm, 45° teeth, with 7 mm tying platform  
Pinza para sutura, 1 × 2 dientes, 0.12 mm, 45° dientes, con plataforma de 7 mm  
Pince à suture, 1 × 2 griffes, 0.12 mm, griffes 45°, avec plateforme de 7 mm



1/1





A. HEISS

1/1

**HT-3415**

Mikro-Irispinzette, Modell Bonn, 1 × 2 Zähne, 0.12 mm, mit Fadenplatte, runder Griff, 11.5 cm  
Micro-Iris forceps, Bonn model, 1 × 2 teeth, 0.12 mm, with tying platform, round handle, 11.5 cm  
Micro-Pinza para iris, modelo Bonn, 1 × 2 dientes, 0.12 mm, con plataforma, mango redondo, 11.5 cm  
Micro-Pince à iris, modèle Bonn, à 1 × 2 griffes, 0.12 mm, avec plateforme, manche rond, 11.5 cm



A. HEISS

1/1

**HT-3510**

Mikro-Irispinzette, Modell Bonn, langes Modell mit Fadenplatte, 1 × 2 Zähne, 0.12 mm  
Micro-Iris forceps, Bonn model, with tying platform, 1 × 2 teeth, 0.12 mm  
Micro-pinza para iris, modelo Bonn, largo, con plataforma, 1 × 2 dientes, 0.12 mm  
Micro-Pince à iris, modèle Bonn, avec plateforme, à 1 × 2 griffes, 0.12 mm



A. HEISS

1/1

**HT-3520A**

**Castroviejo**

Nahtpinzette 1 × 2 Zähne, 0.9 mm, breiter Griff, 10.5 cm  
Suture forceps, 1 × 2 teeth, 0.9 mm, wide handle, 10.5 cm  
Pinza para sutura, 1 × 2 dientes, 0.9 mm, con mango ancho, 10.5 cm  
Pince à suture, à 1 × 2 griffes, 0.9 mm, avec manche nouvelle, manche large, 10.5 cm



**HT-3520B**

**Castroviejo**

Nahtpinzette, 1 × 2 Zähne, 0.5 mm, breiter Griff, 10.5 cm  
Suture forceps, 1 × 2 teeth, 0.5 mm, wide handle, 10.5 cm  
Pinza para sutura, 1 × 2 dientes, 0.5 mm, con mango ancho, 10.5 cm  
Pince à suture, à 1 × 2 griffes, 0.5 mm, avec manche nouvelle, manche large, 10.5 cm

**HT-3520C**

**Castroviejo**

Nahtpinzette, 1 × 2 Zähne, 0.3 mm, breiter Griff, 10.5 cm  
Suture forceps, 1 × 2 teeth, 0.3 mm, wide handle, 10.5 cm  
Pinza para suturav, 1 × 2 dientes, 0.3 mm, con mango ancho, 10.5 cm  
Pince à suture, à 1 × 2 griffes, 0.3 mm, avec manche nouvelle, manche large, 10.5 cm

**HT-3520D**

**Castroviejo**

Nahtpinzette, 1 × 2 Zähne, 0.12 mm, breiter Griff, 10.5 cm  
Suture forceps, 1 × 2 teeth, 0.12 mm, wide handle, 10.5 cm  
Pinza para sutura, 1 × 2 dientes, 0.12 mm, con mango ancho, 10.5 cm  
Pince à suture, à 1 × 2 griffes, 0.12 mm, avec manche nouvelle, manche large, 10.5 cm

**HT-3376** Pierse



Mikro-Fixierpinzette, 1 × 1 Zähne, 0.3 mm, 8 cm  
Micro-Fixation forceps, 1 × 1 teeth, 0.3 mm, 8 cm  
Micro-Pinza para fijación, 1 × 1 dientes, 0.3 mm, 8 cm  
Micro-Pince à fixer, à 1 × 1 griffes, 0.3 mm, 8 cm



1/1



**HT-3378** Pierse



Mikro-Fixierpinzette, Colibri, 1 × 1 Zähne, 0.3 mm, 8 cm  
Micro-Fixation forceps, Colibri, 1 × 1 teeth, 0.3 mm, 8 cm  
Micro-Pinza para fijación, Colibri, 1 × 1 dientes, 0.3 mm, 8 cm  
Micro-Pince à fixer, Colibri, à 1 × 1 griffes, 0.3 mm, 8 cm



1/1



**HT-6080** Utrata



Kapsulorhexis Pinzette, abgewinkelt, gerade  
Capsulorhexis forceps, angled, straight  
Pinza para Capsulorhexis, angulada, recta  
Pince pour Capsulorhexis, coudée, droit



1/1



**HT-6090** Utrata



Kapsulorhexis Pinzette, abgewinkelt, gebogen  
Capsulorhexis forceps, angled curved  
Pinza para capsulorhexis, angulada curva  
Pince pour capsulorhexis, coudée, courbe



1/1



**HT-6081** Utrata



Kapsulorhexis Pinzette, abgewinkelt, gebogen, runder Griff  
Capsulorhexis forceps, angled curved, round handle  
Pinza para capsulorhexis, angulada curva, mango redondo  
Pince pour capsulorhexis, coudée, courbe, manche ronde



1/1



**HT-6091** Utrata



Kapsulorhexis Pinzette, abgewinkelt, gerade, runder Griff  
Capsulorhexis forceps, angled, straight, round handle  
Pinza para capsulorhexis, angulada, recta, mango redondo  
Pince pour capsulorhexis, coudée, droit, manche ronde



1/1





**HT-3430 Utrata**



Kapsulorhexis Pinzette, 11 mm lange Schenkel, Griff Ø 8 mm, 10.5 cm  
Capsulorhexis forceps, 11 mm shanks, handle Ø 8 mm, 10.5 cm  
Pinza para capsulorhexis, lados de un largo de 11 mm, mango Ø 8 mm, 10.5 cm  
Pince pour capsulorhexis, branches 11 mm, manche Ø 8 mm, 10.5 cm

1/1



**HT-3431 Utrata**



Kapsulorhexis Pinzette, runde Spitzen, Griff Ø 8 mm, 10.5 cm  
Capsulorhexis forceps, round tips, handle Ø 8 mm, 10.5 cm  
Pinza para capsulorhexis, puntas redondas, mango Ø 8 mm, 10.5 cm  
Pince pour capsulorhexis, mors ronds, manche Ø 8 mm, 10.5 cm

1/1



**HT-3432 Masket**



Kapsulorhexis Pinzette, 11 mm lange Schenkel, gebogen, Griff Ø 8 mm, 10.5 cm  
Capsulorhexis forceps, 11 mm vaulted shanks, handle Ø 8 mm, 10.5 cm  
Pinza para capsulorhexis, lados de un largo de 11 mm, mango Ø 8 mm, 10.5 cm  
Pince pour capsulorhexis, branches 11 mm, courbe, manche Ø 8 mm, 10.5 cm

1/1



**HT-3540 Utrata**



Kapsulorhexis Pinzette, sehr fein, 10.5 cm  
Capsulorhexis forceps, very delicate grasping tips, 10.5 cm  
Pinza para capsulorhexis, extra delicada, 10.5 cm  
Pince pour capsulorhexis, très fine, 10.5 cm

1/1



**HT-3541 Jaffe**



Kapsulorhexis Pinzette, runde Spitzen, 10.5 cm  
Capsulorhexis forceps, round tips, 10.5 cm  
Pinza para capsulorhexis, puntas redondas, 10.5 cm  
Pince pour capsulorhexis, extrémité mousse, 10.5 cm

1/1





**HT-3542** Lehner



Kapsulorhexis Pinzette, sehr fein, 10.5 cm  
Capsulorhexis forceps, very delicate grasping tips, 10.5 cm  
Pinza para capsulorhexis, extra delicada, 10.5 cm  
Pince pour capsulorhexis, très fine, 10.5 cm



**HT-4578A** Mikro Nadelhalter, gerade mit Schloss  
Micro-Needle holder, straight with lock  
Micro-Porta-Aguja, recta con cierre  
Micro-Porte-aiguille, droit, avec ressort



**HT-4578B** Mikro Nadelhalter, gerade ohne Schloss  
Micro-Needle holder, straight without lock  
Micro-Porta-Aguja, recta sin cierre  
Micro-Porte-aiguille, droit, sans ressort



**HT-4579A** Mikro Nadelhalter, gebogen, mit Schloss  
Micro-Needle holder, curved, with lock  
Micro-Porta-Aguja, curva, con cierre  
Micro-Porte-aiguille, courbe, avec ressort



**HT-4579B** Mikro Nadelhalter, gebogen ohne Schloss  
Micro-Needle holder, curved, without lock  
Micro-Porta-Aguja, curva, sin cierre  
Micro-Porte-aiguille, courbe, sans ressort







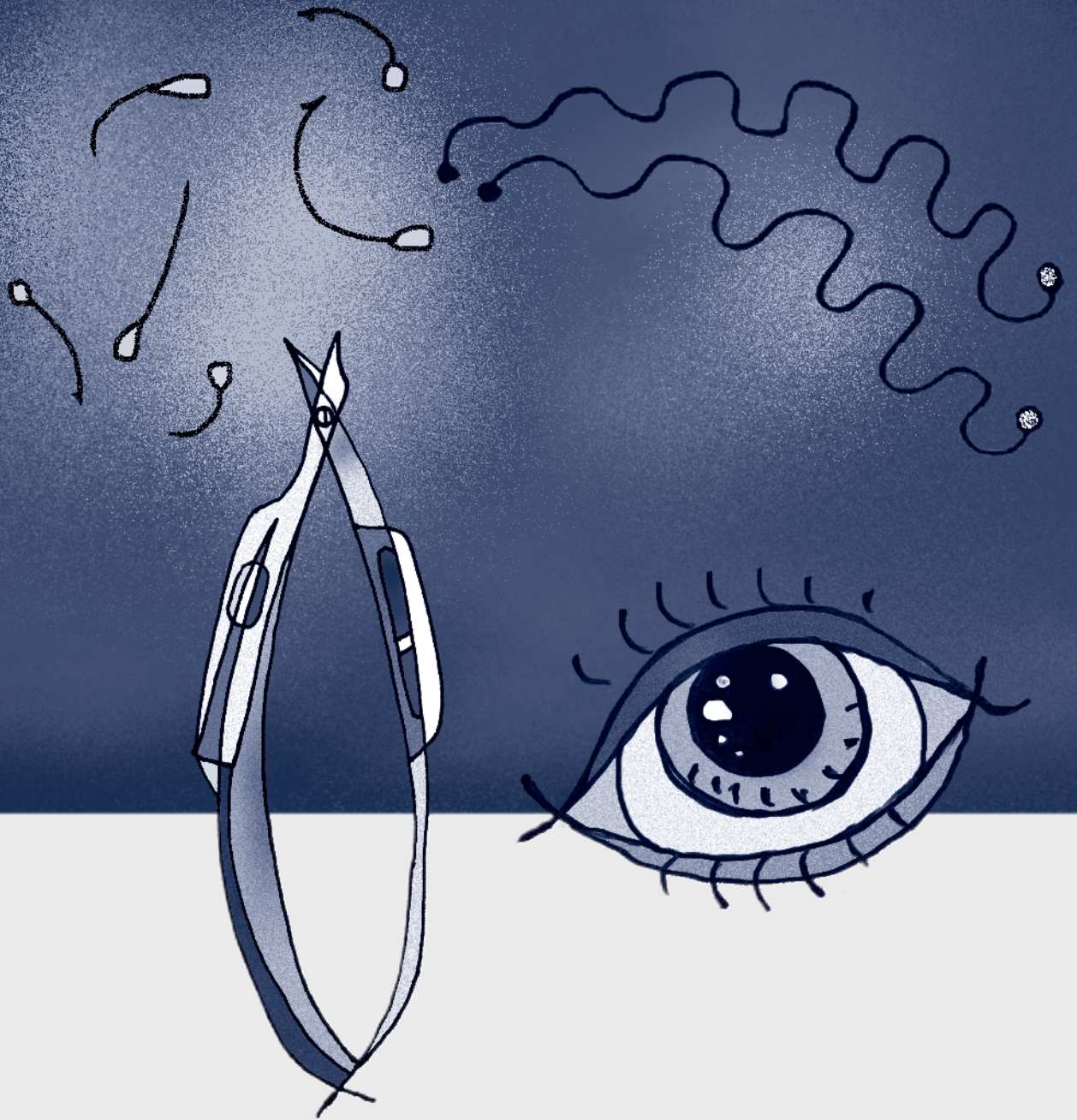

# 7

- Nadelhalter
- Needle Holders
- Porta-Agujas
- Porte-Aiguilles
-



H-4596

**Troutman**

Mikro-Klingenthalter, 9 cm  
 Micro-Blade holder, 9 cm  
 Micro-Porta-hoja de afeitar, 9 cm  
 Micro-Porte-lame de rasoir, 9 cm



1/1

H-4591

Klingenthalter, Schweizer Modell, 9 cm  
 Blade holder, Swiss model, 9 cm  
 Porta hoja, modelo Suizo, 9 cm  
 Porte-lame de rasoir, modèle suisse, 9 cm

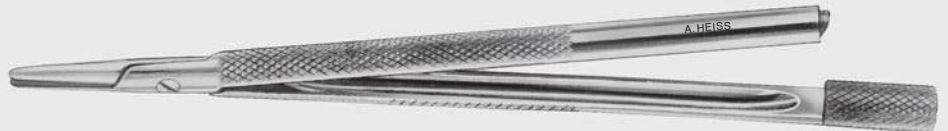

H-4592

Klingenthalter, Schweizer Modell, 12 cm  
 Blade holder, Swiss model, 12 cm  
 Porta hoja, modelo Suizo, 12 cm  
 Porte-lame de rasoir, modèle suisse, 12 cm

1/1

H-4594

**Barraquer**

Klingenthalter, 11 cm  
 Blade holder, 11 cm  
 Porta hoja de afeitar, 11 cm  
 Porte-lame de rasoir, 11 cm



1/1

H-4600

Rasierklingen, 10 Stück  
 Razor blades, 10 pieces  
 Hoja de afeitar, 10 piezas  
 Porte-lames, 10 pièces



1/1

H-4400

**Barraquer-Troutman**



Mikro-Nadelhalter, gerade, ohne Sperre, 0.6 × 9 mm, runder Griff, 9 cm  
 Micro Needle holder, straight, without lock, 0.6 × 9 mm, round handle, 9 cm  
 Micro-Porta-aquija, recta, sin cierre, 0.6 × 9 mm, con mango redondo, 9 cm  
 Micro-Porte-aiguille, droits, sans ressort, 0.6 × 9 mm, manche rond, 9 cm



H-4405

**Barraquer-Troutman**



Mikro-Nadelhalter, gebogen, ohne Sperre, 0.6 × 9 mm, runder Griff, 9 cm  
 Micro Needle holder, curved, without lock, 0.6 × 9 mm, round handle, 9 cm  
 Micro-Porta-aquija, curva, sin cierre, 0.6 × 9 mm, con mango redondo, 9 cm  
 Micro-Porte-aiguille, courbes, sans ressort, 0.6 × 9 mm, manche rond, 9 cm



H-4410

**Barraquer-Troutman**



Mikro-Nadelhalter, gerade, mit Sperre, 0.6 × 9 mm, runder Griff, 9 cm  
 Micro Needle holder, straight, with lock, 0.6 × 9 mm, round handle, 9 cm  
 Micro-Porta-aquija, recta, con cierre, 0.6 × 9 mm, con mango redondo, 9 cm  
 Micro-Porte-aiguille, droits, avec ressort, 0.6 × 9 mm, manche rond, 9 cm

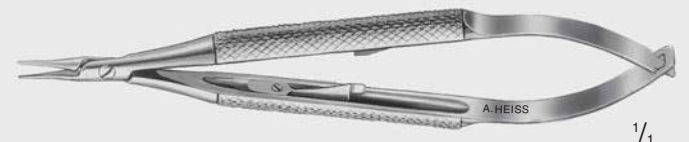

H-4415

**Barraquer-Troutman**



Mikro-Nadelhalter, gebogen, mit Sperre, 0.6 × 9 mm, runder Griff, 9 cm  
 Micro Needle holder, curved, with lock, 0.6 × 9 mm, round handle, 9 cm  
 Micro-Porta-aquija, curva, con cierre, 0.6 × 9 mm, con mango redondo, 9 cm  
 Micro-Porte-aiguille, courbes, avec ressort, 0.6 × 9 mm, manche rond, 9 cm



H-4420

**Castroviejo**



Mikro-Nadelhalter, gerade, 0.5 × 9 mm, ohne Sperre, 9 cm  
 Micro-Needle holder, straight, 0.5 × 9 mm, without lock, 9 cm  
 Micro-Porta-aguja, recta, 0.5 × 9 mm, sin cierre, 9 cm  
 Micro-Porte-aiguille, droits, 0.5 × 9 mm, sans ressort, 9 cm



H-4425

**Castroviejo**



Mikro-Nadelhalter, gebogen, 0.5 × 9 mm, ohne Sperre, 9 cm  
 Micro-Needle holder, curved, 0.5 × 9 mm, without lock, 9 cm  
 Micro-Porta-aguja, curva, 0.5 × 9 mm, sin cierre, 9 cm  
 Micro-Porte-aiguille, courbes, 0.5 × 9 mm, sans ressort, 9 cm



H-4430

**Castroviejo**

Mikro-Nadelhalter, gerade, 0.5 × 9 mm, mit Sperre, 9 cm  
Micro-Needle holder, straight, 0.5 × 9 mm, with lock, 9 cm  
Micro-Porta-aguja, recta, 0.5 × 9 mm, con cierre, 9 cm  
Micro-Porte-aiguille, droits, 0.5 × 9 mm, avec ressort, 9 cm

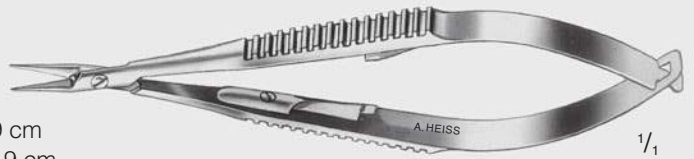

H-4435

**Castroviejo**

Mikro-Nadelhalter, gebogen, 0.5 × 9 mm, mit Sperre, 9 cm  
Micro-Needle holder, curved, 0.5 × 9 mm, with lock, 9 cm  
Micro-Porta-aguja, curva, 0.5 × 9 mm, con cierre, 9 cm  
Micro-Porte-aiguille, courbes, 0.5 × 9 mm, avec ressort, 9 cm

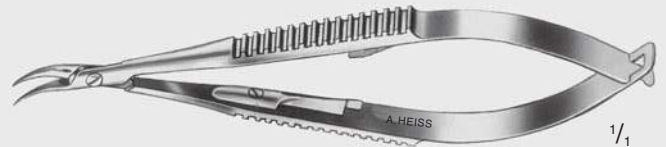

H-4440

**Troutman**

Mikro-Nadelhalter, gerade, mit Sperre, 0.7 × 9 mm, breiter Griff, 13 cm  
Micro-Needle holder, straight, with lock, 0.7 × 9 mm, wide handle, 13 cm  
Micro-Porta-aguja, recta, con cierre, 0.7 × 9 mm, mango ancho, 13 cm  
Micro-Porte-aiguille, droits, avec ressort, 0.7 × 9 mm, manche large, 13 cm



H-4441

**Troutman**

Mikro-Nadelhalter, gerade, ohne Sperre, 0.7 × 9 mm, breiter Griff, 13 cm  
Micro-Needle holder, straight, without lock, 0.7 × 9 mm, wide handle, 13 cm  
Micro-Porta-aguja, recta, sin cierre, 0.7 × 9 mm, mango ancho, 13 cm  
Micro-Porte-aiguille, droits, sans ressort, 0.7 × 9 mm, manche large, 13 cm



H-4450

**Castroviejo**

Mikro-Nadelhalter, gerade, 0.6 × 10 mm, ohne Sperre, 14 cm  
Micro-Needle holder, straight, 0.6 × 10 mm, without lock, 14 cm  
Micro-Porta-aguja, recta, 0.6 × 10 mm, sin cierre, 14 cm  
Micro-Porte-aiguille, droits, 0.6 × 10 mm, sans ressort, 14 cm



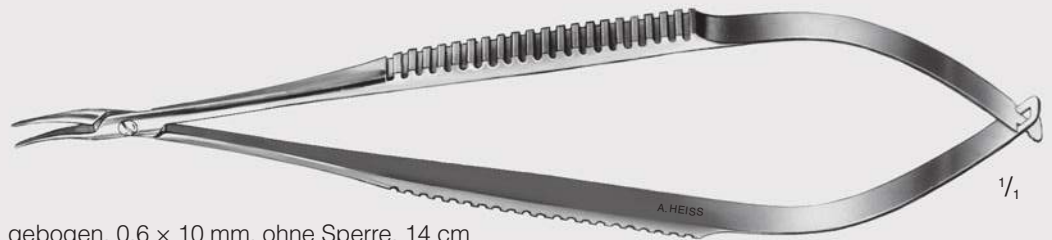

H-4455

**Castroviejo**

Mikro-Nadelhalter, gebogen, 0,6 × 10 mm, ohne Sperre, 14 cm  
 Micro-Needle holder, curved, 0,6 × 10 mm, without lock, 14 cm  
 Micro-Porta-aguja, curva, 0,6 × 10 mm, sin cierre, 14 cm  
 Micro-Porte-aiguille, courbes, 0,6 × 10 mm, sans ressort, 14 cm



neues NB

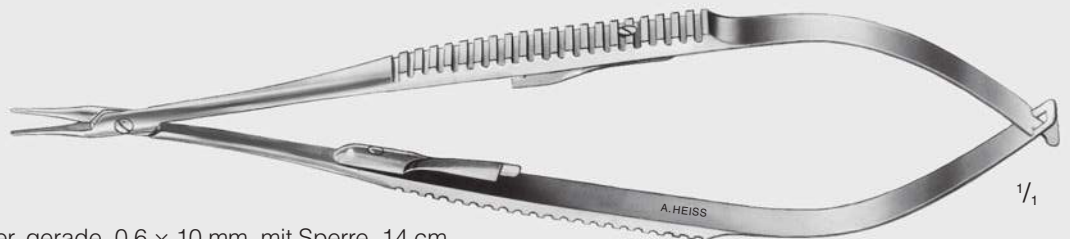

H-4460

**Castroviejo**

Mikro-Nadelhalter, gerade, 0,6 × 10 mm, mit Sperre, 14 cm  
 Micro-Needle holder, straight, 0,6 × 10 mm, with lock, 14 cm  
 Micro-Porta-aguja, recta, 0,6 × 10 mm, con cierre, 14 cm  
 Micro-Porte-aiguille, droits, 0,6 × 10 mm, avec ressort, 14 cm

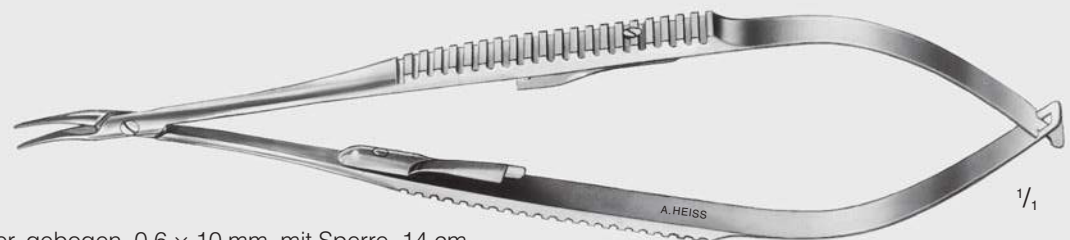

H-4465

**Castroviejo**

Mikro-Nadelhalter, gebogen, 0,6 × 10 mm, mit Sperre, 14 cm  
 Micro-Needle holder, curved, 0,6 × 10 mm, with lock, 14 cm  
 Micro-Porta-aguja, curva, 0,6 × 10 mm, con cierre, 14 cm  
 Micro-Porte-aiguille, courbes, 0,6 × 10 mm, avec ressort, 14 cm

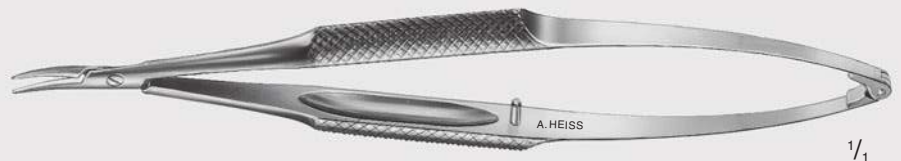

H-4560

Mikro-Nadelhalter, gebogen, 0,6 × 9 mm, ohne Sperre, 12 cm, mit besonders feiner Feder, mit Schraubverschluss  
 Micro-Needle holder, curved, 0,6 × 9 mm, without lock, 12 cm, with extra delicate spring, with screw lock  
 Micro-Porta-aguja, curva, 0,6 × 9 mm, sin cierre, 12 cm, con resorte extra delicado, con cierre roseado  
 Micro-Porte-aiguille, courbes, 0,6 × 9 mm, sans ressort, 12 cm, avec ressort très délicat, avec filet de vis



H-4562

**Troutman**

Mikro-Nadelhalter, gerade, 0,5 × 10 mm, ohne Sperre, 10 cm, mit besonders feiner Feder, mit Schraubverschluss  
 Micro-Needle holder, straight, 0,5 × 10 mm, without lock, 10 cm, with extra delicate spring, with screw lock  
 Micro-Porta-aguja, recta, 0,5 × 10 mm, sin cierre, 10 cm, con resorte extra delicado, con cierre roseado  
 Micro-Porte-aiguille, droits, 0,6 × 10 mm, sans ressort, 10 cm, avec ressort très délicat, avec filet de vis





**H-4563 Troutman**

Mikro-Nadelhalter, gebogen, 0.5 × 10 mm, ohne Sperre, 10 cm, mit besonders feiner Feder, mit Schraubverschluss  
Micro-Needle holder, curved, 0.5 × 10 mm, without lock, 10 cm, with extra delicate spring, with screw lock  
Micro-Porta-aguja, curva, 0.5 × 10 mm, sin cierre, 10 cm, con extra delicado resorte, con cierre roseado  
Micro-Porte-aiguille, courbes, 0.5 × 10 mm, sans ressort, 10 cm, avec ressort très délicat, avec filet de vis



**H-4565 Barraquer**

Mikro-Nadelhalter, gebogen, 0.6 × 10 mm, ohne Sperre, 12 cm mit besonders feiner Feder, mit Schraubverschluss  
Micro-Needle holder, curved, 0.6 × 10 mm, without lock, 12 cm, with extra delicate spring, with screw lock  
Micro-Porta-aguja, curva, 0.6 × 10 mm, sin cierre, 12 cm, con extra delicado resorte, con cierre roseado  
Micro-Porte-aiguille, courbes, 0.6 × 10 mm, sans ressort, 12 cm, avec ressort très délicat, avec filet de vis



**H-4566 Barraquer**



Mikro-Nadelhalter, gebogen, 0.7 × 10 mm, ohne Sperre, 12 cm, mit besonders feiner Feder, mit Schraubverschluss  
Micro-Needle holder, curved, 0.7 × 10 mm, without lock, 12 cm, with extra delicate spring, with screw lock  
Micro-Porta-aguja, curva, 0.7 × 10 mm, sin cierre, 12 cm, con extra delicado resorte, con cierre roseado  
Micro-Porte-aiguille, courbes, 0.7 × 10 mm, sans ressort, 12 cm, avec ressort très délicat, avec filet de vis



**H-4568 Barraquer**



Mikro-Nadelhalter, gebogen, 0.6 × 10 mm, ohne Sperre, 13 cm, mit besonders feiner Feder, mit Schraubverschluss  
Micro-Needle holder, curved, 0.6 × 10 mm, without lock, 13 cm, with extra delicate spring, with screw lock  
Micro-Porta-aguja, curva, 0.6 × 10 mm, sin cierre, 13 cm, con extra delicado resorte, con cierre roseado  
Micro-Porte-aiguille, courbes, 0.6 × 10 mm, sans ressort, 13 cm, avec ressort très délicat, avec filet de vis



**H-4569 Barraquer**



Mikro-Nadelhalter, gebogen, 0.7 × 10 mm, ohne Sperre, 13 cm, mit besonders feiner Feder, mit Schraubverschluss  
Micro-Needle holder, curved, 0.7 × 10 mm, without lock, 13 cm, with extra delicate spring, with screw lock  
Micro-Porta-aguja, curva, 0.7 × 10 mm, sin cierre, 13 cm, con extra delicado resorte, con cierre roseado  
Micro-Porte-aiguille, courbes, 0.7 × 10 mm, sans ressort, 13 cm, avec ressort très délicat, avec filet de vis



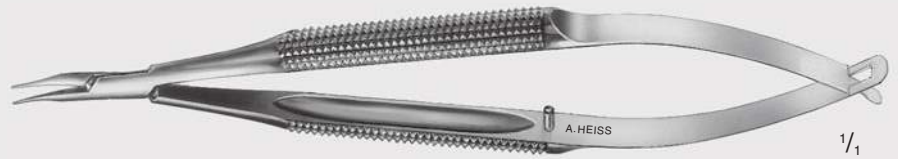

**H-4572**

**Barraquer**

Mikro-Nadelhalter, gebogen, 0,6 × 10 mm, ohne Sperre, 11,5 cm  
 Micro-Needle holder, curved, 0,6 × 10 mm, without lock, 11,5 cm,  
 Micro-Porta-aguja, curva, 0,6 × 10 mm, sin cierre, 11,5 cm  
 Micro-Porte-aiguille, courbes, 0,6 × 10 mm, sans ressort, modèle court, 11,5 cm

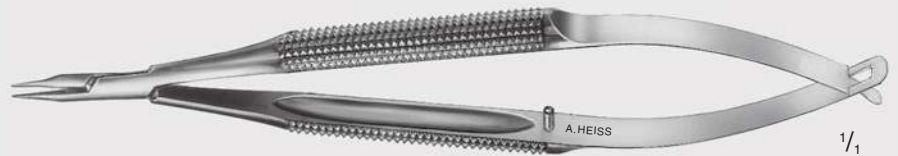

**H-4572B**

**Barraquer**

Mikro-Nadelhalter, gerade, 0,6 × 10 mm, ohne Sperre, 11,5 cm  
 Micro-Needle holder, straight, 0,6 × 10 mm, without lock, 11,5 cm,  
 Micro-Porta-aguja, recta, 0,6 × 10 mm, sin cierre, 11,5 cm  
 Micro-Porte-aiguille, droits, 0,6 × 10 mm, sans ressort, modèle court, 11,5 cm



**H-4572A**

**Barraquer**

Mikro-Nadelhalter, gebogen, 0,6 × 10 mm, mit Sperre, 11,5 cm  
 Micro-Needle holder, curved, 0,6 × 10 mm, with lock, 11,5 cm,  
 Micro-Porta-aguja, curva, 0,6 × 10 mm, con cierre, 11,5 cm  
 Micro-Porte-aiguille, courbes, 0,6 × 10 mm, avec ressort, modèle court, 11,5 cm



**H-4572AB**

**Barraquer**

Mikro-Nadelhalter, gerade, 0,6 × 10 mm, mit Sperre, 11,5 cm  
 Micro-Needle holder, straight, 0,6 × 10 mm, with lock, 11,5 cm,  
 Micro-Porta-aguja, recta, 0,6 × 10 mm, con cierre, 11,5 cm  
 Micro-Porte-aiguille, droits, 0,6 × 10 mm, avec ressort, modèle court, 11,5 cm



Mikro-Nadelhalter  
 Micro-Needle holder  
 Micro-Porta-aguja  
 Micro-Porte-aiguille



**H-4555A**

gebogen, 0,5 mm, ohne Sperre, 12,5 cm  
 curved, 0,5 mm, without lock, 12,5 cm  
 curva, 0,5 mm, sin cierre, 12,5 cm  
 courbes, 0,5 mm, sans ressort, 12,5 cm

**H-4555B**

gebogen, 0,5 mm, mit Sperre, 0,5 mm, 12,5 cm  
 curved, 0,5 mm, with lock, 12,5 cm  
 curva, 0,5 mm, con cierre, 12,5 cm  
 courbes, 0,5 mm, avec ressort, 12,5 cm



**H-4573A McPherson**



Nadelhalter, 0.8 mm, gerade, mit Sperre, 10.5 cm  
Needle holder 0.8 mm, straight, with lock, 10.5 cm  
Porta-Aguja, 0.8 mm, recta, con cierre, 10.5 cm  
Porte-aiguille, 0.8 mm, droits, avec ressort, 10.5 cm

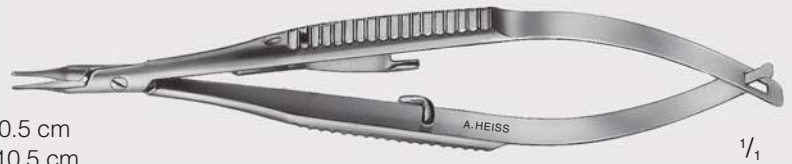

**H-4573B McPherson**



Nadelhalter, 0.8 mm, gerade, ohne Sperre, 10.5 cm  
Needle holder 0.8 mm, straight, without lock, 10.5 cm  
Porta-Aguja, 0.8 mm, recta, sin cierre, 10.5 cm  
Porte-aiguille, 0.8 mm, droits, sans ressort, 10.5 cm

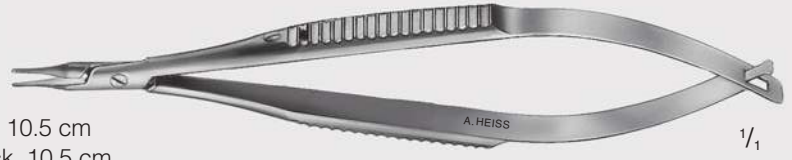

**H-4574A McPherson**



Nadelhalter, 0.8 mm, gebogen, mit Sperre, 10.5 cm  
Needle holder 0.8 mm, curved, with lock, 10.5 cm  
Porta-Aguja, 0.8 mm, curva, con cierre, 10.5 cm  
Porte-aiguille, 0.8 mm, courbes, avec ressort, 10.5 cm



**H-4574B McPherson**



Nadelhalter, 0.8 mm, gebogen, ohne Sperre, 10.5 cm  
Needle holder 0.8 mm, curved, without lock, 10.5 cm  
Porta-Aguja, 0.8 mm, curva, sin cierre, 10.5 cm  
Porte-aiguille, 0.8 mm, courbes, sans ressort, 10.5 cm



**H-4575 Barraquer**



Mikro-Nadelhalter, gebogen, Standard Modell, 1.0 x 10 mm, ohne Sperre, 13 cm  
Micro-Needle holder, curved, standard model, 1.0 x 10 mm, without lock, 13 cm  
Micro-Porta-aguja, curva, modelo clásico, 1.0 x 10 mm, sin cierre, 13 cm  
Micro-Porte-aiguille, courbes, modèle classique, 1.0 x 10 mm, sans ressort, 13 cm

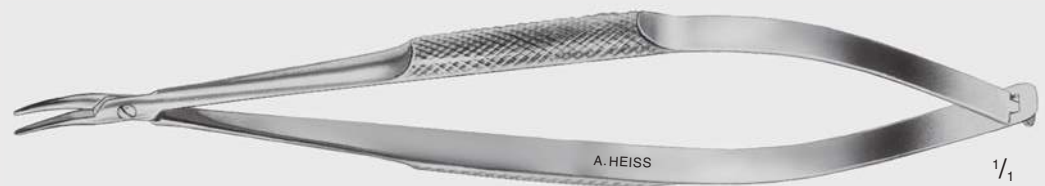

**H-4576 Barraquer**



Mikro-Nadelhalter, gebogen, Standard Modell, 1.0 x 10 mm, mit Sperre, 13 cm  
Micro-Needle holder, curved, standard model 1.0 x 10 mm, with lock, 13 cm  
Micro-Porta-aguja, curva, modelo clásico, 1.0 x 10 mm, con cierre, 13 cm  
Micro-Porte-aiguille, courbes, modèle classique, 1.0 x 10 mm, avec ressort, 13 cm

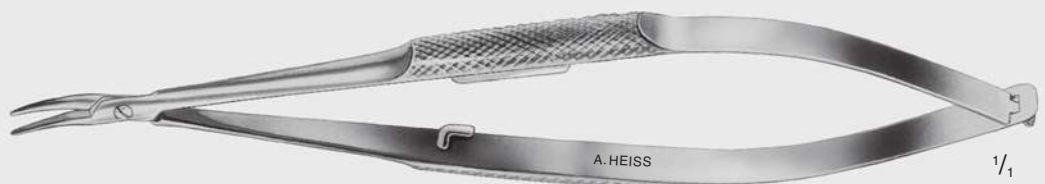

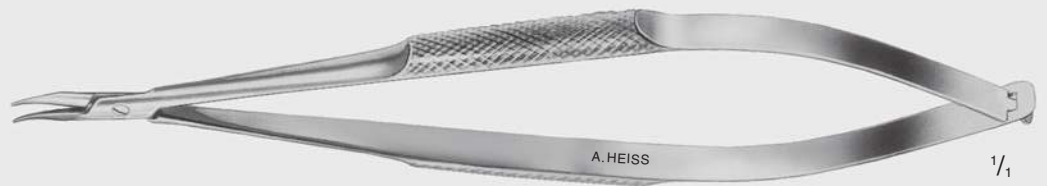

H-4578

**Barraquer**



Mikro-Nadelhalter, gebogen, extra feines Maul, 0.6 × 10 mm, ohne Sperre, 13 cm  
 Micro-Needle holder, curved, extra delicate jaws, 0.6 × 10 mm, without lock, 13 cm  
 Micro-Porta-aguja, curva, boca extra delicada, 0.6 × 10 mm, sin cierre, 13 cm  
 Micro-Porte-aiguille, courbes, spécial délicate bouche, 0.6 × 10 mm, sans ressort, 13 cm

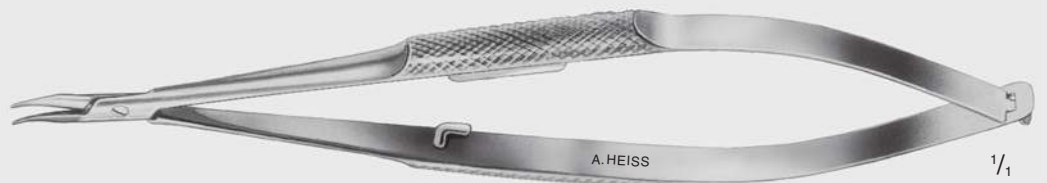

H-4579

**Barraquer**



Mikro-Nadelhalter, gebogen, extra feines Maul, 0.6 × 10 mm, mit Sperre, 13 cm  
 Micro-Needle holder, curved, extra delicate jaws, 0.6 × 10 mm, with lock, 13 cm  
 Micro-Porta-aguja, curva, boca extra delicada, 0.6 × 10 mm, con cierre, 13 cm  
 Micro-Porte-aiguille, courbes, spécial délicate bouche, 0.6 × 10 mm, avec ressort, 13 cm



H-4577

**Troutman-Barraquer**



Mikro-Nadelhalter, abgewinkelt, ohne Sperre, 11.5 cm  
 Micro-Needle holder, angled, without lock, 11.5 cm  
 Micro-Porta-aguja, acodada, sin cierre, 11.5 cm  
 Micro-Porte-aiguille, coudé, sans ressort, 11.5 cm

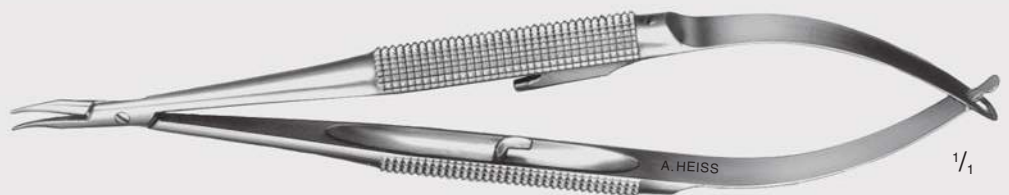

H-4579A

**Barraquer**



Mikro-Nadelhalter, gebogen, 0.5 × 9 mm Maulteile, mit Sperre, 12.5 mm  
 Micro-Needle holder, curved, 0.5 × 9 mm jaws, with lock, 12.5 cm,  
 Micro-Porta-aguja, curva, boca 0.5 × 9 mm, con cierre, 12.5 cm  
 Micro-Porte-aiguille, courbe, spécial délicate bouche 0.5 × 9 mm, avec ressort, 12.5 cm



H-4579B

**Barraquer**



Mikro-Nadelhalter, gebogen, 0.5 × 9 mm Maulteile, ohne Sperre, 12.5 mm  
 Micro-Needle holder, curved, 0.5 × 9 mm jaws, without lock, 12.5 cm  
 Micro-Porta-aguja, curva, boca 0.5 × 9 mm, sin cierre, 12.5 cm  
 Micro-Porte-aiguille, courbe, spécial délicate bouche 0.5 × 9 mm, sans ressort, 12.5 cm



**H-4500** Arruga  
Nadelhalter, gerade, mit Sperre, 14 cm  
Needle holder, straight, with lock, 14 cm  
Porta-aguja, recta, con cierre, 14 cm  
Porte-aiguille, droits, avec ressort, 14 cm

1/1



**H-4501** Arruga  
Nadelhalter, gebogen, mit Sperre, 14 cm  
Needle holder, curved, with lock, 14 cm  
Porta-aguja, curva, con cierre, 14 cm  
Porte-aiguille, courbes, avec ressort, 14 cm

1/1



**H-4510** Kalt  
Nadelhalter, gerade, 14 cm  
Needle holder, straight, 14 cm  
Porta-aguja, recta, 14 cm  
Porte-aiguille, droits, 14 cm

1/1

**H-4520** Kalt  
Nadelhalter, gebogen, 14 cm  
Needle holder, curved, 14 cm  
Porta-aguja, curva, 14 cm  
Porte-aiguille, courbes, 14 cm



**H-4550** Paton  
Nadelhalter, gerade, 11.5 cm  
Needle holder, straight, 11.5 cm  
Porta-aguja, recta, 11.5 cm  
Porte-aiguille, droits, 11.5 cm

1/1

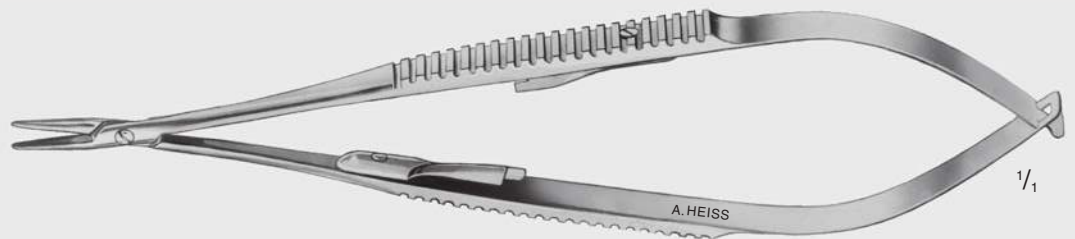

**H-4580**    **Castroviejo**  
Nadelhalter, gerade, 1.0 × 11 mm, mit Sperre, 14 cm  
Needle holder, straight, 1.0 × 11 mm, with lock, 14 cm  
Porta-aguja, recta, 1.0 × 11 mm, con cierre, 14 cm  
Porte-aiguille, droits, 1.0 × 11 mm, avec ressort, 14 cm

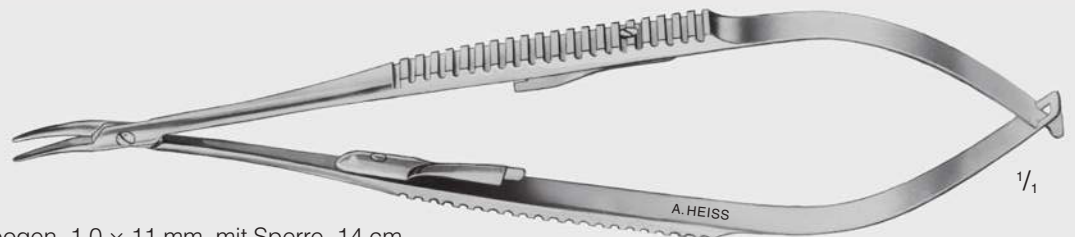

**H-4580A**    **Castroviejo**  
Nadelhalter, gebogen, 1.0 × 11 mm, mit Sperre, 14 cm  
Needle holder, curved, 1.0 × 11 mm, with lock, 14 cm  
Porta-aguja, curva, 1.0 × 11 mm, con cierre, 14 cm  
Porte-aiguille, courbes, 1.0 × 11 mm, avec ressort, 14 cm

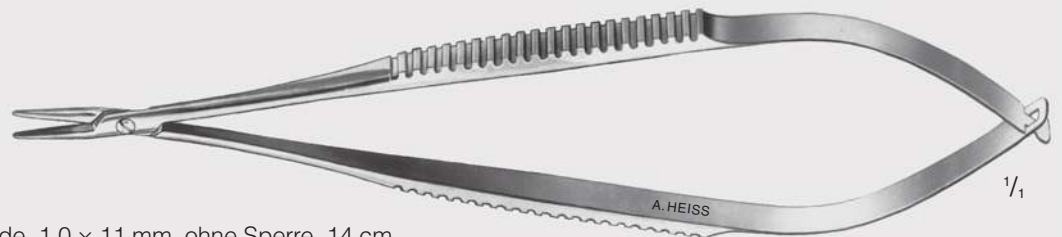

**H-4581**    **Castroviejo**  
Nadelhalter, gerade, 1.0 × 11 mm, ohne Sperre, 14 cm  
Needle holder, straight, 1.0 × 11 mm, without lock, 14 cm  
Porta-aguja, recta, 1.0 × 11 mm, sin cierre, 14 cm  
Porte-aiguille, droits, 1.0 × 11 mm, sans ressort, 14 cm



**H-4581A**    **Castroviejo**  
Nadelhalter, gebogen, 1.0 × 11 mm, ohne Sperre, 14 cm  
Needle holder, curved, 1.0 × 11 mm, without lock, 14 cm  
Porta-aguja, curva, 1.0 × 11 mm, sin cierre, 14 cm  
Porte-aiguille, courbes, 1.0 × 11 mm, sans ressort, 14 cm









# 8

... Tränenweg Instrumente | Verschiedene Instrumente  
... Lachrymal Instruments | Miscellaneous Instruments  
... Instrumentos para Lacrimal | Instrumentos Diversos  
... Instruments voies lacrymales | Instruments divers  
...



**H-2735**    **Kellnar**  
 Trabekular-Sonde, rechts  
 Trabecular probe, right  
 Estilete trabeculares, derecho  
 Trabéculotome, á droite



**H-2736**    **Kellnar**  
 Trabekular-Sonde, links  
 Trabecular probe, left  
 Estilete trabeculares, izquierdo  
 Trabéculotome, á gauche

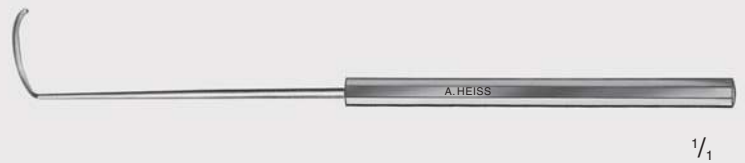

**H-2745**    **Harms**  
 Trabekular-Sonde, rechts  
 Trabecular probe, right  
 Estilete trabeculares, derecho  
 Trabéculotome, á droite



**H-2746**    **Harms**  
 Trabekular-Sonde, links  
 Trabecular probe, left  
 Estilete trabeculares, izquierdo  
 Trabéculotome, á gauche



**H-2750**    **Mackensen**  
 Trabekular-Sonde, rechts  
 Trabecular probe, right  
 Estilete trabeculares, derecho  
 Trabéculotome, á droite



**H-2751**    **Mackensen**  
 Trabekular-Sonde, links  
 Trabecular probe, left  
 Estilete trabeculares, izquierdo  
 Trabéculotome, á gauche



### Bowman

Augensonde, Edelstahl  
Lachrymal probe, stainless steel  
Estilete lacrimal, acero inoxidable  
Stylet lacrymal, acier inoxydable

zylindrisch : cilindrico  
cylindrical : cylindrique

geknöpft : olivar  
bulbous : olivaire



1/1



1/1

Fig.

Fig.

zylindrisch	0000 – 000	<b>H-2802/1</b>
cylindrical	000 – 00	<b>H-2802/2</b>
cilindrico	00 – 0	<b>H-2802/3</b>
cylindrique	0 – 1	<b>H-2802/4</b>
	1 – 2	<b>H-2802/5</b>
	2 – 3	<b>H-2802/6</b>
	3 – 4	<b>H-2802/7</b>
	4 – 5	<b>H-2802/8</b>
	5 – 6	<b>H-2802/9</b>
	7 – 8	<b>H-2802/10</b>

geknöpft	0000 – 000	<b>H-2812/1</b>
bulbous	000 – 00	<b>H-2812/2</b>
olivar	00 – 0	<b>H-2812/3</b>
olivaire	0 – 1	<b>H-2812/4</b>
	1 – 2	<b>H-2812/5</b>
	2 – 3	<b>H-2812/6</b>
	3 – 4	<b>H-2812/7</b>
	4 – 5	<b>H-2812/8</b>
	5 – 6	<b>H-2812/9</b>
	7 – 8	<b>H-2812/10</b>



1/1

### H-2830 Catalano

Tränenweg Intubations-Set, 0.7 × 140 mm  
Lachrymal Intubation Set, 0.7 × 140 mm  
Set de intubación para lacrimal, 0.7 × 140 mm  
Jeu pour conduits lacrymaux, 0.7 × 140 mm

### H-2835 Crawford

Haken : Gancho  
Retrieving Hook : Crochet



3/4



### H-2836 Crawford

Tränenweg Intubations-Set : Set de intubación para lacrimal  
Lachrymal intubation set : Jeu pour conduits lacrymaux

1/1

**H-2840 Rolf**

Tränensacksonde  
Probe for lachrymal sac  
Estilete para el saco lacrimal  
Stylet pour le sac lacrymal



1/1

**H-2829 Wright**

Fasziennadel, 130 mm  
Fascia needle, 130 mm  
Aguja de vendaje, 130 mm  
Aiguille pour sutures  
aponévrotiques, 130 mm



mit Öhr 1.0 mm × 6.0 mm  
with eye 1.0 × 6.0 mm  
con ojo de 1.0 × 6.0 mm  
avec trou 1.0 × 6.0 mm

1/1



Pigtail-Sonde  
Pigtail probe  
Pigtail estilete lacrimal  
Stylet lacrymal

**H-2815**

mit Haken  
with hook    con gancho  
avec crochet

1/1

**H-2816**

mit Öhr, 0,3 mm  
with eye, 0.3 mm    con ojos de 0.3 mm  
avec trou, 0.3 mm

**Wilder**

Dilatator für den Tränenkanal  
Lachrymal dilator  
Dilatador para el canal lacrimal  
Dilatateur pour voies lacrymales

Fig. 0



Fig. 1



Fig. 2



Fig. 3



1/1

**H-2850/0**

Fig. 0

**H-2850/1**

Fig. 1

**H-2850/2**

Fig. 2

**H-2850/3**

Fig. 3

**H-2851**

Dilatator für den Tränenkanal, kurz  
Lachrymal dilator, short  
Dilatador para el canal lacrimal, corto  
Dilatateur pour voies lacrymales, court

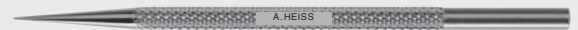

1/1

**H-2855**

**Castroviejo**

Dilatator für den Tränenkanal, doppelt  
Lachrymal dilator, double end  
Dilatador para el canal lacrimal, doble  
Dilatateur pour voies lacrymales, double



1/1

H-2875

Dilatator für den Tränenkanal, Modell Gießen  
Lachrymal dilator, Gießen model  
Dilatador para el canal lacrimal, modelo Gießen  
Dilatateur pour voies lacrymales, modèle Gießen



1/1

**Sichel-Wilder**

Dilatator für den Tränenkanal  
Lachrymal dilator  
Dilatador para el canal lacrimal  
Dilatateur pour voies lacrymales

H-2857/1

Fig. 1

H-2857/2

Fig. 2

H-2857/3

Fig. 3



1/1

**Citelli**

Knochenstanze  
Rongeur  
Pinza-gubia  
Emporte-pièce

H-2900/1 2 mm

H-2900/2 3 mm

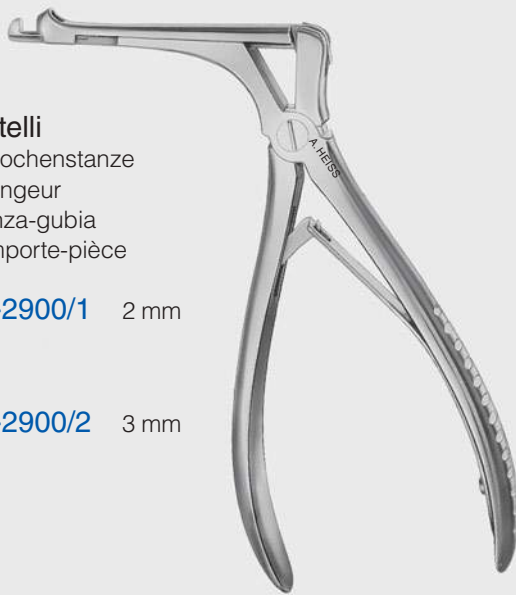

1/2

**Beyer**

Knochenstanze, fein  
Atticus punch, delicate  
Pinza-gubia, fina  
Emporte-pièce, fine

H-2902



1/2

**Kerrison**

Knochenstanze  
Atticus punch  
Pinza-gubia  
Emporte-pièce

H-2905/0 3.2 mm

H-2905/1 4 mm

H-2905/2 5 mm

H-2905/3 6.2 mm



1/2

**H-1630**

**Rollet**

Meißel für den Tränensack  
Rugine for lachrymal sack  
Cinzel para el saco lacrimal  
Rugine pour le sac lacrymal

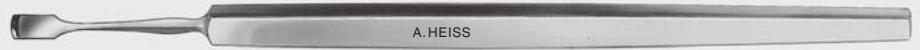

1/1

**H-2920**

**West**

Flachmeißel für den Tränensack, 5.4 mm  
Bone chisel for lachrymal sack, 5.4 mm  
Cinzel para, para el saco lacrimal, 5.4 mm  
Ciseau-burin pour le sac lacrymal, 5.4 mm

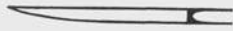

1/1

**H-2922**

**West**

Hohlmeißel für den Tränensack  
Bone gouge for lachrymal sack  
Gubia para el saco lacrimal  
Gouge pour le sac lacrymal

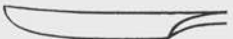

1/1

**H-2926**

**Freer**

Flachmeißel für den Tränensack, 4.7 mm  
Bone chisel for lachrymal sack, 4.7 mm  
Cinzel para el saco lacrimal, 4.7 mm  
Ciseau-burin pour le sac lacrymal, 4.7 mm



1/1

**H-2930**

**Mead**

Hammer  
Mallet  
Martillo  
Maillet



2/3

**H-2930A**

Ersatzbacken, Paar  
Spare facing, pair  
Tapas de repuesto, par  
Paire d'embouts maillet de rechange

H-2910

**Friedmann**

Hohlmeisselzange, 14.5 cm  
Rongeur, 14.5 cm  
Pinza Gubia, 14.5 cm  
Gouge coudée, 14.5 cm



1/1



1/1

**Hartmann-Halle**

Nasenspekulum  
Nasal speculum  
Espéculo nasal  
Spéculum nasal

H-2915/1

klein  
small

pequeño  
petit



1/1

H-2915/2

mittel  
medium

mediano  
moyen



1/1

H-2915/3

groß  
large

grande  
grand



1/1





**H-2950**    **Carter**  
 Halte- und Implantationspinzette für Enucleationsplomben  
 Sphere introducer  
 Pinzas para poner un empaste de enucleación  
 Pince d'implantation pour plombes d'énucléation

1/1

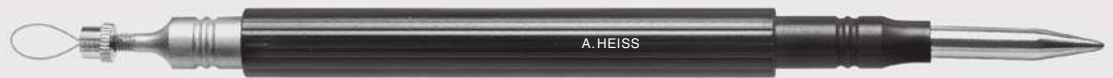

**H-1790**    Fremdkörperschlinge und Magnet in Umsteckhülse  
 Foreign-body remover and magnetic eye probe in reversible handle  
 Asa e imán para cuerpos extraños con mango de metal reversible  
 Anse pour corps étrangers et aimant rentrant dans le manche métal

1/1

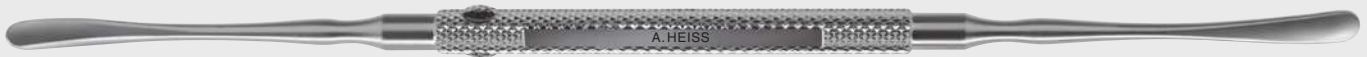

**H-2928**    **Freer**  
 Doppelelevator, scharf und stumpf  
 Twin elevator, sharp and blunt  
 Disector y elevador  
 Elévateur double, tranchant et mousse

2/3

**H-2940**    Skleraschutz, klein, 20 mm x 28 mm, Paar, Edelstahl  
 Scleral shield, small, 20 mm x 28 mm, pair, stainless steel  
 Protector, pequeño, inoxidable, 20 mm x 28 mm, un par  
 Coques, petites, 20 mm x 28 mm, pair

**H-2941**    Skleraschutz, gross, 22 mm x 30 mm, Paar, Edelstahl  
 Scleral shield, big, 22 mm x 30 mm, pair, stainless steel  
 Protector, largo, inoxidable, 22 mm x 30 mm, un par  
 Coques, grandes, 22 mm x 30 mm, pair



**H-2942**    Skleraschutz, Set: klein / gross  
 Scleral shield, set: small / big  
 Protector, set: pequeño / largo  
 Coques, set: petites / grandes

1/1

**H-2982**    **Holth**  
 Kapselstanze  
 Capsular punch  
 Punzón Capsula  
 Emporte-pièce capsulaire



1/1

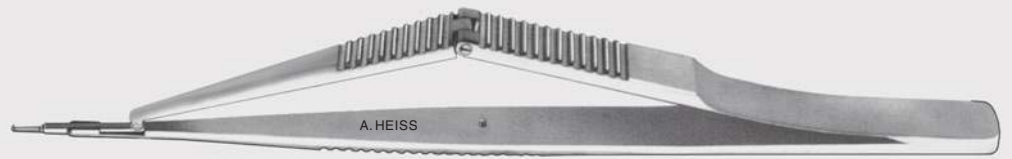

**H-2983 Kelly**

Descemet's Membranstanze, 1 mm x 0.75 mm  
Descemet's membrane punch, 1 mm x 0.75 mm  
Sacabocado, 1 mm x 0.75 mm  
Punch descemet, 1 mm x 0.75 mm

1/1

**H-2985 Gass**

Corneaskleralstanze, 1,5 mm  
Corneoscleral punch, 1,5 mm  
Punzón, 1,5 mm  
Punch, 1,5 mm



1/1



**H-2986**

Mikro Glaucomstanze, 0.9 mm / 20 ga, 0.3 mm  
Micro trabeculectomy punch, 0.9 mm / 20 ga, 0.3 mm  
Micro punzón para trabeculectomía, 0.9 mm / 20 ga, 0.3 mm  
Punch trabeculectomie, 0.9 mm / 20 ga, 0.3 mm

1/1



**H-2984**

**Luntz-Dodick**

Glaukomstanze 0.5 mm  
Trabeculectomy punch, 0,5 mm  
Punzón para trabeculectomía, 0,5 mm  
Punch trabeculectomie, 0,5 mm

1/1

**H-2984A**

Ersatzstanzenkopf für H-2984  
Replacement cutting head for H-2984  
Punta de recambio  
Punch de rechange pour H-2984



1/1

**H-7150**    **Algerbrush**  
 Corneafräse mit 1.0 mm Bohrer  
 Rust ring remover with 1.0 mm burr  
 Removedor de anillo de óxido con fresa de 1.0 mm  
 Fraise cornéenne avec fraise de 1.0 mm

**H-7153**    1.0 mm Bohrer, Packung á 5 Stück, unsteril  
 1.0 mm burr, box of 5 pcs., non-sterile  
 Fresa de reemplazo para cepillo Algerbrusch de 1.0mm, caja de 5 unidades  
 Fraise de 1.0 mm, box avec 5 pieces

**H-7151**    **Algerbrush**  
 Corneafräse mit 0.5 mm Bohrer  
 Rust ring remover with 0.5 mm burr  
 Removedor de anillo de óxido con fresa de 0.5 mm  
 Fraise cornéenne avec fraise de 0,5 mm

**H-7152**    0.5 mm Bohrer, Packung á 5 Stück, unsteril  
 0.5 mm burr, box of 5 pcs., non-sterile  
 Fresa de reemplazo para cepillo Algerbrusch de 1.0mm, caja de 5 unidades  
 Fraise de 0.5 mm, box avec 5 pieces

**H-7154**    **Algerbrush**  
 Pterygiumfräse mit 3.5 mm Bohrer  
 Pterygium instrument with 3.5 mm burr  
 Instrumento para pterygium, con fresa de 3.5 mm  
 Instrument pour ptérygion avec fraise de 3.5 mm



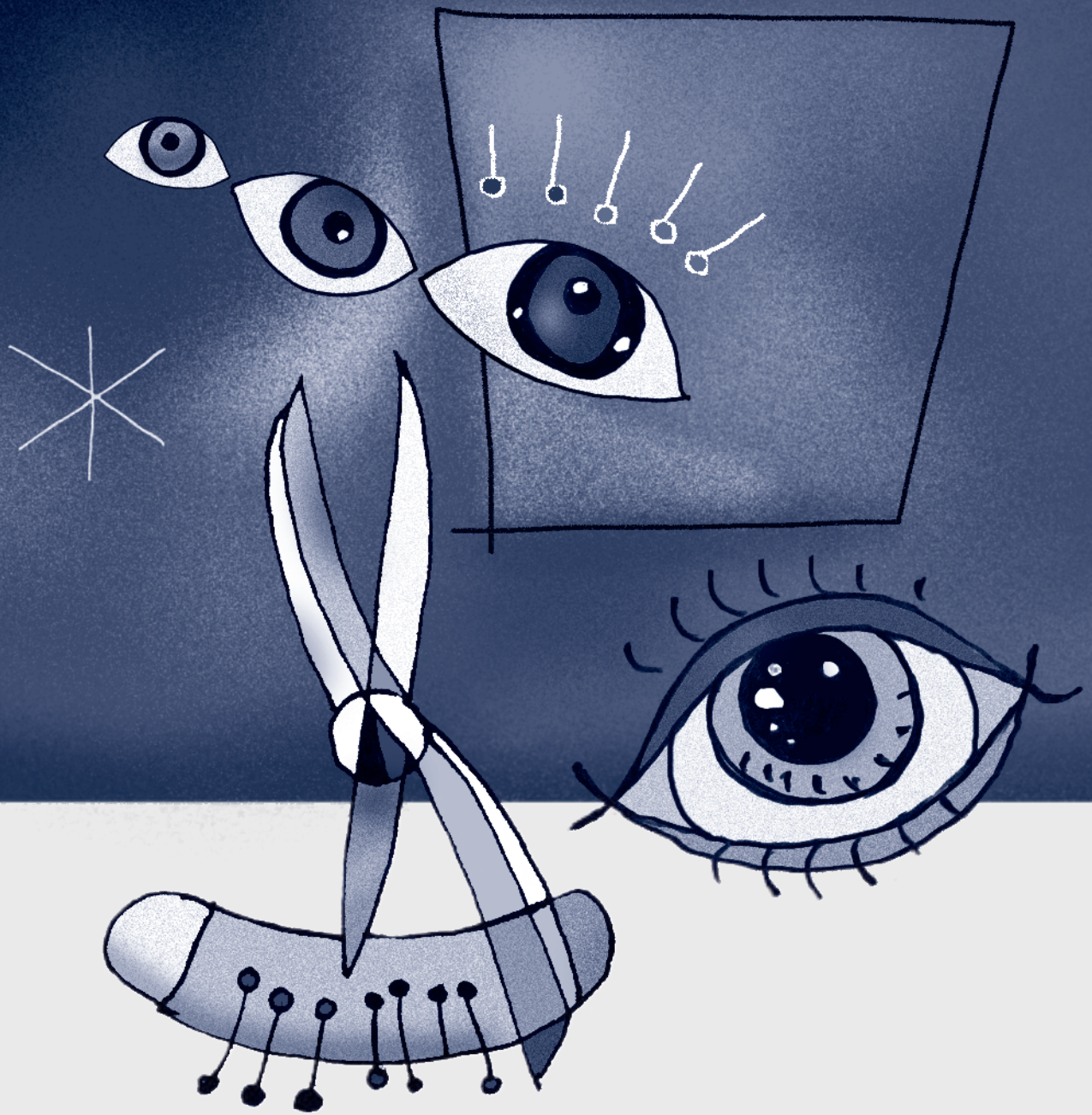

# 9

..... Mess- & Markierinstrumente  
..... Measuring & Marking Instruments  
..... Compás y Marcadores  
..... Compas et Marqueurs  
.....

**H-2630**    **Castroviejo**  
Zirkel, 15 mm  
Caliper, 15 mm  
Compás, 15 mm  
Compas, 15 mm



1/1

**H-2631**    **Castroviejo**  
Zirkel, 20 mm, gerade  
Caliper, 20 mm, straight  
Compás, 20 mm, recto  
Compas, 20 mm, droit



1/1

**H-2631A**    **Castroviejo**  
Zirkel, 20 mm, gebogen  
Caliper, 20 mm, curved  
Compás, 20 mm, curva  
Compas, 20 mm, courbes

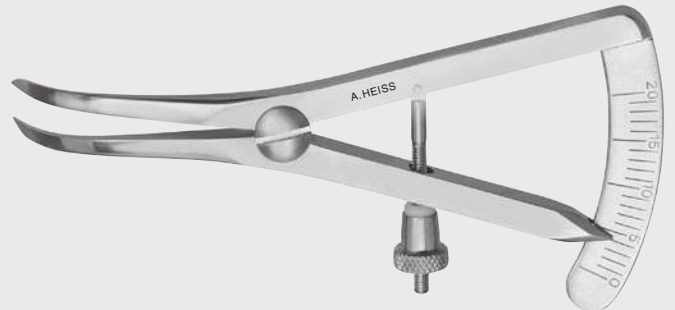

1/1

**H-2637**    **Castroviejo**  
Zirkel, 20 mm, gerade, 0.5 mm Teilung  
Caliper, 20 mm, straight, 0.5 mm graduation  
Compás, 20 mm, recto, graduación 0.5 mm  
Compas, 20 mm, droit, graduation de 0.5 mm

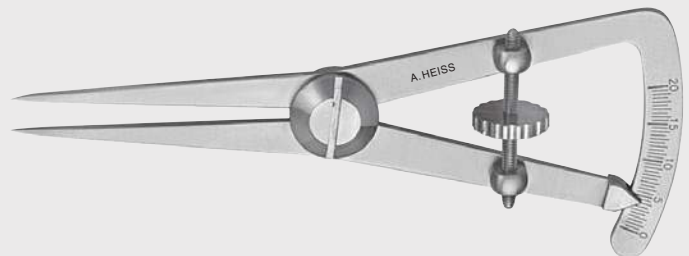

1/1

H-2632

**Osher**

Inzisionszirkel, 1 – 10 mm  
Incision caliper, 1 – 10 mm  
Compás para incisión, 1 – 10 mm  
Compas pour incision, 1 – 10 mm

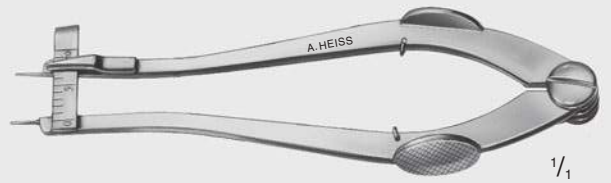

H-2670

**Braunstein**

Limbusmarker 3.0 / 3.5 mm  
Marker, 3.0 / 3.5 mm  
Marcador, 3.0 / 3.5 mm  
Marqueur, 3.0 / 3.5 mm



H-2670A

**Braunstein**

IVT Limbusmarker 4.0 / 3.5 mm  
IVT Marker, 4.0 / 3.5 mm  
Marcador IVT, 4.0 / 3.5 mm  
Marqueur IVT, 4.0 / 3.5 mm

1/1

H-2633

**Jameson**

Markierer, 80 mm  
Caliper, 80 mm  
Compás, 80 mm  
Pied à coulisse, 80 mm

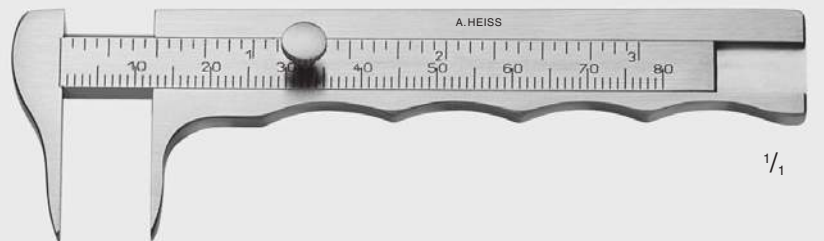

H-2620

**Masstab, biegsam, aus rostfreiem Stahl**

Flexible rule, stainless steel  
Reglilla flexible, inoxidable  
Règle flexible, inoxyidable

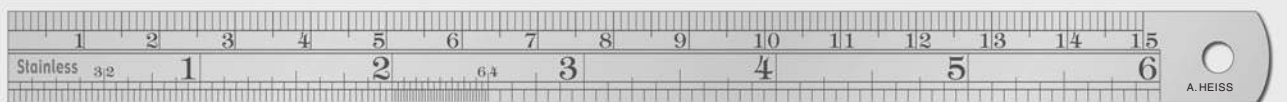

1/1



**Hoffer**

Hornhautmarkierer mit Fadenkreuz  
 Corneal marker with cross hairs  
 Marcador para la córnea, con retículo  
 Anneaux marqueur avec croix de centrage



1/1

<b>H-2610/1</b>	3.0 mm	<b>H-2610/8</b>	4.75 mm
<b>H-2610/2</b>	3.25 mm	<b>H-2610/9</b>	5.0 mm
<b>H-2610/3</b>	3.5 mm	<b>H-2610/10</b>	5.5 mm
<b>H-2610/4</b>	3.75 mm	<b>H-2610/11</b>	6.0 mm
<b>H-2610/5</b>	4.0 mm	<b>H-2610/12</b>	7.0 mm
<b>H-2610/6</b>	4.25 mm	<b>H-2610/13</b>	8.0 mm
<b>H-2610/7</b>	4.5 mm	<b>H-2610/14</b>	9.0 mm

**Bores**

Hornhautmarkierer  
 Corneal marker  
 Marcador para la córnea  
 Anneaux marqueur



1/1

<b>H-2611/1</b>	3.0 mm	<b>H-2611/8</b>	4.75 mm
<b>H-2611/2</b>	3.25 mm	<b>H-2611/9</b>	5.0 mm
<b>H-2611/3</b>	3.5 mm	<b>H-2611/10</b>	6.0 mm
<b>H-2611/4</b>	3.75 mm	<b>H-2611/11</b>	7.0 mm
<b>H-2611/5</b>	4.0 mm	<b>H-2611/12</b>	8.0 mm
<b>H-2611/6</b>	4.25 mm	<b>H-2611/13</b>	9.0 mm
<b>H-2611/7</b>	4.5 mm	<b>H-2611/14</b>	9.5 mm



1/1

**H-2612**

**Hoffer**

Hornhautmarkierer mit Fadenkreuz, 8.0 / 9.0 mm  
 Corneal marker with cross hairs, 8.0 / 9.0 mm  
 Marcador para la córnea, con retículo, 8.0 / 9.0 mm  
 Anneaux marqueur avec croix de centrage, 8.0 / 9.0 mm

**H-2613**

**Bores**

Hornhautmarkierer  
 Corneal marker  
 Marcador para la córnea  
 Anneaux marqueur



1/1

H-2605

**Mendez**  
 Messring  
 Measuring ring  
 Anillo de medición  
 Marqueur par degré



1/1

H-2606

**Bores**  
 Hornhautmarkierer  
 Corneal marker  
 Marcador para la córnea  
 Marqueur pour la cornée



1/1

**Thornton**  
 Hornhautmarkierer  
 Corneal marker  
 Marcador para la córnea  
 Marqueur pour la cornée



1/1

H-2636/1

4 Klängen  
 4 Blades  
 4 Hojas  
 4 Lames

H-2636/2

6 Klängen  
 6 Blades  
 6 Hojas  
 6 Lames

H-2636/3

8 Klängen  
 8 Blades  
 8 Hojas  
 8 Lames

H-2636/4

12 Klängen  
 12 Blades  
 12 Hojas  
 12 Lames

H-2636/5

16 Klängen  
 16 Blades  
 16 Hojas  
 16 Lames

**Anis**

Hornhautmarkierer  
 Corneal marker  
 Marcador para la córnea  
 Marqueur pour la cornée



1/1

H-2635/0

6 Klängen  
 6 Blades  
 6 Hojas  
 6 Lames

H-2635/1

8 Klängen  
 8 Blades  
 8 Hojas  
 8 Lames

H-2635/2

12 Klängen  
 12 Blades  
 12 Hojas  
 12 Lames

H-2635/3

16 Klängen  
 16 Blades  
 16 Hojas  
 16 Lames

H-2640

**Anis**  
 Nahtmarkierer, 8 Klängen  
 Suture marker, 8 blades  
 Marcador para sutura, 8 hojas  
 Marqueur, 8 lames



1/1

H-2645

**Chayet**

LASIK Hornhautmarkierer  
 LASIK Corneal marker  
 Marcador corneal aplicación LASIK  
 LASIK marqueur pour la cornée



1/1

H-2646

**Mendez**

LASIK Hornhautmarkierer  
 LASIK Corneal marker  
 Marcador corneal aplicación LASIK  
 LASIK marqueur pour la cornée

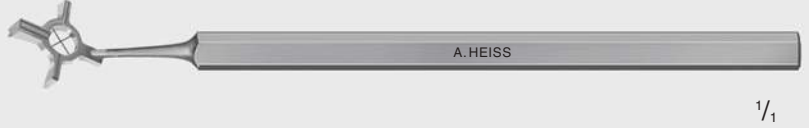

1/1

H-2647

**Lu**

LASIK Hornhautmarkierer  
 LASIK Corneal marker  
 Marcador corneal aplicación LASIK  
 LASIK marqueur pour la cornée

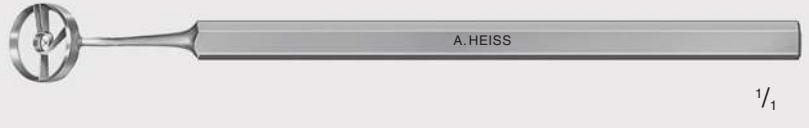

1/1

H-2648

**Dulaney**

LASIK Hornhautmarkierer  
 LASIK Corneal marker  
 Marcador corneal aplicación LASIK  
 LASIK marqueur pour la cornée



1/1

H-2600

**Maloney**

Keratometer  
 Keratometer  
 Quratometro  
 Kératoscope



1/1



1/1

H-2614

**Fechtner**

Trabekular Marker  
 Trabecutectomy marker  
 Marcador por la trabeculectomia  
 Marqueur pour la trabéculectomie



**H-2602**    **Henderson**  
 Hornhautmarkierer, zur Achsmarkierung  
 Corneal marker, to mark the axis  
 Marcador para la córnea  
 Marquer pour la cornée

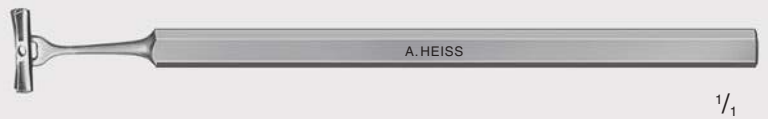

1/1



1/1

**H-2603**    **Henderson**  
 Meßring, konisch, mit Einkerbungen zur Ausrichtung an den Orientierungspunkten  
 Degree gauge, beveled, with 4 notches to adjust at the alignment marks  
 Anillo de Medición  
 Marqueur par degré

**H-2604**    **Henderson**  
 Achsenmarkierer, zur Markierung der Orientierungspunkte  
 Alignment marker, to mark the patient at the slit lamp  
 Marcador para el alineamiento  
 Marqueur pour alignement



1/1

**H-2608A**    Referenzmarkierer für Torische Linsen, 3 Klingen  
 Reference marker for toric lenses, 3 blades  
 Marcador para referencia, 3 hojas  
 Marqueur pour référence, 3 lames



1/1

**H-2608B**    Referenzmarkierer für Torische Linsen, 2 Klingen  
 Reference marker for toric lenses, 2 blades  
 Marcador para referencia, 2 hojas  
 Marqueur pour référence, 2 lames



1/1

**H-2609**    Drehbarer Hornhautmarkierer für Torische Linsen  
 Rotatable corneal marker for toric lenses  
 Marcador rotatable para la córnea, para lentes tóricos  
 Marqueur pour la cornée, rotatif, pour lentilles toriques

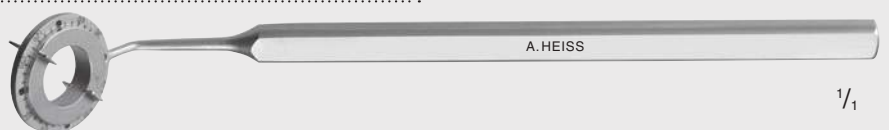

1/1



1/1

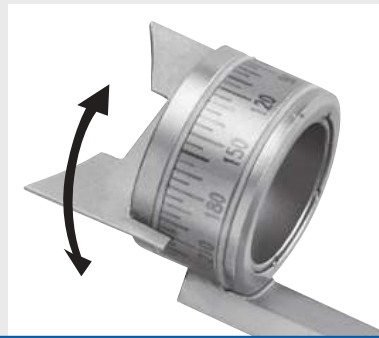

Der einstellbare Pendelmarkierer wurde speziell zur Achsmarkierung der Hornhaut bei Operationen zur Korrektur einer Hornhautverkrümmung (Astigmatismus) entwickelt. Zur Implantation torischer Hinterkammer IOL, phaker torischer IOL, LASIK, usw. kann mit dem Pendelmarkierer die Zylinderachse der Hornhaut präoperativ exakt markiert werden.

**Optimale Ergebnisse –  
 leichte Handhabung**

Durch die präzise Ausrichtung der Eingriffsachse wird eine exakte rotatorische Positionierung der IOL im Auge möglich. Überdecken die Markierungen auf der Kornea exakt die Linien auf der implantierten IOL Optik, ist ein optimales refraktives Resultat des operativen Eingriffs erreicht.

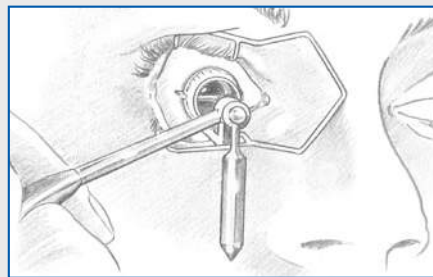

Zur Präoperativen Markierung der Zylinder- bzw. der Eingriffsachse fixiert der aufrecht sitzende Patient einen Punkt in der Ferne. Zur Markierung der Achse den Stempel zentriert auf die Kornea aufsetzen. Durch den Pendel bleibt der voreingestellte Gradzahl des Stempels während der gesamten Anwendung erhalten.

The adjustable pendulum marker was especially developed for marking axes on the cornea during surgical procedures to correct astigmatism, such as: The implantation of a toric posterior chamber IOL or a toric phakic IOL, LASIK, etc. With the pendulum marker you can preoperatively mark the cylinder axis on the cornea to ensure precise positioning of toric IOLs.

**Optimal results –  
 simple application**

When the markings on the cornea align exactly with the lines on the implanted IOL, an optimal refractive result of the surgical procedure is attained.

For the preoperative marking of the axis the patient is focusing a far point in a upright position. Place the stamp on the centre of the cornea.

The pendulum always ensures the correct degree.

**H-2660**    Einstellbarer Pendelmarkierer, 15 mm  
 Adjustable pendulum marker, 15 mm

**H-2661**    Einstellbarer Pendelmarkierer, 13 mm  
 Adjustable pendulum marker, 13 mm

**H-2670**    **Braunstein**  
 Limbusmarker 3.0 / 3.5 mm  
 Marker, 3.0 / 3.5 mm  
 Marcador, 3.0 / 3.5 mm  
 Marqueur, 3.0 / 3.5 mm

**H-2670A**    **Braunstein**  
 IVT Limbusmarker 4.0 / 3.5 mm  
 IVT Marker, 4.0 / 3.5 mm  
 Marcador IVT, 4.0 / 3.5 mm  
 Marqueur IVT, 4.0 / 3.5 mm



1/1

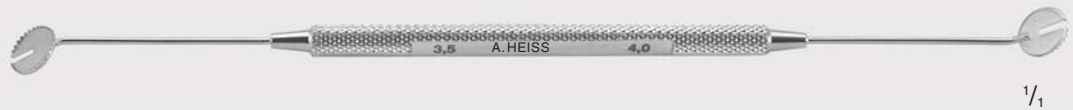

1/1

**H-2004**    IVT Doppel-Führungsinstrument, 3.5 mm / 4.0 mm, 7 mm Teller  
 IVT Marker, 3.5 mm / 4.0 mm, 7 mm plate  
 Marcador IVT, 3.5 mm / 4.0 mm, plato 7 mm  
 Marqueur IVT, 3.5 mm / 4.0 mm, plateau 7 mm



1/1

**H-2651**    Kapsulorhexismarkierer, 6.0 mm, mit 2.5 mm Ärmchen  
 Capsulorhexis marker, 6.0 mm diameter marking ring with 2.5 mm extensions  
 Marcador capsulorhexis, diámetro de 6.0 mm, con brazos de 2.5 mm  
 Marqueur capsulorhexis, diamètre de 6.0 mm, avec de

**H-2652**    Kapsulorhexismarkierer, 5.5 mm, mit 2.5 mm Ärmchen  
 Capsulorhexis marker, 5.5 mm diameter marking ring with 2.5 mm extensions  
 Marcador capsulorhexis, diámetro de 5.5 mm, con brazos de 2.5 mm  
 Marqueur capsulorhexis, diamètre de 5.5 mm, avec de

**H-2653**    **Giessen**  
 Maßstab  
 Ruler  
 Reglila  
 Règle



1/1



**H-2655 Urrets-Zavalía**

Markierer, Fixierspitze und Lokalisator  
 Marker, fixation pick and depressor  
 Marcador, punto de fijación y depresor  
 Marqueur, pique à fixation et dépresseur, permet la rotation du globe

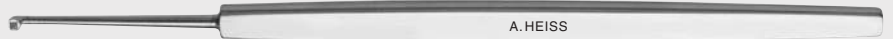

1/1

**H-2625 Vogt**

Messspatel  
 Measuring spatula  
 Reglilla  
 Spatule de mesure



1/1

**H-2650 Gonnin-Amsler**

Markierungsinstrument für die Netzhautablösung  
 Marker used in the treatment of detached retina  
 Marcador para separación de la retina  
 Marqueur, pour décollement de rétine



1/1

**Schioetz**

Tonometer Modell D  
 Tonometer model D  
 Tonómetro modelo D  
 Tonomètre, modèle D

**H-4810**

Spezifikation 5, gerade Skala,  
 im Samtetui  
 Specification 5, straight scale,  
 in velvet-lined case  
 Especificación 5, escala recta,  
 en estuche forrado de terciopelo  
 Spécification 5, échelle droit,  
 en étui velours



1/1

**H-4814**

Spezifikation 5, schrägliegende Skala,  
 im Samtetui  
 Specification 5, inclined scale,  
 in velvet-lined case  
 Especificación 5, escala inclinado,  
 en estuche forrado de terciopelo  
 Spécification 5, échelle incliné,  
 en étui velours

**H-4815**

Edelstahl, Spezifikation 5, schrägliegende Skala,  
 im Samtetui  
 Stainless steel, specification 5, inclined scale,  
 in velvet-lined case  
 Acero inoxidable, especificación 5, escala inclinado,  
 en estuche forrado de terciopelo  
 Acier inoxydable, spécification 5, échelle incliné,  
 en étui velours

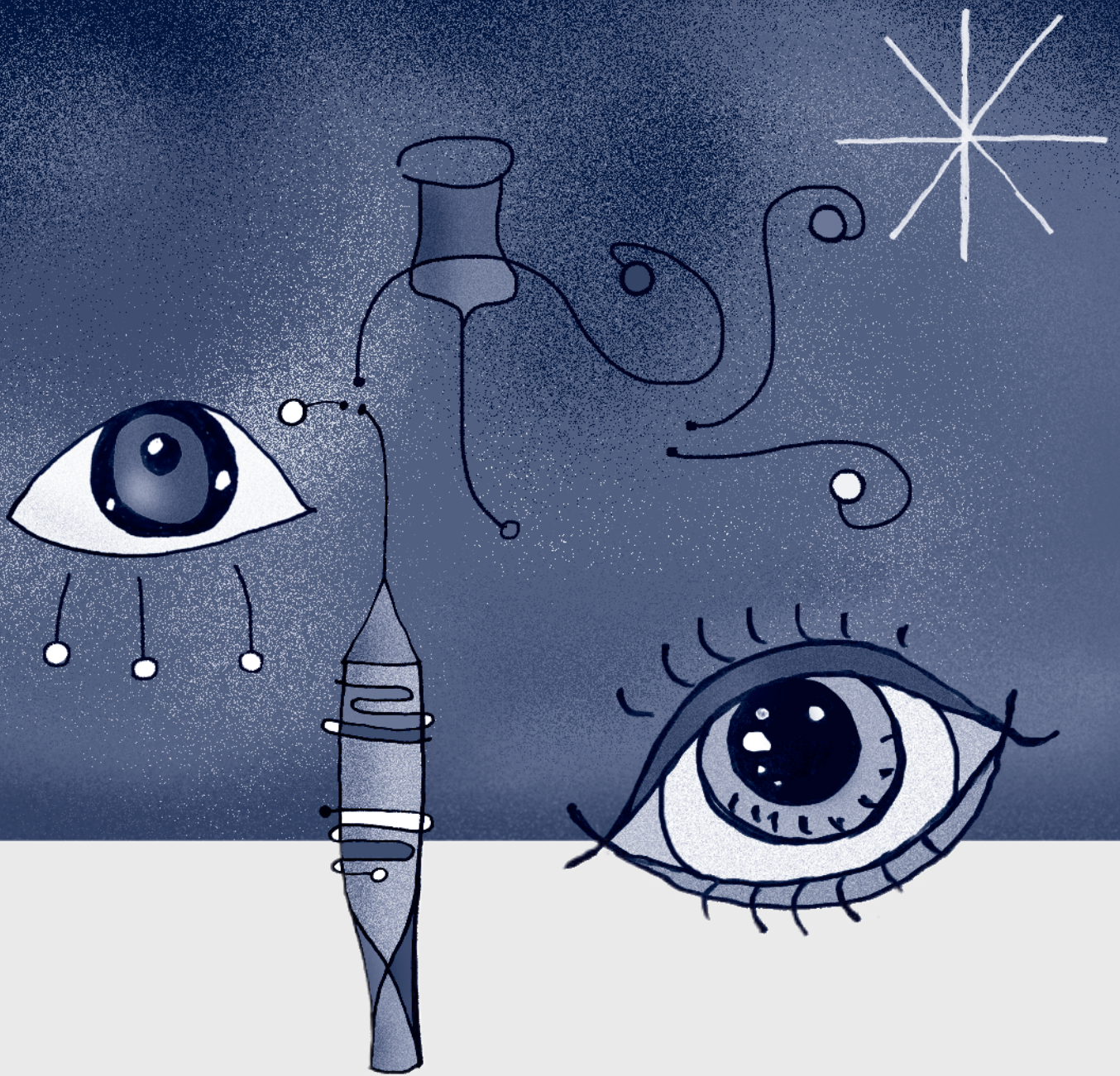

# 10

..... Kanülen  
..... Cannulas  
..... Cánulas  
..... Canules  
.....



Saughandgriff  
Aspirating handpiece  
Mango de aspiración  
Manche d'aspiration



Spitze konisch, Saugöffnung 0.3 mm  
Conical tip, aspirating port 0.3 mm  
Punta cónica y arenosa, abertura de aspiración 0.3 mm  
Pointe conique micro billée, aspiration 0.3 mm

<b>H-5700</b>	21 ga	<b>H-5701</b>	23 ga
	21 ga		23 ga
	21 ga		23 ga
	21 ga		23 ga



Spülhandgriff  
Irrigating handpiece  
Mango de irrigación  
Manche d'irrigation



Spitze konisch, Spülöffnung 2 x 0.5 mm  
Conical tip, irrigating port 2 x 0.5 mm  
Punta cónica y arenosa, abertura de irrigación 2 x 0.5 mm  
Pointe conique micro billée, irrigation 2 x 0.5 mm

<b>H-5710</b>	21 ga	<b>H-5711</b>	23 ga
	21 ga		23 ga
	21 ga		23 ga
	21 ga		23 ga



**H-5720**

**Brauweiler**

Saughandgriff, 21 ga, abgesschrägt und aufgerauht  
Aspirating handpiece, 21 ga, declined and rough  
Mango de aspiración, 21 ga, con punta achaflada y arenosa  
Manche d'aspiration, 21 ga, pointe inclinée micro billée



**H-5725**

**Koch**

Saughandgriff, 21 ga, aufgerauht  
Aspirating handpiece, 21 ga, rough  
Mango de aspiración, 21 ga, con punta arenosa  
Manche d'aspiration, 21 ga, pointe micro billée



**H-5730**

**Brauweiler**

Spülhandgriff, 21 ga  
Irrigating handpiece, 21 ga  
Mango de irrigación, 21 ga  
Manche d'irrigation, 21 ga



**H-5735**

**Brauweiler**

Spülhandgriff, mit Knöpfchen, 21 ga  
Irrigating handpiece, with bulbous tip, 21 ga  
Mango de irrigación, con botón en el cuello, 21 ga  
Manche d'irrigation col bouton, 21 ga



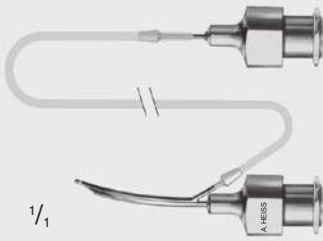

H-5390

**Simcoe**

Saug- und Spülkanüle,  
23 ga, 0,3 Aspiration  
Irrigation-Aspiration cannula,  
23 ga, 0.3 aspiration  
Cánula para irrigación  
y aspiración, 23 ga,  
0,3 aspiración  
Canule pour aspiration  
et irrigation, 23 ga,  
0,3 aspiration

H-5390A

0,4 mm Aspirationsöffnung  
0.4 mm aspiration port  
abertura de aspiración 0,4 mm  
aspiration 0,4 mm

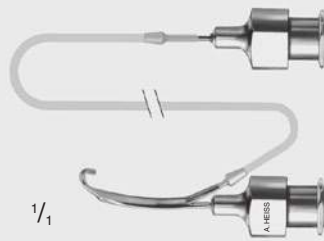

H-5393A

rechts  
right

derecha  
à droite

H-5393B

links  
left

izquierda  
à gauche

**Simcoe**

Saug- und Spülkanüle,  
23 ga 0,3 mm, Aspirations-  
öffnung gebogen  
Irrigation/aspiration cannula  
23 ga, 0.3 mm,  
aspiration port curved  
Cánula para irrigación y  
aspiración 23 ga, 0.3 mm  
abertura de aspiración curva  
Canule de irrigation/aspiration  
23 ga, aspiration 0.3 mm  
courbes

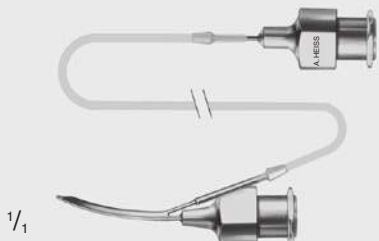

H-5391

**Simcoe**

Saug- und Spülkanüle,  
reversed, 23 ga  
Irrigation-aspiration cannula,  
reversed, 23 ga  
Cánula para irrigación  
y aspiración, reves, 23 ga  
Canule pour aspiration  
et irrigation, inversée, 23 ga



H-5130

**Brinkhorst**

Kanüle, 22 ga  
Cannula, 22 ga

gerade  
straight

recta  
droite

H-5135 rechts  
right

derecha  
à droite

H-5140 links  
left

izquierda  
à gauche



H-5141

**McIntyre-Brinkhorst**

Kanüle, 26 ga  
Cannula, 26 ga  
Cánula, 26 ga  
Canule, 26 ga

links  
left

izquierda  
à gauche

H-5142

rechts  
right

derecha  
à droite

H-5143

gerade  
straight

recta  
à droite



**H-5200** Absaugkanüle,  
1.1 mm  
Aspiration cannula,  
1.1 mm  
Cánula para aspiración,  
1.1 mm  
Canule d'aspiration,  
taille 1.1 mm



**H-5160** Spülkanüle,  
Modell Bonn  
Irrigating cannula,  
Bonn model  
Cánula para irrigación,  
modelo Bonn  
Canule irrigatoire,  
modèle Bonn,



**H-5170** Spülkanüle,  
Modell Bonn, fein  
Irrigating cannula,  
Bonn model, delicate  
Cánula para Irrigación,  
modelo Bonn, delicada  
Canule irrigatoire,  
modèle Bonn, fine



**H-5230** Sheets  
Schlingenkanüle,  
23 ga  
Irrigating vectis cannula,  
23 ga  
Lazo para irrigación,  
23 ga  
Boucle de lavage,  
23 ga



**H-5240** Knolle-Pearce  
Schlingenkanüle,  
23 ga  
Irrigating vectis cannula,  
23 ga  
Lazo para irrigación,  
23 ga  
Anse à lentilles avec irrigation,  
23 ga

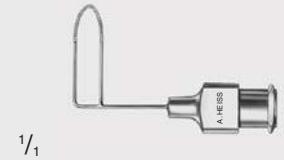

**H-5250** Simcoe  
Schlingenkanüle,  
25 ga  
Irrigating nucleus  
delivery cannula, 25 ga  
Cánula para manipulación  
del núcleo, 25 ga  
Canule pour manipulation  
du noyan, 25 ga



**H-5300** Graether  
Kragenkopfkanüle  
Cannula with collar button  
Cánula con botón en el cuello  
Canule avec bouton de faux col



**H-5310** gerade  
straight  
recta  
droite

**H-5320** abgewinkelt, rechts  
angled, right  
angulada, derecha  
coudée, à droite



**H-5570** Healon  
Injektionskanüle,  
21 ga  
Injection cannula,  
21 ga  
Cánula para inyección,  
21 ga  
Canule pour injection,  
21 ga





**H-5185** Enzymkanüle,  
24 ga  
Enzyme cannula,  
24 ga  
Cánula para enzima,  
24 ga  
Canule à enzymes,  
24 ga



**H-5270 Kratz**  
Kapselpolierer,  
sandgestrahlt, 23 ga  
Capsule polisher,  
sandblasted, 23 ga  
Pulidor para Cápsula,  
arenoso, 23 ga  
Polissoir capsulaire,  
rugueux, 23 ga



**H-5280 Kratz**  
Kapselpolierer, 23 ga,  
diamantbeschichtet  
Capsule polisher, 23 ga,  
diamond dusted  
Pulidor para cápsula, 23 ga,  
con bano de diamante  
Polissoir capsulaire, 23 ga,  
diamanté



**H-5535 Jensen**  
Kapselpolierer mit Olive,  
sandgestrahlt, 25 ga  
Capsule polisher,  
olive tip, sandblasted, 25 ga  
Pulidor para cápsula,  
punta oliva, enarenado, 25 ga  
Polissoir capsulaire, olivaire  
rugueux, 25 ga



**H-5536 Jensen**  
Kapselpolierer mit Olive,  
sandgestrahlt, 23 ga  
Capsule polisher,  
olive tip, sandblasted, 23 ga  
Pulidor para cápsula,  
punta oliva, enarenado, 23 ga  
Polissoir capsulaire, olivaire  
rugueux, 23 ga



**H-5510 Simcoe**  
Kapselpolierer,  
sandgestrahlt, 23 ga  
Capsule polisher,  
sandblasted, 23 ga  
Pulidor para cápsula,  
enarenado, 23 ga  
Polissoir capsulaire,  
rugueux, 23 ga



**H-5520 Simcoe**  
Kapselpolierer gebogen,  
sandgestrahlt, 23 ga  
Capsule polisher curved,  
sandblasted, 23 ga  
Pulidor para cápsula, curva  
enarenado, 23 ga  
Polissoir pour  
capsule postérieure,  
courbe, rugueux, 23 ga



**H-5525 Shammas**  
Kapselpolierer, 22 ga  
1 mm Becher, sandgestrahlt  
Capsule polisher, 22 ga  
1 mm Cup, sandblasted  
Pulidor para cápsula, 22 ga  
Copa 1 mm, enarenado  
Polissoir pour capsule,  
1 mm Becher, rugueux, 22 ga



**H-5530 Simcoe**  
Hinterkapselpolierer  
gebogen, mit außenliegender  
Öffnung  
Posterior capsule polisher  
curved, with reversed  
aperture  
Pulidor para cápsula  
posterior, curva,  
con apertura al revés  
Polissoir pour capsule  
postérieure, courbe,  
avec orifice à l'extérieur



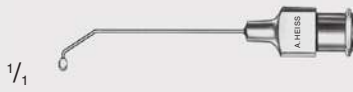

**Welsh**  
Kortex Saugkanüle, flache Olive, 25 ga  
Cortex aspirating cannula, flat olive, 25 ga  
Cánula de aspiración de corteza, oliva plana, 25 ga  
Canule d'aspiration de cortex, embout olivaire, 25 ga

- H-5146** gerade straight : recta droite  
**H-5147** links left : izquierda à gauche  
**H-5148** rechts right : derecha à droite



**H-5149 Troutman**  
Kanüle mit Olive, 25 ga  
Cannula with olive tip, 25 ga  
Cánula con punta oliva, 25 ga  
Canule embout olivaire, 25 ga



**Simcoe**  
Kortex Extraktor, 21 mm, 0.3 mm seitliche Bohrung, 23 ga  
Cortex extractor 21 mm, 0.3 mm side port, 23 ga  
Extractor para corteza 21mm, 0.3 mm apertura, 23 ga  
Extracteur de cortex, 21 mm, 0.3 mm, 23 ga

**H-5195** sandgestrahlte Spitze sandblasted tip  
punta enarenada  
bout rugueux

**H-5196** glatte Spitze smooth tip  
punta pulida  
bout lisse



**H-5540 Simcoe**  
Kortex Extraktor, gebogen, sandgestrahlt, 23 ga  
Cortex extractor, curved, sandblasted, 23 ga  
Extractor para corteza, curva, enarenado, 23 ga  
Extracteur de cortex, courbe, rugueux, 23 ga



**Anis**  
Kortex Extraktor  
Cortex extractor  
Extractor para corteza  
Extracteur de cortex

**H-5545** gerade, 23 ga straight, 23 ga  
recta, 23 ga droite, 23 ga

**H-5546** abgewinkelt, 23 ga angled, 23 ga  
angulada, 23 ga coudé, 23 ga



**H-5385 Fukasaku**  
Anästhesie-Kanüle, 24 ga  
Anesthesia cannula, 24 ga  
Cánula para anestesia, 24 ga  
Canule pour anesthésie, 24 ga



**H-5386 Stevens**  
Sub Tenon  
Anästhesie-Kanüle, 19 ga  
Sub tenon  
Anesthesia cannula, 19 ga  
Sub tenon  
Cánula para anestesia, 19 ga  
Sub tenon  
Canule pour anesthésie, 19 ga



**H-5387 Corbin**  
Sub Tenon  
Anästhesie-Kanüle, 23 ga  
Sub tenon  
Anesthesia cannula, 23 ga  
Sub tenon  
Cánula para anestesia, 23 ga  
Sub tenon  
Canule pour anesthésie, 23 ga



**H-5100 Randolph**  
Zyklodialyse Kanüle, 19 ga  
Cyclodialysis cannula, 19 ga  
Cánula para ciclodialísis, 19 ga  
Canule pour cyclodialyse, 19 ga



**H-5145** Luftkanüle, 27 ga, Modell Tübingen  
Air injection cannula, 27 ga, Tübingen model  
Cánula para Aire, 27 ga, modelo Tübingen  
Canule pour injection d'air, 27 ga, modèle Tübingen



**H-5180 Sautter**  
Luftkanüle, 27 ga  
Air injection cannula, 27 ga  
Cánula para aire, 27 ga  
Canule pour injection d'air, 27 ga



**Rycroft**  
Luftkanüle, abgewinkelt  
Air injection cannula  
Cánula para aire  
Canule à air, coudée

**H-5400** 30 ga  
**H-5410** 27 ga  
**H-5415** 25 ga



**H-5415A Rycroft**  
Luftkanüle, abgewinkelt  
Air injection cannula  
Cánula para aire  
Canule à air, coudée

horizontal abgeflacht, 25 ga  
flattened horizontal, 25 ga  
arquitrabada horizontal, 25 ga  
aplatée horizontale, 25 ga



**H-5415V Rycroft**  
Luftkanüle, abgewinkelt  
Air injection cannula  
Cánula para aire  
Canule à air, coudée

vertikal abgeflacht, 25 ga  
flattened vertical, 25 ga  
arquitrabada vertical, 25 ga  
aplatée verticale, 25 ga





**H-5000** Tränenwegkanüle,  
gerade, konisch  
Lachrymal cannula,  
straight, conical  
Cánula para canal  
lacrimal, recta, cónica  
Canule à voie lacrymal,  
droite, conique



**H-5046** Tränenwegkanüle  
gebogen, konisch, 23 ga  
Lachrymal cannula  
curved, beveled, 23 ga  
Cánula para lacrimal  
curva, cónica, 23 ga  
Canule à voie lacrymal,  
courbe, conique, 23 ga



**H-5047** Tränenwegkanüle  
gerade, konisch, 23 ga  
Lachrymal cannula  
straight, beveled, 23 ga  
Cánula para lacrimal  
recta, cónica, 23 ga  
Canule à voie lacrymal,  
droite, conique, 23 ga



**H-5010** Tränenwegkanüle,  
kniegebogen, konisch  
Lachrymal cannula,  
angled, conical  
Cánula para canal  
lacrimal, angulada, cónica  
Canule à voie lacrymal,  
coudée, conique



**H-5020** Tränenwegkanüle,  
gebogen, konisch  
Lachrymal cannula,  
curved, conical  
Cánula para canal  
lacrimal, curva, cónica  
Canule à voie lacrymal,  
courbe, conique



**H-5030** Tränenwegkanüle,  
kurz abgebogen, konisch  
Lachrymal cannula,  
short angled, conical  
Cánula para canal lacrimal,  
acodada corto, cónica  
Canule à voie lacrymal,  
coudée court, conique



**H-5040 Anel**  
Tränenwegkanüle,  
gerade, 23 ga  
Lachrymal cannula,  
straight, 23 ga  
Cánula para canal  
lacrimal, recta, 23 ga  
Canule à voie lacrymal,  
droite, 23 ga



**H-5045 Anel**  
Tränenwegkanüle,  
gebogen, 23 ga  
Lachrymal cannula,  
curved, 23 ga  
Cánula para canal lacrimal,  
curva, 23 ga  
Canule à voie lacrymal,  
courbé, 23 ga



**Bangerter**  
Tränenwegsondenkanüle,  
gerade, 21 ga  
Lachrymal Probe cannula,  
straight, 21 ga  
Cánula para canal lacrimal,  
recta, 21 ga  
Canule à voie lacrymal,  
droite, 21 ga

**H-5050** 40 mm

**H-5055** 60 mm



**H-5058**

**Jünemann**

Tränenwegsondenkanüle,  
0.8 mm, mit Griffplatte  
Lachrymal probe cannula,  
0.8 mm, with handle  
Cánula para canal lacrimal,  
0.8 mm, con mango  
Canule à voie lacrymal,  
droite, 0.8 mm, avec manche



**H-5059**

**Jünemann**

Tränenwegsondenkanüle,  
1.0 mm, mit Griffplatte  
Lachrymal probe cannula,  
1.0 mm, with handle  
Cánula para canal lacrimal,  
1.0 mm, con mango  
Canule à voie lacrymal,  
droite, 1.0 mm, avec manche



1/4



**H-5005**

Tränenwegkanüle,  
gerade, 8 mm, 23 ga  
Lachrymal cannula,  
straight, 8 mm, 23 ga  
Cánula para canal  
lacrimal, recta, 8 mm, 23 ga  
Canule à voie lacrymal,  
droite, 8 mm, 23 ga

1/4



**H-5006**

Tränenwegkanüle,  
gerade, 14 mm, 27 ga  
Lachrymal cannula,  
straight, 14 mm, 27 ga  
Cánula para canal  
lacrimal, recta, 14 mm, 27 ga  
Canule à voie lacrymal,  
droite, 14 mm, 27 ga

1/4



**H-5007**

Tränenwegkanüle,  
gebogen, 14 mm, 23 ga  
Lachrymal cannula,  
curved, 14 mm, 23 ga  
Cánula para canal  
lacrimal, curva, 14 mm, 23 ga  
Canule à voie lacrymal,  
courbe, 14 mm, 23 ga

1/4



**H-5056**

**McIntyre**

Tränenwegkanüle, gerade, 23 ga,  
0.3 mm seitliche Bohrung  
Lachrymal cannula, straight, 23 ga,  
0.3 mm side port  
Cánula para canal lacrimal, recta, 23 ga,  
con abertura de 0.3 mm  
Canule à voie lacrymal, droite, 23 ga,  
avec orifice latéral à 0.3 mm



1/4



**H-5057**

**McIntyre**

Tränenwegkanüle, gebogen, 23 ga,  
0.3 mm seitliche Bohrung  
Lachrymal cannula, curved, 23 ga,  
0.3 mm side port  
Cánula para canal lacrimal, curva, 23 ga,  
con abertura de 0.3 mm  
Canule à voie lacrymal, courbe, 23 ga,  
avec orifice latéral à 0.3 mm





**H-5060** Tränenwegkanüle, Modell Bonn  
Lachrymal cannula, Bonn model  
Cánula para canal lacrimal, modelo Bonn  
Canule à voie lacrymal, modèle Bonn



**H-5065** Cranz  
Augenbrause, Silber  
Irrigator, sterling silver  
Irrigador, de plata  
Irrigateur, argent



**H-5590** Bangerter  
Retrobulbäre Kanüle  
Retrobulbar cannula  
Cánula retrobulbar  
Canule retrobulbaire



Vitreoretinal Kanüle  
Vitreoretinal cannula  
Cánula para vitreoretinal  
Canule à vitréo-rétinienne

**H-5061** 19 ga x 32 mm  
19 ga x 32 mm  
19 ga x 32 mm  
19 ga x 32 mm

**H-5063** 23 ga x 32 mm  
23 ga x 32 mm  
23 ga x 32 mm  
23 ga x 32 mm

**H-5062** 20 ga x 32 mm  
20 ga x 32 mm  
20 ga x 32 mm  
20 ga x 32 mm

**H-5063** 25 ga x 32 mm  
25 ga x 32 mm  
25 ga x 32 mm  
25 ga x 32 mm



**H-5680** Staubsaugerhandgriff, passiv, LL Anschluss  
Backflush handpiece, passive, LL connector  
Instrumento para reflujó, conexiões LL  
Canule backflush, connecteur LL

**H-5680A** Staubsaugerhandgriff, passiv, Luer Anschluss  
Backflush handpiece, passive, Luer connector  
Instrumento para reflujó, conexiões Luer  
Canule backflush, connecteur Luer

**H-5681** Silikonreservoir allein für H-5680  
Silicone reservoir for H-5680  
Recambio de reservorio para reflujó  
Reservoir de rechange pour canule backflush



**H-5155 Charleux**  
Spül- oder Saugkanüle  
27 ga, 20 mm  
Irrigation or aspiration  
cannula, 27 ga, 20 mm  
Cánula para irrigación o  
aspiración, 27 ga, 20 mm  
Canule à irrigation ou  
aspiration, 27 ga, 20 mm



**H-5156 Charleux**  
Spül- oder Saugkanüle  
27 ga, 30 mm  
Irrigation or aspiration  
cannula, 27 ga, 30 mm  
Cánula para irrigación o  
aspiración, 27 ga, 30 mm  
Canule à irrigation ou  
aspiration, 27 ga, 30 mm



Retrobulbäre Kanüle  
Retrobulbar cannula  
Cánula retrobulbar  
Canule retrobulbaire

**H-5600** 0.6 x 40 mm

**H-5610** 0.6 x 60 mm



**H-5260 Bishop-Harmon**  
Vorderkammerspülset, 19 ga,  
Anterior chamber  
irrigator set, 19 ga  
Set de Irrigador  
para cámara anterior, 19 ga  
Set pour irrigation chambre  
antérieure, 19 ga

bestehend aus:  
consisting of:  
compuesto de:  
composé de:

**H-5261**

**H-5262**

**H-5263**

**H-5261** Silikonball  
Silicone bulb  
Balón de silicon  
Bulbe silicone

**H-5262** LL Adapter  
LL Adaptor  
LL Adaptador  
LL Adapteur

**H-5263** Vorderkammerspülkanüle,  
19 ga  
Anterior chamber irrigator,  
19 ga  
Irrigador para cámara anterior,  
19 ga  
Irrigateur pour chambre antérieure,  
19 ga

**H-5264** Vorderkammerspülkanüle,  
21 ga  
Anterior chamber irrigator,  
21 ga  
Irrigador para cámara anterior,  
21 ga  
Irrigateur pour chambre antérieure,  
21 ga





**McIntyre**

Vorderkammerkanüle, abgewinkelt  
Anterior chamber irrigator, angled  
Irrigador para cámara Anterior, angulada  
Canule pour capsule antérieure, coudée

- H-5162** 23 ga
- H-5164** 26 ga
- H-5166** 30 ga



**McIntyre**

Vorderkammerkanüle, gerade  
Anterior chamber irrigator, straight  
Irrigador para cámara Anterior, recta  
Canule pour capsule antérieure, droite

- H-5163** 23 ga
- H-5165** 26 ga
- H-5167** 30 ga



**H-5266**

**Lewicky**

Vorderkammerkanüle, 20 ga  
Anterior chamber maintainer, 20 ga  
Cánula para cámara anterior, 20 ga  
Canule pour capsule antérieure, 20 ga



**Gimbel**

LASIK Spülkanüle, 25 ga  
LASIK Fountain cannula, 25 ga  
LASIK Cánula para irrigación, 25 ga  
LASIK Canule irrigatoire, 25 ga



- H-5660** links ..... izquierda
- left ..... à gauche
- H-5661** rechts ..... derecha
- right ..... à droite



**Vidaurri**

LASIK Spülkanüle  
LASIK Irrigation cannula  
LASIK Cánula para irrigación  
LASIK Canule irrigatoire

- H-5662** vertikal ..... vertical
- vertical ..... verticale
- H-5663** horizontal ..... horizontal
- horizontal ..... horizontale



**Buratto**

LASIK Kanüle  
LASIK Cannula  
Cánula para LASIK  
LASIK Canule



- H-5255** 25 ga
- H-5256** 23 ga



**H-5664**

**Fukasaku**

LASIK Kanüle, 23 ga  
LASIK Cannula, 23 ga  
Cánula para LASIK, 23 ga  
LASIK Canule, 23 ga



**H-5257**

**Banaji**

Spülkanüle, 25 ga. 6 Spülöffnungen  
Irrigation cannula, 25 ga. 6 ports  
Cánula para irrigación, 25 ga. 6 ports  
Canule à irrigation, 25 ga. 6 ports irrigatoires



**H-5770** Saug- / Spülhandgriff  
für auswechselbare Spitzen  
Aspiration / Irrigation handle  
for interchangeable tips  
Cánula para irrigación ó aspiración  
Canule à irrigation ou aspiration



1/1

**H-5771** Saug- / Spül-Tip Metall, 2 mm, 60° abgewinkelt, 19 ga  
Aspiration-irrigation tip, metal, 2 mm, 60° angled, 19 ga  
Cánula para irrigación ó aspiración, angulada 60°, 19 ga  
Canule à irrigation ou aspiration, métal, coudée en 60°, 19 ga



1/1

**H-5772** Saug- / Spül-Tip Metall, gerade, 19 Ga.  
Aspiration-irrigation tip, metal, straight, 19 Ga.  
Cánula para irrigación ó aspiración, recta, 19 ga  
Canule à irrigation ou aspiration, métal, droite, 19 ga



1/1

**H-5773** Saug- / Spül-Tip Metall, abgewinkelt, 19 ga  
Aspiration-irrigation tip, metal, angled, 19 ga  
Cánula para irrigación ó aspiración, metal, angulada, 19 ga  
Canule à irrigation ou aspiration, métal, coudée, 19 ga



1/1

**H-5774** Saug- / Spül-Tip Silikon, gerade, 19 ga  
Aspiration-irrigation tip, silicone, straight, 19 ga  
Cánula para irrigación ó aspiración, silicona, recta, 19 ga  
Canule à irrigation ou aspiration, silicone, droite, 19 ga



1/1

**H-5775** Saug- / Spül-Tip Silikon, abgewinkelt, 19 ga  
Aspiration-irrigation tip, silicone, angled, 19 ga  
Cánula para irrigación ó aspiración, silicona, angulada, 19 ga  
Canule à irrigation ou aspiration, silicone, coudée, 19 ga



1/1



**H-5776** Saug- / Spül-Tip Metall, Modell Brinkhorst, 19 ga  
Aspiration-irrigation tip metal, Brinkhorst model, 19 ga  
Cánula para irrigación ó aspiración, metal, modelo Brinkhorst, 19 ga  
Canule à irrigation ou aspiration, métal, modèle Brinkhorst, 19 ga



**H-5777** Saug- / Spül-Tip Silikon, gerade 20 ga  
Aspiration-irrigation tip silicone, straight 20 ga  
Cánula para irrigación ó aspiración, silicona, recta, 20 ga  
Canule à irrigation ou aspiration, silicone, droite, 20 ga



**H-5778** Saug- / Spül-Tip Silikon abgewinkelt, 20 ga  
Aspiration-irrigation tip silicone, angled, 20 ga  
Cánula para irrigación ó aspiración, silicona, angulada, 20 ga  
Canule à irrigation ou aspiration, silicone, coudée, 20 ga



**H-5779** Saug- / Spül-Tip Silikon, gerade 22 ga  
Aspiration-irrigation tip silicone, straight 22 ga  
Cánula para irrigación ó aspiración, silicona, recta, 22 ga  
Canule à irrigation ou aspiration, silicone, droite, 22 ga



**H-5780** Saug- / Spül-Tip Silikon abgewinkelt, 22 ga  
Aspiration-irrigation tip silicone, angled, 22 ga  
Cánula para irrigación ó aspiración, silicona, angulada, 22 ga  
Canule à irrigation ou aspiration, silicone, coudée, 22 ga

**H-5640 McIntyre**

Spülhandgriff, Kunststoff,  
autoklavierbar, männliche Anschlüsse

Infusion handle, plastic,  
autoclavable, male connectors

Mango para irrigación, de plástico,  
autoclavable, conexiones Luer

Manche irrigation, plastique,  
autoclavable, m-connecteur

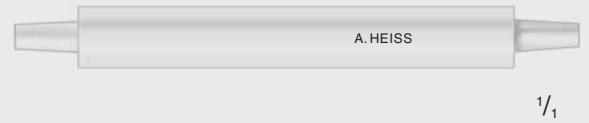

1/1

**H-5640A McIntyre**

Spülhandgriff, Kunststoff,  
autoklavierbar, m-w Anschlüsse

Infusion handle, plastic,  
autoclavable, m-f connectors

Mango para irrigación, de plástico,  
autoclavable, conexiones m-f

Manche irrigation, plastique,  
autoclavable, m-f connecteur

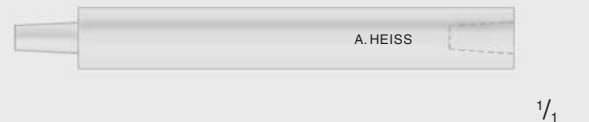

1/1

**H-5650** Spülhandgriff  
m-m Anschlüsse

Infusion handle,  
m-m connectors

Mango para irrigación,  
conexiones m-m

Manche irrigation,  
m-m connecteur



1/1

**H-5655** Spülhandgriff  
m-w Anschlüsse

Infusion handle,  
m-f connectors

Mango para irrigación,  
conexiones m-f

Manche irrigation,  
m-f connecteur



1/1

**H-5656** Spülkanülenhandgriff männlich / Schlauch- Anschlüsse, 11.5 cm lang

Infusion handle, male / tube connectors, 11.5 cm

Mango para irrigación, conexiones: macho / manguera, 11.5 cm

Manche irrigation, connecteur: mâle / tuyau, 11.5 cm



1/1

**H-5657** Spülkanülenhandgriff männlich / Schlauch- Anschlüsse, 7.5 cm lang

Infusion handle, male / tube connectors, 7.5 cm

Mango para irrigación, conexiones: macho / manguera, 7.5 cm

Manche irrigation, connecteur: mâle / tuyau, 7.5 cm



1/1







# 11

- Steriliserbehälter
- Sterilizing Cases
- Cajas para Esterilización
- Boîtes de stérilisation



Sterilisieretui, Kunststoff, mit Silikonbänkchen für 1 Instrument  
 Sterilisation tray, plastic, with two silicone bars for one instrument  
 Caja para esterilización, plástico, con soporte de silicona para un instrumento  
 Boîte de stérilisation, plastique, avec supports silicone pour 1 instrument

**H-7050**

Innenmaße L × B × H  
 Inner dimensions L × W × H  
 Dimensión interior L × A × A  
 Dimensions intérieures L × l × H  
 152 × 64 × 19 mm



Sterilisieretui, Kunststoff, mit Silikonmatte  
 Sterilisation tray, plastic  
 Caja para esterilización, plástico, con alfombra de silicona  
 Boîte de stérilisation, plastique, avec tapis en silicone

**H-7060**

Innenmaße L × B × H  
 Inner dimensions L × W × H  
 Dimensión interior L × A × A  
 Dimensions intérieures L × l × H  
 152 × 64 × 19 mm



**H-7061**

Innenmaße L × B × H  
 Inner dimensions L × W × H  
 Dimensión interior L × A × A  
 Dimensions intérieures L × l × H  
 190 × 64 × 19 mm



**H-7062**

Innenmaße L × B × H  
 Inner dimensions L × W × H  
 Dimensión interior L × A × A  
 Dimensions intérieures L × l × H  
 162 × 102 × 19 mm

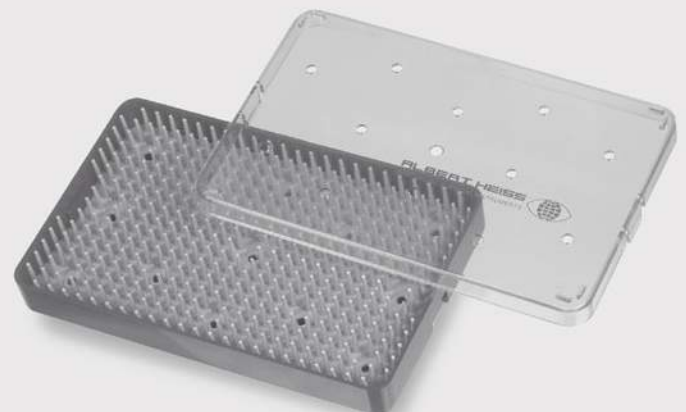

Sterilisieretui, Kunststoff, mit Silikonmatte  
Sterilisation tray, plastic  
Caja para esterilización, plástico, con alfombra de silicona  
Boîte de stérilisation, plastique, avec tapis en silicone

**H-7063**

Innenmaße L × B × H  
Inner dimensions L × W × H  
Dimensión interior L × A × A  
Dimensions intérieures L × l × H  
254 × 152 × 19 mm



**H-7064**

Innenmaße L × B × H  
Inner dimensions L × W × H  
Dimensión interior L × A × A  
Dimensions intérieures L × l × H  
254 × 152 × 38 mm

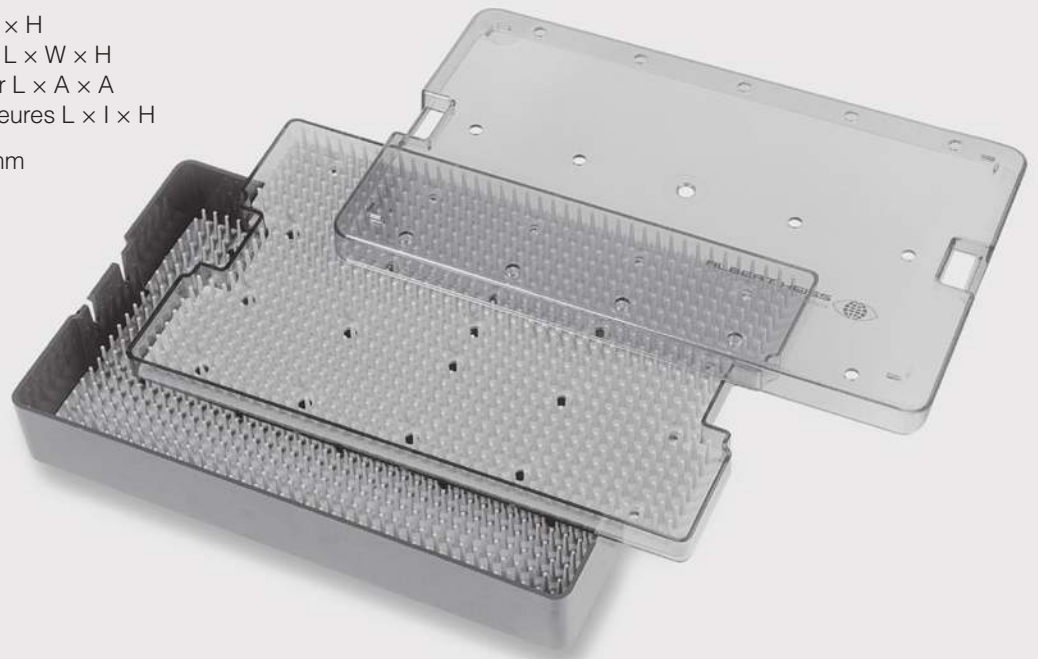

## lubriPEN



### H-7123 lubriPEN

Ölstift, 12 ml Füllmenge  
Synthetisches Pflegeöl aus deutscher Herstellung  
zur Pflege und Wartung von wiederverwendbaren  
chirurgischen Instrumenten.

Oil pen, 12 ml, 0.4 fl. oz  
Synthetical care oil of german fabrication for the  
care and maintenance of reusable surgical instruments.

**Characteristics:**

Vapour permeable and thermally stable until 260 °C / 500 °F  
Odourless, transparent and free of silicone  
No spots or crust formation on the instrument surface  
Prevention from friction corrosion  
Exact dosage by using the stainless steel tip  
Anti-slip handle



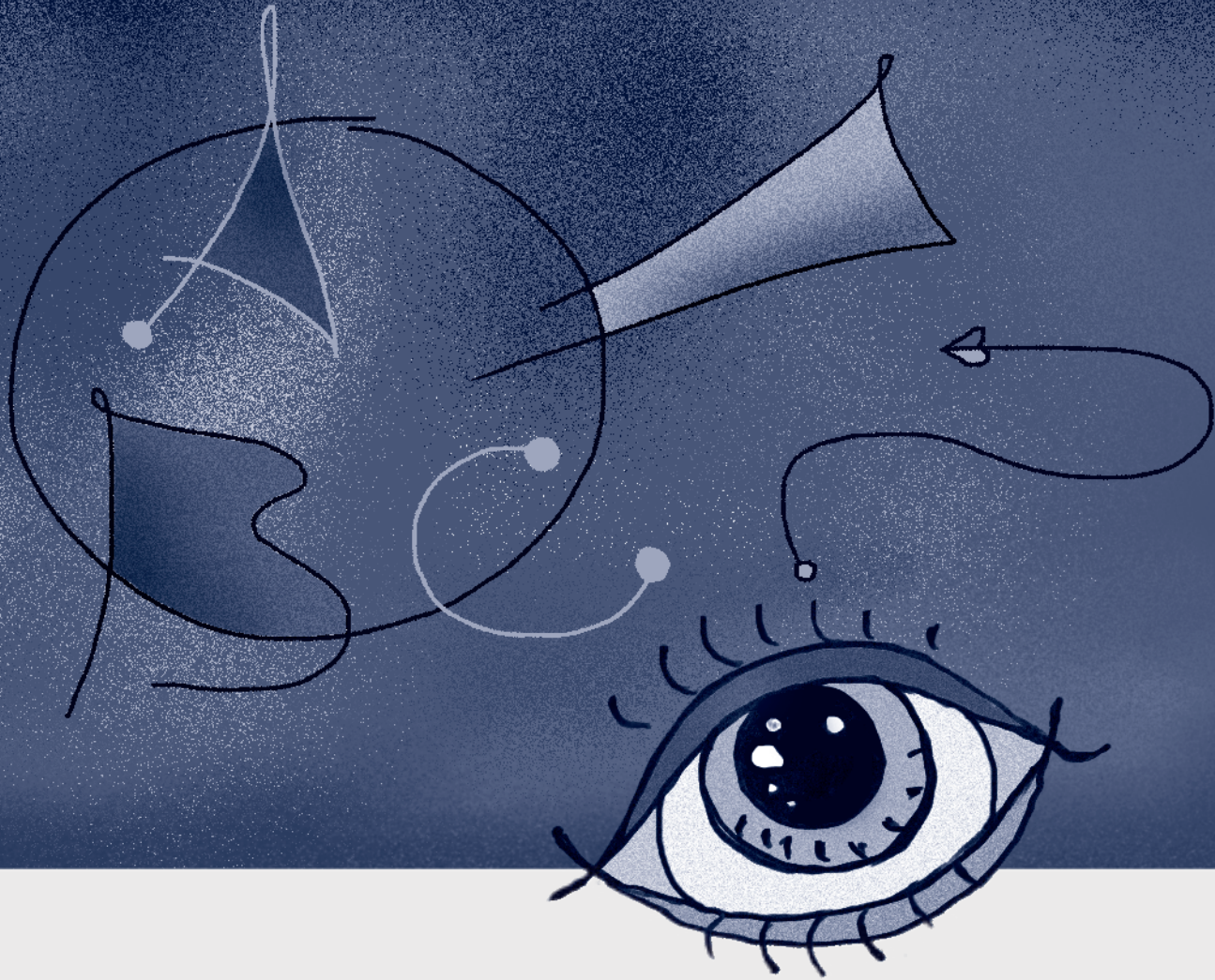

# 12

- ⋮ Sachwortregister, alphabetisch
- ⋮ Index, alphabetical
- ⋮ Índice alfabético
- ⋮ Index alphabétique
- ⋮

## Deutsch

Deutsch	Seite	Deutsch	Seite	Deutsch	Seite
<b>A</b> Absaugkanüle	199	Beehler Pupillendilatator	26, 27	Chayet LASIK Hornhautmanipulator	192
Adapter	210	Beer Cilienpinzette	121	Chirurgische Pinzette	92, 93
Adson Anatomische Pinzette	93	Berke Muskelpinzette	128	Chu Lidsperrerr mit Aspiration	19
Adson Chirurgische Pinzette	93	Beyer Knochenstanze	181	Cilienpinzette	121
Agricola Wundspreizer	23	Bindehaut Dissektor	77	Citelli Knochenstanze	181
Akahoshi Pre-Chopper	97	Bindehautpinzette	119, 120	Clark Lidsperrerr	8
Alfonso Lidsperrerr	13	Bishop-Harmon Irispinzette	85, 86	Clayman Linsenimplantationspinzette	103
Allzweckpinzette	92, 94	Bishop-Harmon Vorderkammer-Spülkanüle	207	Clayman Linsenkernelrotator	65
Anästhesie Kanüle	202	Bishop-Harmon Vorderkammer-Spülset	207	Cook Lidsperrerr	20
Anatomische Pinzette	92, 93	Blaydes Linsenimplantationspinzette	103	Corbett Fremdkörpernadel	51
Anel Tränenwegkanüle	204	Blumental Bindehautdissector	77	Corbin Sub Tenon Anästhesie Kanüle	202
Anis Hornhautmarkierer	191	Bonaccolto Allzweckpinzette	94	Corcelle Lidsperrerr	8
Anis Kortex Extraktor	202	Bonn Iris Scissors	148	Corneaskleralstanze	185
Anis Linsenkernelmanipulator	65	Bonn Irispinzette	84, 90, 91	Corydon Kapsulorhexispinzette	99, 101
Anis Nahtmarkierer	191	Bonn Mikro-Irishäkchen	60	Cranz Augenbrause	206
Arlt Drahtschlinge	83	Bores Hornhautfixierpinzette	119	Crawford Intubationsset	179
Arruga Kapselpinzette	94	Bores Hornhautmarkierer	190, 191	Crozafof MICCS Kapsularhexis Pinzette	98
Arruga Nadelhalter	174	Bowman Augensonde	179	Culler Irisspatel	61
Arterienklemme	130	Bowman Diszissionsnadel	50	Culler Muskelhaken	29
Aubaret Tränensackhäkchen	27	Bracken Irispinzette	88		
Aufnahme- und Faltpinzette	104	Braunstein Limbusmarker	189	<b>D</b> Dardenne Fragmentpinzette	105
Augenbrause	206	Brauweiler Saughandgriff	198	Dastoor Bindehautpinzette	119
Augenschere	149	Brinkhorst Kanüle	199	Dastoor Muskelpinzette	128
Augenskalpell	46	Bucher-Kansas Kernspalter	75	Dastoor Nahtpinzette	112, 116
Augensonde	179	Bunge Exenterationslöffel	54	Daviel Starlöffel	54
Axenfeld Chalazions-Doppellöffel	53	Buratto LASIK Flappinzette	120	Descemet Spatel	79
Axenfeld Haken	27	Buratto LASIK Flapprotector	81	Descemet Membranstanze	185
Axenfeld Wundspreizer	22	Buratto LASIK Kanüle	208	Desmarres Chalazionspinzette	124
Ayer Chalazionspinzette	124	Buratto Linsenpinzette	105	Desmarres Lidhalter	24
				Diamantmesser	36 – 45
<b>B</b> Backhaus Tuchklemme	130	<b>C</b> Camellin LASEK Alkoholtrichter	80	Dieffenbach Gefäßklemme	130
BAIRD Chalazionspinzette	125	Carter Halte- und Impantationspinzette	184	Dilatator	180
Bandspreizpinzette	121	Castroviejo Dilator	180	Diszissionsmesser	47, 48
Bangerter Lidsperrerr	22	Castroviejo Doppelspatel	78	Diszissionsnadel	50
Bangerter Muskelpinzette	128	Castroviejo Fadenpinzette	107	Dodick Nukleusspalter	73, 76
Bangerter Retrobulbäre Kanüle	206	Castroviejo Fixierpinzette	127	Dodick Nukleusteiler	96
Bangerter Spatel	60, 82	Castroviejo Hornhautschere	140, 142, 144	Dodick-Kammann Kernspalter	73
Bangerter Tränenwegsondenkanüle	204	Castroviejo Hornhauttrephine	55	Doppelevator	184
Barkan Goniotomiemesser	48	Castroviejo Irisschere	132	Doppelhäkchen	26
Barraquer Cilienpinzette	121	Castroviejo Kapselpinzette	94	Doppelspatel	78
Barraquer Fadenlöspinzette	106	Castroviejo Lidsperrerr	22	Drahtschlinge	83
Barraquer Fadenpinzette	106	Castroviejo Mikro-Nadelhalter	160, 167 – 169	Druckplatte	146
Barraquer Hornhautschere	140	Castroviejo Mikro-Schere	145	Drysdale Linsenkernelmanipulator	66
Barraquer Iridektomieschere	132	Castroviejo Nadelhalter	175	DSAEK Descemet Spatel	79
Barraquer Irisspatel	61	Castroviejo Nahtpinzette	113 – 115, 117	DSAEK Implantationsspatel	79
Barraquer Keratoplastikmesser	55	Castroviejo Schere	144	DSAEK Pinzette	120
Barraquer Klingshalter	166	Castroviejo Zirkel	188	Dulaney LASIK Hornhautmarkierer	192
Barraquer Lidsperrerr	12, 13, 15	Castroviejo Zyklodialysespatel	82		
Barraquer Mikro-Nadelhalter	170 – 173	Catalano Tränenweg Intubations-Set	179	<b>E</b> Elevatorium	184
Barraquer Mikro-Nahtpinzette	112	Cauer Chalazionspinzette	124	Elschnig Fixierpinzette	126
Barraquer Nahtpinzette	108	Chalazions-Doppellöffel	53	Entropionpinzette	128
Barraquer-Oosterhuis Lidsperrerr	11	Chalazionslöffel	52, 53	Enukleationsschere	152
Barraquer-Oosterhuis-Kratz Lidsperrerr	11	Chalazionsmesser	46	Enzymkanüle	201
Barraquer-Troutman Mikro-Nadelhalter	167	Chalazionspinzette	124, 125	Erhardt Lidpinzette	125
Barrett Lidsperrerr	8	Chang-Liebermann Mikro-Finger	76	Ernest Nukleusteiler	96
Beaupré Cilienpinzette	121	Charleux Spül- & Saugkanüle	207	Exenterationslöffel	54, 81



## Deutsch

Deutsch	Seite	Deutsch	Seite	Deutsch	Seite
<b>F</b> Fadenlöspinzette	106	Graefe Schielhaken	28	Injektionskanüle	200
Fadenpinzette	106 – 111, 156, 157	Graefe Skarifikateur	47	Inzisions-Messzirkel	189
Faltpinzette	104	Graefe Starlöffel	54	IOL Implantationspinzette	103
Fasspinzette für Skleranägel	95	Graefe Starmesser	47	IOL Manipulator	66, 154
Fasziennadel	180	Graether Irisretraktor	60	Iridektomieschere	132
Faulkner Linsenpinzette	105	Graether Kragenkopf-Kanüle	200	Irishäkchen	60, 67, 155
Fechtner Bindehautpinzette	120	Green Fixierpinzette	126	Irispinzette	86 – 91, 160
Filter	215	Green Schielhaken	29	Irisrepositor	62
Fine-Thornton Fixierring	32	Gross Sub Tenon Anästhesie Kanüle	203	Irisretraktor	60
Fink Muskelhaken	26	Guimaraes LASIK Spatel	79	Irisschere	132, 146
Fixierpinzette	125, 126	Guthrie Doppelhäkchen	26	Irisspatel	60 - 62
Fixierring	32 – 34				
Flachmeißel	182	<b>H</b> Haberle-McPherson		<b>J</b> Jaeger Lidplatte	26
Flieringa Fixierring	32	Linsenhaltepinzette	105	Jaeger Schielhaken	29
Fragmentpinzette	104, 105, 158	Haeflinger Kernspalter	74	Jaffe Fadenpinzette	109
Francis Chalazionspinzette	125	Häkchen	27 – 30, 63, 64, 79	Jaffe Kapsulorhexis Pinzette	97, 162
Francis Fremdkörperinstrument	51	Halsted-Mosquito Arterienklemme	130	Jaffe Lidhalter	24
Frankel Lidsperrer	17	Halte- und Implantationspinzette	184	Jaffe Linsenspatel	69
Freer Doppelevator	184	Hammer	182	Jaffe-Bechert Linsenkernrotator	65
Freer Flachmeißel	182	Harms Trabekular-Sonde	178	Jameson Messinstrument	189
Fremdkörperinstrument	50 – 52	Harris-Sinsky Linsen Häkchen	64	Jameson Schielhaken	28
Fremdkörperlöffel	50, 52	Hartman Arterienklemme	130	Jameson Vorlagerungspinzette	129
Fremdkörperradel	50 – 52	Hartmann-Halle Nasenspekulum	183	Jayle Nahtpinzette	112
Fremdkörperpinzette	123	Healon Injektionskanüle	200	Jensen Kapselpolierer	201
Fremdkörperschlinge	184	Hebra Chalazionslöffel	52	Johnson-Tookey Hornhautmesser	49
Frenzl Linsenmanipulationshäkchen	67	Heiss Wundspreizer	23	Jones Tuchklemme	130
Friedmann Hohlmeißelzange	183	Helveston Fadenpinzette	110	Jünemann Tränenwegsondenkanüle	205
Fukasaku Anästhesie Kanüle	202	Helveston Retraktor	25	Juweliers-Typ Fadenpinzette	110, 111
Fukasaku LASIK Kanüle	208	Helveston Schielhaken	29, 30		
Fukasaku LASIK Spatel	81	Henderson Achsenmarkierer	193	<b>K</b> Kalt Nadelhalter	174
Fukasaku Nukleusspalter	77	Henderson Hornhautmarkierer	193	Kansas Kernspalter	75
		Henderson Meßring	193	Kansas Linsenkernpinzette	105
<b>G</b> Gaskin Fragmentpinzette	104, 105, 158	Henry Cilienpinzette	121	Kanüle	199 – 208
Gass Corneaskleralstanze	185	Hess Irispinzette	89	Kapselfragment Pinzette	100 – 101
Gass Häkchen	28	Hinterkapselpolierer	201	Kapselpinzette	94 – 96
Gass Sklera Marker	25	Hirschman Linsenspatel	69	Kapselpinzette Schweizer Modell	94
Gefäßklemme	130	Hoffer Hornhautmarkierer	190	Kapselpolierer	201
Gianetti MICS Kapsulorhexis Pinzette	98	Hoffer-McPherson Nahtpinzette	117	Kapselschere	134
Gießen Dilator	181	Hofmann-Thornton Fixierring	32	Kapselstanze	184
Gill Hornhautmesser	49	Hohlmeißel	50	Kapsulorhexis Pinzette	97 – 101, 161 – 163
Gill Irispinzette	89	Hohlmeißelzange	183	Katzen LASIK Hornhautspatel	81
Gill-Botvin Irispinzette	89	Holth Kapselstanze	184	Katzin Mikro-Hornhautschere	143
Gill-Hess Irispinzette	89	Hornhaut Nahtpinzette	113	Keener Schlingeninstrument	75
Gill-Hess Mikro-Irispinzette	89	Hornhautdissektor	49	Kellnar Trabekular-Sonde	178
Gimbel LASIK Kanüle	208	Hornhaut-Flap-Spatel u. Repositionsspatel	77	Kelly Descements Membranstanze	185
Gimpel LASIK Fixationsring	32	Hornhautmarkierer	190 – 193	Kelman-McPherson Nahtpinzette	116, 117, 157, 159
Girard Synechienspatel	78	Hornhautmesser	48, 49		
Glaucomstanze	185	Hornhautpinzette	117 – 119, 158	Kennzeichnungsschild	215
Glaukom Pinzette	95	Hornhautschaber	49	Keratometer	192
Goldstein Wundspreizer	23	Hornhautschere	140 – 146	Keratoplastikmesser	55
Golf Club Fremdkörperradel	51	Hornhauttrephine	55, 56	Keratoplastikspatel	82
Goniotomiemesser	48	Hunt Chalazionspinzette	124	Kernspalter	71 – 77, 155
Gonnin-Amsler Markierungsinstrument	196	Hydrodissektionskanüle	203	Kerrison Knochenstanze	181
Gradle Cilienpinzette	121			Kershner Lidsperrer	16
Graefe Fixierpinzette	125	<b>I</b> Implantationspinzette	103	Kimura Spatel	77
Graefe Irishäkchen	60	Inamura Kapsulorhexis Pinzette	98		



## Deutsch

Deutsch	Seite	Deutsch	Seite	Deutsch	Seite
Kirby Drahtschlinge	68, 83	Linsenimplantationspinzette	103	Mikro-Fixierpinzette	118, 161
Kirby Fixierpinzette	127	Linsenkernmanipulator	66, 67, 154	Mikro-Glaukomstanze	185
Kirby Linsenlöffel	54	Linsenkernrotierer	64, 65, 154	Mikro-Hornhautpinzette	118
Kirby Linsenschieber	68	Linsenmanipulationshäckchen	66, 67	Mikro-Hornhautschere	141 – 143
Klingenhalter	166	Linsenmanipulator	66, 67	Mikro-Irishäkchen	60
Knochenstanze	181	Linsenpinzette	105, 106	Mikro-Irispinzette	90, 91, 160
Knolle Linsenspatel	69	Linsenschieber	68	Mikro-Keratome-Schere	141
Knolle-Pearce Schlingenkanüle	200	Linsenspatel	68, 69	Mikro-Klingenhalter	166
Knorz Lidsperrerr	19	Livernois Aufnahme- und Faltpinzette	104	Mikro-Nachstarschere	133 – 138
Koch Linsenspatel	70	Livernois Linsenpinzette	106	Mikro-Nadelhalter	167 – 175, 163
Koch Manipulator	74	Lokalisator	25	Mikro-Nahtpinzette	112 – 119, 158 – 160
Koch Saughandgriff	198	Lordan Chalazionspinzette	124	Mikro-Schere	133 – 137, 141
Kortex-Extraktor	202	Lu Chayet LASIK Hornhautmarkierer	192	Moehle Hornhautpinzette	117
Kraff Kapselpinzette	96	Lu LASIK Hornhautmarkierer	192	Moody Fixierpinzette	126
Kragenkopf-Kanüle	200	Luftkanüle	203	Moorfield Naht- und Bindehautpinzette	119
Kratz Kapselpolierer	201	Lu-Mendez Mess- & Fixiering	32	Mueller Wundspreizer	23
Kratz Lidsperrerr	13	Luntz-Dodik Glaukomstanze	185	Murdock Lidsperrerr	20
Kratz-Barraquer Lidsperrerr	10, 11			Muskelhaken	26, 29, 30
Kreissig Lokalisator	25	<b>M</b> Mackensen Trabekular-Sonde	178	Muskelklemme	127
Kuglen Irishäkchen	67	Maddox LASIK Spatel	81	Muskelpinzette	127, 128
Kuhnt Hornhautschaber	49	Magnet	184	<b>N</b> Nadelhalter	165 – 175, 163
		Maloney IOL Manipulator	66	Nagahara Kernspalter	74
<b>L</b> La Force Fremdkörperinstrument	51	Maloney Keratometer	192	Nahtmarkierer	191
Lagrange Sklerektomieschere	152	Manis Buratto LASIK Flapprotector	81	Nahtpinzette	112 – 117, 158 – 160
Lambert Chalazionspinzette	124	Markierungsinstrument	189 – 195	Nahtpinzette, Mod. Zürich	116
Lancaster Lidsperrerr	8	Masket Kapsulorhexis Pinzette	100, 162	Nasenspekulum	183
Laqua Lokalisator	25	Maßstab	185	Neuhann Kernspalter	71, 72
LASEK Alkoholtrichter	80	Mawas Irisretraktor	60	Neuhann Kernspalter und Manipulator	71
LASEK Epitheldissektor	80	McCullough anatomische Pinzette	92	Neuhann Spatel & Kernspalter	71
LASEK Epithelrechen	80	McCullough Nahtpinzette	92	New Orleans Drahtschlinge	83
LASEK Epithelspatel	80	McDonald Faltpinzette	104	Noyes Iridektomieschere	133
LASEK Flap Repositionsspatel	80	McInryre Drahtlidsperrerr	13	Nugent Allzweckpinzette	94
LASEK Spatel	80	McIntire Tränenwegkanüle	205	Nukleusspalter	76, 77
LASEK Trepan	80	McIntyre Spülhandgriff	211	Nukleusteiler	96
LASIK Flappinzette	120	McIntyre Vorderkammer-Kanüle	208		
LASIK Flapprotector	81	McIntyre-Brinkhorst Kanüle	200	<b>O</b> Obstbaum Linsenspatel	69
LASIK Hornhautmarkierer	192, 194	McPherson Fadenpinzette	103, 105, 158	Ong Kapselschere	1324
LASIK Spatel	81	McPherson Hornhautpinzette	117, 119	Orbitalspatel	31
LASIK Kanüle	208	McPherson Nadelhalter	172	Osher Inzisions-Messzirkel	189
Lehner Kapsulorhexis Pinzette	97, 163	McPherson Nahtpinzette	113, 115, 158	Osher Irispinzette	89
Lester Fixierpinzette	126	McPherson-Westcott Sehensschere	139	Osniaka-Faulkner Linsenpinzette	105
Lester IOL Manipulator	66, 154	Mead Hammer	182		
Lester-Burch Lidsperrerr	8	Meißel	182	<b>P</b> Panas Fixierpinzette	125
Levinson Fremdkörpernadel	50	Mellinger Lidsperrerr	9	Park Lidsperrerr	21
Lewicky Linsenhäkchen	64	Membranstanze	185	Park-Guyton Lidsperrerr	21
Lewicky Vorderkammerkanüle	208	Mendez LASIK Hornhautmarkierer	192	Park-Maumenee Lidsperrerr	21
Lidhalter	25 – 26	Mendez Messring	191	Paton Hornhautdissektor	49
Lidpinzette	125	Mermoud Glaukom Pinzette	95	Paton Keratoplastikspatel	82
Lidplatte	26	Mess- & Fixiering	32	Paton Nadelhalter	174
Lidsperrerr	8 – 22	Messring	191	Paufique Fadenpinzette	108
Liebermann Lidsperrerr	14 – 18	Messspatel	196	Paufique Keratoplastikmesser	55
Liebermann Mikro-Finger	74	Meyhoefer Chalazionslöffel	53	Paufique Nahtpinzette	115
Ligaturschere	152	MICS Kapsulorhexis Pinzette	96	Paul Wundhaken	28
Limbusmarker	189, 195	Mikro-Fadenpinzette		Pendelmarkierer	194
Linsen-Faltpinzette	104		116, 106 – 110, 157 – 161, 118		
Linsenhäkchen	63, 64, 154	Mikro-Finger Nukleus Manipulator	74		

## Deutsch

Deutsch	Seite	Deutsch	Seite	Deutsch	Seite
Phako Spatel	62	Simcoe Schlingenkanüle	200	Troutman-Barraquer Mikro-Nadelhalter	173
Pierse Mikro-Fixierpinzette	118, 161	Simpson Dilatator	177	Tübingen Modell, Luftkanüle	203
Pierse-Colibri Hornhautpinzette	118	Sinsky Linsenhäkchen	63, 64, 154	Tübingen Modell, Schere	135
Pigtail-Sonde	180	Skalpelloff Nr. 3	57	Tuchklemme	130
Pinzette	86 – 129, 156 – 162	Skalpelloff Nr. 7	57	<b>U</b> Urrrets-Zavalía Markierer	196
Pisacano Linsenkerntrotierer	65	Skalpelloff, Mikro Skalpelloffklängen	57	Uthoff Kapselschere	134
Plange Fremdkörpernadel	51	Skarifikateur	47	Uthoff Repositionshäkchen	63
Pley Lidsperrerr	16	Sklera Marker	25	Utrata Kapsulorhexis Pinzette 97, 101, 161, 162	
Polack Hornhaut Nahtpinzette	113	Sklerektomieschere	152		
Pre-Chopper	97	Sloane LASEK Spatel	80	<b>V</b> Vannas Mikro-Nachstarschere 133 – 135	
Pterygiummesser	47	Snellen Drahtschlinge	83	Vidaurri LASIK Kanüle	208
Putterman Klemme	129	Snellen Entropionpinzette	128	Vitrektomie Schere	146, 147
<b>R</b> Randolph Zyklodialysekanüle	205	Spatel 31, 59 – 62, 69 – 72, 77 – 82, 154, 196		Vitreoretinal Faßzange	122, 123
Rasierklinge	166	Spencer Ligaturschere	152	Vitreoretinal Kanüle	206
Referenzmarkierer	193	Spülhandgriff	198, 209, 211	Vogt Messspatel	196
Remky Zügelnahtpinzette	128	Spülkanüle	199, 200, 207, 208	Von Barsewisch Vorderkammerpinzette	96
Rentsch Linsenmanipulator	67	St. Martin Nahtpinzette	115	Vorderkammer-Kanüle	208
Repositionshäkchen	63	Starlöffel	54	Vorderkammer-Pinzette	96
Repositionsspatel	80, 77	Starmesser	47	Vorderkammer-Spülkanüle	207
Retrobulbare Kanüle	206	Starnadel	49	Vorderkammer-Spülset	210
Rolf Tränensacksonde	180	Steinert Implantationspinzette	103	Vorlagerungspinzette	129
Rollet Meißel für Tränensack	182	Sterilisierbehälter	213 – 216		
Rollet Tränensackhäkchen	27	Stern-Castroviejo Nahtpinzette	115	<b>W</b> Walker Hornhautschere	142
Rosen Kernspalter	72, 73	Stevens Sehnenschere	151	Walton Hohlmeißel	50
Rosen Nukleusspalter	73	Stevens Tenotomiehäkchen	29	Watzke Bandspreizpinzette	121
<b>S</b> Sato Hornhautmesser	48	Stevenson Wundspreizer	23	Weber Drahtschlinge	83
Sauer Lidsperrerr	20	Strabismusschere	150	Wecker Iridektomieschere	132
Sauer Nahtpinzette	116	Sub Tenon Anästhesie Kanüle	202, 203	Wecker Irisspatel	61
Saug- & Spülkanüle	199	Suker Zyklodialysespatel	82	Weiss Lidsperrerr	10
Saughandgriff	198	Synechienspatel	78	Wells Enukleationslöffel	83
Saupe Cilienpinzette	121	<b>T</b> Tennant Fadenpinzette	108	Welsh Kortex Saugkanüle	202
Sautter Luftkanüle	203	Tenotomiehäkchen	29	West Flachmeißel	182
Sautter Orbitalspatel	31	Textilfilter	215	West Hohlmeißel	182
Schaaf Fremdkörperpinzette	121	Thornton Fixiering	32	Westcott Sehnenschere	136, 139, 140
Schepens Lokalisator	25	Thornton Hornhautmarkierer	191	Wheeler Diszissionsmesser	47
Schepens Orbitalretraktor	31	Tokuda Kernspalter und Separator	75	Wilder Dilatator	180
Schere	131 – 152	Tonometer	196	Williams Lidsperrerr	8
Schielhaken	29	Tooke Hornhautmesser	49	Wills Hospital Allzweckpinzette	92
Schioetz Tonometer	196	Trabekular-Sonde	178	Wiltfang Lidsperrerr	14, 18
Schlingeninstrument	73	Tränensackhäkchen	27	Wright Fasziennadel	180
Schlingenkanüle	200	Tränensacksonde	180	Wundhaken	28
Schocket Lokalisator	25	Tränenweg Intubations Set	179	Wundspreizer	22 – 23
Scott Lidsperrerr	21	Tränenwegkanüle	204 – 206		
Sehnenschere	136 – 140, 151	Tränenwegsondenkanüle	204, 205	<b>Y</b> Y-Linsenmanipulator	67
Seibel Hornhaut-Flap-Spatel und Repositionsspatel	77	Trephine	55, 56	<b>Z</b> Ziegler Cilienpinzette	121
Shammas Kapselpolierer	201	Trephinen-Giff	57	Ziegler Diszissionsmesser	48
Sheets Schlingenkanüle	200	Troutman Kanüle	202	Zirkel	188, 189
Shepard Linsenimplantationspinzette	103	Troutman Linsenspatel	70	Zügelnahtpinzette	128
Sichel-Wilder Dilator	181	Troutman Mikro-Fadenpinzette	107, 108, 157	Zürich Modell, Nahtpinzette	116
Silikonball	210	Troutman Mikro-Hornhautpinzette	118	Zyklodialyse Kanüle	203
Simcoe Hinterkapselpolierer	201	Troutman Mikro-Hornhautschere	143	Zyklodialysespatel	82
Simcoe Kapselpolierer	201	Troutman Mikro-Klingenhalter	166		
Simcoe Kortex Extraktor	202	Troutman Mikro-Nadelhalter	167, 168		
Simcoe Saug- und Spülkanüle	199	Troutman Muskelpinzette	124, 128		
		Troutman Barraquer Hornhautschere	143		
		Troutman Barraquer Irisspatel	61		

## English

English	Page	English	Page	English	Page
<b>A</b>					
Adson Dressing Forceps	93	Bishop-Harmon Anterior Chamber Irrigator	207	Castroviejo Tying Forceps	107
Adson Utility Forceps	93	Bishop-Harmon Iris Forceps	87, 88	Catalano Lachrymal Intubation Set	179
Advancement Forceps	129	Blade Holder	162	Cataract Knife	47
Agricola Retractor	23	Blascovics Muscle Forceps	125	Cataract Needle	49
Air Injection Cannula	203	Blaydes Lens Implantation Forceps	103	Cauer Chalazion Forceps	124
Akahoshi Pre-Chopper	97	Blumental Conjunctiva Dissector	77	Chalazion Curette	52, 53
Amsler Needle for aqueous transplant	203	Bonaccolto Utility Forceps	94	Chalazion Forceps	124, 125
Anel Lachrymal Cannula	204	Bone Chisel	182	Chalazion Knife	46
Anesthesia Cannula	198, 199	Bone Gouge	182	Chang-Liebermann Micro Finger	76
Anis Corneal Marker	191	Bonn Iris Scissors	148	Charleux Irrigation/Aspiration Cannula	207
Anis Cortex Extractor	202	Bonn model Iris Forceps	84, 90, 91	Chayet LASIK Corneal Marker	192
Anis Nucleus Manipulator	65	Bonn model Mikro-Iris Hook	60	Chu Eye Speculum with Aspiration	19
Anis Suture Marker	191	Bores Corneal Fixation Forceps	119	Cilia Forceps	121
Anterior Chamber Irrigator	207, 208	Bores Corneal Marker	190, 191	Citelli Rongeur	181
Anterior Chmaper Forceps	96	Bowman Discission Needle	50	Clark Eye Speculum	8
Arlt Lens Loop	83	Bowman Lacrymal Probe	179	Clayman Lens Implantation Forceps	103
Arruga Capsular Forceps	94	Bracken Iris Forceps	88	Clayman Nucleus Rotator	65
Arruga Needle Holder	174	Brauweiler Aspirating Handpiece	198	Conjunctival-flap Forceps	119
Aspirating Handpiece	198	Braunstein Marker	189, 195	Cook Eye Speculum	20
Aspiration Cannula	199	Brinkhorst Cannula	199	Corbett Foreign body needle	51
Atticus Punch	181	Bucher-Kansas Nucleus Trisector	75	Corbin Sub Tenon Anesthesia Cannula	202
Aubaret Hook for Lacrimal Sack	27	Bunge Evisceration Spoon	54	Corcelle Eye Speculum	8
Axenfeld Chalazion Curette	53	Buratto LASIK Cannula	208	Corneal Fixation Forceps	114, 115, 154
Axenfeld Hook	27	Buratto LASIK Flap Forceps	120	Corneal Forceps	117 – 119, 158
Axenfeld Retractor	22	Buratto LASIK Flap protector	81	Corneal Knife	48, 49
Ayer Chalazion Forceps	124	Buratto Lens Forceps	105	Corneal Marker	190 – 193
				Corneal Scissors	140 – 145
		<b>C</b>		Corneal Suturing Forceps	113
		Caliper	184	Corneal Trephine	55, 56
<b>B</b>		Caliper	188, 189	Corneoscleral Punch	185
Backhaus Towel Forceps	130	Camelin LASEK Alcohol Well	80	Cortex Extractor	202
Bangerter Eye Speculum	22	Cannula	199 – 208	Corydon Capsulorhexis Forceps	99, 101
Bangerter Lachrymal Probe Cannula	204	Cannula with Collar Button	200	Cranz Irrigator	206
Bangerter Muscle Clamp	128	Cannula with Olive Tip	202	Crowford Intubation Set	179
Bangerter Retrobulbar Cannula	206	Capsular Forceps	94, 95	Crozafof MICS Capsulorhexis Forceps	98
Bangerter Spatula	60, 82	Capsular Punch	184	Culler Iris Spatula	61
Barkan Goniotomy Knife	48	Capsule Fragment Forceps	102	Culler Muscle Hook	29
Barraquer Blade Holder	166	Capsule Polisher	201	Cyclodialysis Cannula	203
Barraquer Cilia Forceps	121	Capsule Scissors	134	Cyclodialysis Spatula	82
Barraquer Corneal Scissors	140	Capsule Tag Forceps	96		
Barraquer Eye Speculum	12, 13	Capsulorhexis Forceps	97 – 101, 161 – 163		
Barraquer Iris Scissors	132	Carter Sphere introducer	184	<b>D</b>	
Barraquer Iris Spatula	61	Castroviejo Corneal Trephine	55	Dardenne Fragment Forceps	105
Barraquer Keratoplasty Knife	55	Castroviejo Caliper	188	Dastoor Conjunctival-flap Forceps	119
Barraquer Micro-Needle Holder	170 – 173	Castroviejo Capsular Forceps	94	Dastoor Superior Rectus Forceps	128
Barraquer Micro-Suture Forceps	112	Castroviejo Corneal Scissors	140, 142, 144	Dastoor Suture Forceps	112, 116
Barraquer Suture Forceps	112	Castroviejo Cyclodialysis Spatula	82	Daviel Lens Spoon	54
Barraquer-Troutman Micro Needle Holder	167	Castroviejo Dilatator	180	Degree Gauge and Fixation Ring	32
Barraquer Tying Forceps	106	Castroviejo Eye Speculum	22	Descement's Membrane Punch	185
Barraquer-Colibri-Forceps	112	Castroviejo Fixation Forceps	127	Desmarres Chalazion Forceps	124
Barraquer-Oosterhuis Eye Speculum	11	Castroviejo Iris Scissors	132	Desmarres Lid Retractor	24
Barraquer-Oosterhuis-Kratz Eye Speculum	11	Castroviejo Micro-Needle Holder	160, 167 – 169	Diamond Knife	36 – 45
Barrett Speculum	8	Castroviejo Micro-Scissors	145	Dieffenbach Serrefine	130
Beaupré Cilia Forceps	121	Castroviejo Needle Holder	175	Dilator	180
Beehler Dilator	26, 27	Castroviejo Scissors	144	Discission Knife	47, 48, 50
Beer Cilia Forceps	121	Castroviejo Spatule	78	Dodick Irrigating Nucleus Splitter	73, 76
Berke Ptosis Clamp	128	Castroviejo Suture Forceps	113 – 115, 160	Dodick Nucleus Cracker	96
Beyer Atticus Punch	181	Castroviejo Trephine	55	Dressing Forceps	88, 92, 93

## English

English	Page	English	Page	English	Page
Drysdale Lens Manipulator	66	Gill Corneal Knife	49	Hook for Lacrimal Sack	27
DSAEK Descement Spatula	79	Gill Iris Forceps	89	Hunt Chalazion Forceps	124
DSAEK Glide Spatula	79	Gill-Botvin Iris Forceps	89	Hydrodissection Cannula	203
DSAEK Forceps	120	Gill-Hess Iris Forceps	89		
Dulaney LASIK Corneal Marker	192	Gill-Hess Micro-Iris Forceps	89		
		Gills Irrigation-Aspiration Cannula	195	<b>I</b> Implantation Forceps	103
<b>E</b> Elevator	184	Gimbel LASIK Fixation Ring	32	Inamura Capsulorhexis Forceps	98
Elschnig Fixation Forceps	126	Gimbel LASIK Cannula	208	Incision Caliper	189
Entropium Forceps	128	Girard Synechia Spatula	78	Infusion Handle	211
Enucleation Scissors	152	Glaucoma Forceps	95	Injection Cannula	200
Enzyme Cannula	201	Goldstein Retractor	23	IOL Inserting Forceps	103
Erhardt Lid Forceps	125	Golf Club Foreign Body Spud	51	IOL Manipulator	66, 154
Ernest Nucleus Cracker	96	Goniotomy Knife	48	Iris Forceps	86 – 91, 160
Evisceration Spoon	54	Gonnin-Amsler Marker	196	Iris Hook	60, 67, 155
Eye Scissors	149	Gradle Cilia Forceps	121	Iris Retractor	60
Eye Speculum	8 – 22	Graefe Cataract Knife	47	Iris Scissors	132, 146
		Graefe Fixation Forceps	125	Iris Spatula	60 – 62
		Graefe Iris Hook	60	Irrigating Cannula	200, 207
<b>F</b> Faulkner Lens Holding Forceps	105	Graefe Lens Spoon	54	Irrigating Handpiece	198
Fascia Needle	180	Graefe Scarifier	47	Irrigating Nucleus Splitter	76, 77
Fechtner Conjunctiva Forceps	120	Graefe Strabismus Hook	28	Irrigating Vectis Cannula	200
Filter	215	Graether Cannula	200	Irrigation-Aspiration Cannula	199
Fine-Thornton Fixation Ring	32	Graether Iris Retractor	60		
Fink Muscle Hook	26	Grasping Forceps	95	<b>J</b> Jaeger Spatula	26
Fixation Forceps	125, 126	Green Fixation Forceps	126	Jaeger Strabismus Hook	29
Fixation Hook	26	Green Strabismus Hook	29	Jaffe Capsulorhexis Forceps	97, 162
Fixation Ring	32	Gross Sub Tenon Anesthesia Cannula	203	Jaffe Lens Spatula	69
Flap Lifter & Retreatment Spatula	77	Guimaraes LASIK Spatula	81	Jaffe Lid Retractor	24
Flieringa Fixation Ring	32	Guthrie Fixation Hook	26	Jaffe Tying Forceps	109
Folding Forceps	104			Jaffe-Bechert Lens Nucleus Rotator	65
Forceps	156 – 162, 86 – 129	<b>H</b> Haberer McPherson	105	Jameson Advancement Forceps	129
Foreign-Body Forceps	123	Haeflinger Phaco Splitter	74	Jameson Caliper	189
Foreign-Body Gouge	50	Haemostatic Forceps	130	Jameson Strabismus Hook	28
Foreign-Body Needle	50 – 52	Halsted-Mosquito Haemostatic Forceps	130	Jayle Suture Forceps	112
Foreign-Body Remover	184	Harms Trabecular Probe	178	Jensen Capsule Polisher	201
Foreign-Body Spud	51, 52	Harris-Sinsky Lens Manipulation Hook	64	Jewelers Forceps	110, 111
Fragment Forceps	104, 105, 158	Hartmann Haemostatic Forceps	130	Johnson-Tooke Corneal Knife	49
Francis Chalazion Forceps	125	Hartmann-Halle Nasal Speculum	183	Jones Towel Clamp	130
Francis Foreign-Body Spud	51	Healon Injection Cannula	200	Jünemann Lacrymal Probe Cannula	205
Frankel Eye Speculum	17	Hebra Chalazion Curette	52		
Freer Bone Chisel	182	Heiss Lacrimal Sac Retractor	23	<b>K</b> Kalt Needle Holder	174
Freer Twin Elevator	182	Helveston Strabismus Hook	29 – 30	Kansas Nucleus Bisector	75
Frenzl Lens Manipulating Hook	67	Helveston Tying Forceps	110	Kansas Nucleus Removal Forceps	105
Friedmann Rongeur	183	Helveston Retractor	25	Katzen LASIK Corneal Spatula	81
Fukasaku Anesthesia Cannula	202	Henderson Corneal Marker	193	Katzin Micro-Corneal Scissors	143
Fukasaku Irrigating Nucleus Splitter	77	Henderson Degree Gauge	193	Keener Lens Divider	75
Fukasaku LASIK Cannula	208	Henderson Alignment Marker	193	Kellnar Trabecular Probe	178
Fukasaku LASIK Spatula	81	Henry Cilia Forceps	121	Kelly Descemements Membrane Punch	185
		Hess Iris Forceps	89	Kelman-McPherson	
		Hirschman Lens Spatula	69	Micro-Tying Forceps	106, 157 – 159
<b>G</b> Gaskin Fragment Forceps	104, 105, 158	Hoffer Corneal Marker	190	Kelman-McPherson Suture Forceps	117, 156
Gass Corneoscleral Punch	185	Hoffer-McPherson Suture Forceps	117	Keratometer	192
Gass Retinal Detachment Hook	28	Hofmann-Thornton Fixation Ring	32	Keratoplasty Knife	55
Gass Sclera Marker	25	Holding and Folding Forceps	184	Keratoplasty Spatula	82
Gianetti MICS Capsulorhexis Forceps	98	Holth Capsular Punch	184	Kerrison Rongeur	181
Gießen Dilator	181	Hook	26 – 30, 63, 64, 79	Kershner Eye Speculum	16





## English

English	Page
Pre-Chopper	97
Probe for Lachrymal Sack	180
Pterygium Knife	47
Ptosis Clamp	128

<b>R</b>		
Radial Keratotomy Incision		
Irrigating Cannula	207	
Randolph Cyclodialyse Cannula	203	
Razor Blade	166	
Remky Superior Rectus Forceps	128	
Rentsch Lens Manipulator	67	
Reposition Hook	63	
Retinal Detachment Hook	28	
Retractor	24, 25, 31	
Retrolubar Cannula	206	
Rolf Probe for Lachrymal Sac	180	
Rollet Hook for Lachrymal Sack	27	
Rollet Rugine for Lachrymal Sack	182	
Rongeur	181, 183	
Rosen Irrigating Nucleus Splitter	72	
Rosen Nucleus Dividing Hook	73	
Rugine for Lachrymal Sack	182	
Ruler	195	

<b>S</b>		
Sato Corneal Knife	48	
Sauer Eye Speculum	20	
Sauer Suture Forceps	116	
Saupe Cilia Forceps	121	
Sautter Air Injection Cannula	203	
Sautter Orbital Spatula	31	
Scalpel handle	57	
Scarifier	47	
Schaaf Foreign-Body Forceps	121	
Schepens Orbital Retractor	31	
Schioetz Tonometer	196	
Schocket Localisator	25	
Scissors	131 – 152	
Sclera Marker	25	
Sclerectomy Scissors	152	
Scott Eye Speculum	21	
Seibel Flap Lifter & Retreatment Spatula	77	
Serrefine	130	
Shammas Capsule Polisher	201	
Sheets Irrigating Vectis Cannula	200	
Shepard Lens Implantation Forceps	103	
Sichel-Wilder Dilator	181	
Silicone Bulb	210	
Simcoe Capsule Polisher	201	
Simcoe Cortex Extractor	202	
Simcoe Irrigating Nucleus Delivery Cannula	200	
Simcoe Irrigation-Aspiration Cannula	199	
Simcoe Posterior Capsule Polisher	201	
Simpson Dilator	177	
Sinsky Lens Manipulation Hook	63, 64, 154	
Sleeve Spreading Forceps	121, 122	
Slonae LASEK Spatula	80	

English	Page
Snellen Entropium Forcpes	128
Snellen Lens Loop	83
Spatula	31, 59 – 62, 69 – 72, 77 – 82, 154, 196
Specula	8 – 22
Spencer Stitch Scissors	152
St. Martin Suture Forceps	115
Steinert IOL Inserting Forceps	103
Sterilisation Case	213 – 216
Stern-Castroviejo Suture Forceps	115
Stevens Tenotomy Hook	29
Stevens Tenotomy Scissors	151
Stevenson Retractor	23
Stitch Scissors	152
Strabismus Hook	28, 29
Strabismus Scissors	150
Sub Tenon Anesthesia Cannula	202, 203
Suker Cyclodialysis Spatula	82
Superior Rectus Forceps	128
Suture and Conjunctiva Forceps	115
Suture Forceps	92, 112 – 117, 158 – 160
Suture Marker	191
Swiss Model, Blade Holder	166
Swiss Modell, Capsular Forceps	94
Synechia Spatula	78

<b>T</b>		
Tennant Tying Forceps	108	
Tenotomy Hook	29	
Tenotomy Scissors	136, 139, 140, 151	
Textile Filter	215	
Thornton Corneal Marker	191	
Thornton Fixation Ring	32	
Tokuda Nucleus devider and separator	75	
Tonometer	196	
Tooke Corneal Knife	49	
Towel Clamp	130	
Trabecular Probe	178	
Trephine	55, 56	
Trephine Handle	57	
Troutman Cannula	203	
Troutman Lens Spatula	70	
Troutman Micro-Blade Holder	166	
Troutman Micro-Corneal Forceps	118	
Troutman Micro-Corneal Scissors	143	
Troutman Micro-Needle Holder	167, 168	
Troutman Micro-Tying Forceps	107, 108, 157	
Troutman Superior Rectus Forceps	128	
Troutman-Barraquer Corneal Scissors	143	
Troutman-Barraquer Iris Spatula	61	
Troutman-Barraquer Micro-Needle Holder	173	
Tübingen Model, Micro Scissors	135	
Tübingen Modell, Air Injection Cannula	203	
Twin Elevator	184	
Tying Forceps	106 – 111	

<b>U</b>		
Urrets-Zavalía,		
Fixation Pick and Depressor	196	

English	Page
Uthoff Capsule Scissors	134
Uthoff Reposition Hook	63
Utility Forceps	92 – 94
Utrata Capsulorhexis Forceps	97, 101, 161, 162

<b>V</b>		
Vannas Micro Scissors,		
Model Tübingen	133	
Vannas Micro-Scissors	133 – 135	
Vidaurri LASIK Cannula	208	
Vitreotomy Scissors	146, 147	
Vitreoretinal Grasping Forceps	122, 123	
Vogt Measuring Spatula	196	
Von Barsewisch Anterior Chamber Forceps	96	

<b>W</b>		
Walker Corneal Scissors	142	
Walton Foreign-Body Gouge	50	
Watzke Sleeve Spreading Forceps	121	
Weber Lens Loop, large	83	
Wecker Iris Scissors	132	
Wecker Iris Spatula	61	
Weiss Eye Speculum	10	
Wells Enucleation Spoon	83	
Welsh Cortex Aspirating Cannula	202	
West Bone Chisel	182	
West Bone Gouge	182	
Westcott Tenotomy Scissors	136, 139, 140	
Wheeler Discission Knife	47	
Wilder Dilator	180	
Williams Eye Speculum	8	
Wills Hospital Utility Forceps	92	
Wiltfang Eye Speculum with Aspiration	14, 18	

<b>Z</b>		
Ziegler Cilia Forceps	121	
Ziegler Discission Knife	48	
Zürich Model, Suture Forceps	116	



## Español

Español	Página
<b>A</b>	
Adson Pinza de Disección	93
Agrícola Separador	23
Aguja para Cuerpos Extraños	50 – 52
Akahoshi Pre-Chopper	97
Amsler Cánula para Punción	207
Anel Cánula para Canal Lacrimal	204
Anillo de Fijación	32
Anillo de Medición	191, 193
Anis Extractor para Corteza	202
Anis Manipulador para Nucleo de Lente	65
Anis Marcador para el Córnea	191
Anis Marcador para Sutura	191
Arlt Asa	83
Arruga Pinza de Capsular	94
Arruga Porta-aguja	174
Asa	68, 83
Aubaret Gancho para el Saco Lacrimal	27
Axenfeld Cucharilla para Chalazion	53
Axenfeld Gancho	27
Axenfeld Separador	22
Ayer Pinza de Chalazion	124
<b>B</b>	
Backhaus Pinza para Compresas	130
Bangerter Blefaróstató	22
Bangerter Cánula para Canal Lacrimal	204
Bangerter Cánula Retrobulbar	206
Bangerter Espátula	60, 82
Bangerter Espatula para Iris	60
Bangerter Pinza Clamp Muscular	128
Barkan Cuchillo para Goniotomía	48
Barraquer Blefaróstató	12, 13
Barraquer Cuchillo para Queratoplastia	55
Barraquer Espátula para Iris	61
Barraquer Micro-Porta-Aguja	170 – 173
Barraquer Pinza para Anudar	106
Barraquer Pinza para Depilación	121
Barraquer Pinza para Sutura	112
Barraquer Pinza-tijera para Iridectomia	132
Barraquer Pinza-tijera para la Córnea	140
Barraquer Porta Hoja	166
Barraquer-Oosterhuis Blefaróstató	11
Barraquer-Oosterhuis-Kratz Blefaróstató	11
Barraquer-Troutman Micro-Porta-Aguja	167
Beaupré Pinza para Depilación	121
Beer Pinza para Depilación	121
Berke Pinza Muscular para Ptosis	128
Beyer Pinza-gubia	181
Bishop Harmon Irrigador para Cámara Anterior	210
Bishop-Harmon Pinza para Iris	87, 88
Bisturi	36 – 46
Bisturi de Chalazión	46
Bisturi de Diamante	36 – 45
Blaydes Pinza	

Español	Página
para Implantación del Cristalino	103
Blefaróstató	8
Blefaróstató con Aspiración	18 – 19
Blumental Espatula para Conjuntiva	77
Bonaccolto Pinza Utility	94
Bonn Micro-Gancho para Iris	60
Bonn Pinza para Iris	90, 91, 160
Bores Marcador para el Córnea	190, 191
Bores Pinza de Fijación para Córnea	119
Bowman Aguja para discisión	50
Bowman Estilete Lacrimal	179
Bracken Pinza para Iris	88
Brauweiler Mango de Aspiración	198
Brinkhorst Cánula	199
Bucher-Kansas Gancho para Separación de Nucleo	75
Bunge Cucharilla para Exenteración	54
Buratto Cánula para LASIK	208
Buratto Pinza para IOL	105
Buratto Pinza para LASIK Flap	120
Buratto Protector de Cogajo	81
<b>C</b>	
Caja para Esterilización	214 – 216
Camellin Embudo de Alcohol	80
Cánula	198 – 210
Cánula con Botón en el Cuello	200
Cánula con Punta Oliva	202
Cánula para Aire	203
Cánula para Anestesia	202, 203
Cánula para Aspiración	199
Cánula para Cámara Anterior	204
Cánula para Canal Lacrimal	204 – 206
Cánula para Ciclodíálisis	203
Cánula para Enzima	201
Cánula para Inyección	200
Cánula para Irrigación para queratotom radial	200, 208
Cánula para Irrigación y Aspiración	199, 207, 209, 210
Cánula para Lacrimal	204 – 206
Cánula para Punción	207
Cánula Retrobulbar	207
Castroviejo Blefaróstató	22
Castroviejo Cánula para Ciclodíálisis	203
Castroviejo Compás	188
Castroviejo Dilatador	180
Castroviejo Espátula	78, 82
Castroviejo Micro-Pinza para Sutura	113 – 115, 160
Castroviejo Micro-Porta-aguja	167 – 169
Castroviejo Mikro-Pinza-tijera	145
Castroviejo Pinza de Capsula	94
Castroviejo Pinza de Fijación	127
Castroviejo Pinza para Anudar	107
Castroviejo Pinza-tijera	144, 145
Castroviejo Pinza-tijera para Iridectomia	132

Español	Página
Castroviejo Pinza-tijera para la Córnea	140, 142, 144, 145
Castroviejo Porta-aguja	175
Castroviejo Trépano para la Córnea	55
Catalano Set de Intubación para Lacrimal	179
Cauer Pinza de Chalazion	124
Chang Liebermann Manipulador para núcleo de lente	76
Charleux Cánula para Irrigación o Aspiración	207
Chayet Marcador Corneal	
Aplicación LASIK	192
Chu Blefaróstató con Aspiración	19
Cinzel para el Sack Lacrimal	182
Citelli Pinza-gubia	181
Clark Blefaróstató	8
Clayman Pinza para Implantación del Cristalino	103
Clayman Rotator para Nucleo	65
Compás	188, 189
Compás para Incisión	189
Cook Blefaróstató	20
Corbett Aguja para cuerpos extraños	51
Corbin Sub Tenon Cánula para Anestesia	202
Corcelle Blefaróstató	8
Corydon Pinza para Capsulorhexis	101
Cranz Irrigador	206
Crawford Set de Intubación de Lente	179
Crozafof MICCS Pinza Capsulorhexis	98
Cucharilla	53 – 54
Cucharilla para catarata	47, 54
Cucharilla para chalazion	52, 53
Cucharilla para evisceración	54
Cuchillo para Cataratas	47, 54
Cuchillo para Discisión	47, 48
Cuchillo para Queratoplastia	55
Culler Espatula para Iris	61
Culler Gancho Muskular	29
<b>D</b>	
Dardenne Pinza de Fragmento	105
Dastoor Pinza para Conjuntiva	119
Dastoor Pinza para Estrabismo	128
Dastoor Pinza para Sutura	112, 116
Daviel Cucharilla para Catarata	54
Desmarres Pinza de Chalazion	124
Desmarres Retractor para Párpados	24
Dieffenbach Serra-Fina	130
Dilatador	180, 181
Disecador para la Córnea	49
Dodick-Karmann Gancho para Separación de Nucleo	93
Dodick Separador para Nucleo del Cristalino	96
Draeger Pinza para Conjuntiva	120
Drysdale Manipulador para Nucleo de Lente	66
Dulaney Marcador para Corneal Aplicación LASIK	197

## Español

Español	Página	Español	Página	Español	Página
<b>E</b> Elevador	184	Gießen Dilatador	181	Jaffe Espátula para el Cristalino	69
Elschnig Pinza de fijación	126	Gill Pinza para Iris	89	Jaffe Pinza Capsulorhexis	97, 162
Erhardt Pinza para Párpados	125	Gill Queratótomo	49	Jaffe Pinza para Anudar	109
Ernest Separador		Gill-Hess Micro-Pinza para Iris	89	Jaffe Retractor para Párpados	24
para Nucleo del Cristalino	96	Gills Cánula para Irrigación y Aspiración	199	Jaffe-Bechert Rotator	
Escarificador	47	Gills-Welsh Cánula		para Nucleo de Lente	65
Espátula	60 – 83, 154	para Irrigación y Aspiración	199	Jameson Compas	189
Espátula orbital	31	Gimbel Cánula para LASIK	208	Jameson Gancho para Estrabismo	28
Espátula para Ciclodíalisis	87	Girard Espátula para Synechiae	78	Jameson Pinza	
Espátula para el Cristalino	70 – 72, 154	Goldstein Separador	23	para Avanzamiento Muscular	129
Espátula para Enuclación	83	Golf Club Aguja para Cuerpos Extraños	51	Jayle Pinza para Sutura	112
Espátula para Iris	60 – 62	Gonnin-Amsler Marcador	196	Jensen Pulidor para Cápsula	201
Espátula para LASIK	77, 81	Gradle Pinza para Depilación	121	Johnson-Tooke Queratótomo	49
Espátula para Queratoplastia	82	Graefe Cucharilla para Catarata	54	Jones Pinza para Compresas	130
Espátula para Synechiae	78	Graefe Cuchillo para Cataratas	47	Jünemann Cánula para Canal Lacrimal	205
Espéculo nasal	183	Graefe Gancho para Estrabismo	28		
Estilete Lacrimal	179, 180	Graefe Gancho para Iris	60	<b>K</b> Kalt Porta-aguja	177
Estilete Trabecularderecho	178	Graefe Pinza de Fijación	125	Kansas Gancho	
Expresor	68	Graether Cánula	200	para Separación de Nucleo	75
		Graether Retractor para Iris	60	Kansas Pinza para Fragmentos	105
<b>F</b> Faulkner Pinza para Lentes	105	Green Gancho para Estrabismo	29	Katzen LASIK Espatula	
Fechner Pinza para Conjunctiva	120	Green Pinza de fijación	126	para Colgajo de Cornea	81
Filtro de Textil	215	Gross Sub Tenon Cánula para Anestesia	208	Katzin Micro-Pinza-tijera	143
Fine Thornton Anillo de Fijación	32	Guimaraes Espatula para LASIK	81	Keener Asa para Separación de Lente	75
Fink Gancho Muscular	26	Guthrie Gancho doble para Fijación	26	Kellnar Estilete Trabeculares	178
Flieringa Anillo de Fijación	32			Kelly Sacabocado	185
Francis Instrumento		<b>H</b> Haeflinger Gancho		Kelman-McPherson	
para Cuerpos Extraños	51	para Separación de Nucleo	74	Micro-Pinza para anudar	106, 156, 157
Francis Pinza de Chalazion	125	Halsted-Mosquito Pinza Hemostática	130	Kelman-McPherson	
Freer Cíncel	182	Harms Estilete Trabeculares	178	Pinza para Sutura	117, 159
Freer Disector y Elevador	184	Harris-Sinsky Gancho		Kerrison Pinza-gubia	181
Frenzl Gancho para		para Manipulación de Lente	64	Kershner Blefaróstato	16
Manipulación de Lentes	67	Hartmann Pinza Hemostática	130	Kimura Espatula	77
Friedmann Pinza Gubia	183	Hartmann-Halle Espéculo nasal	183	Kirby Asa	68, 83
Fukasaku Cánula para Anestesia	202	Healon Cánula para Inyección	200	Kirby Cucharilla	68
Fukasaku Cánula para LASIK	208	Hebra Cucharilla para Chalazion	52	Kirby Expresor	68
Fukasaku Espatula para LASIK	81	Heiss Separador para el Saco Lacrimal	23	Kirby Pinza para Fijación	127
Fukasaku Gancho		Helveston Gancho para Estrabismo	29, 30	Knolle Espátula para el Cristalino	69
para Separación de Nucleo	73, 75	Henry Pinza para Depilación	121	Knolle-Pearce Lazo para Irrigación	200
		Hess Pinza para Iris	89	Knorz Blefaróstato con Aspiración	19
<b>G</b> Gancho de Reposición	63	Hevelston Pinza para anudar	110	Koch Espátula para el Cristalino	70
Gancho Muscular	26	Hirschman Espátula para el Cristalino	64, 69	Koch Mango de Aspiración	194
Gancho para Desprendimde Retina	28	Hoffer Marcador para la Córnea	190	Kraff Pinza para Capsular	96
Gancho para el Cristalino	68	Hoffer-McPherson Pinza para Sutura	117	Kratz Blefaróstato	10, 13
Gancho para el Saco Lacrimal	27	Hofmann-Thornton Anillo de Fijación	32	Kratz Pulidor para Cápsula	201
Gancho para Estrabismo	28 – 30	Holth Punzón Capsular	184	Kratz-Barraquer Blefaróstato	10, 11
Gancho para Manipulación de Lente	63, 64, 67	Hunt Pinza de Chalazion	1204	Kuglen Manipulador de Iris	67
Gancho para Separación				Kuhnt Legra para la Córnea	49
de Nucleo	71, 72, 73, 74, 75, 76, 77	<b>I</b> Inamura Pinza Capsulorhexis	98		
Gancho para Tenotomía	29	Instrumento de medición		<b>L</b> La Force Instrumento	
Gaskin Pinza de Fragmento	104, 105, 158	en grado y Anillo de Fijación	32	para Cuerpos Extraños	51
Gass Gancho		Irrigador para Cámara Anterior	208, 210	Lagrange Tijera para Esclerectomía	152
para Desprendimiento de Retina	28			Lambert Pinza de Chalazion	124
Gass Marcador para Sclera	25			Lancaster Blefaróstato	8
Gass Punzón	185	<b>J</b> Jaeger Gancho para Estrabismo	29	Laqua Localizador	25
Gianetti MICS Pinza Capsulorhexis	98	Jaeger Placa para Párpados	26		

## Español

Español	Página	Español	Página	Español	Página
Lazo para Irrigación	200	Mead Martillo	182	Paul Separado	28
Legra para la Córnea	49	Mellinger Blefaróstató	9	Pierse Micro-Pinza para Fijación	118, 161
Lehner Pinza para Capsulorhexis	97, 163	Mellinger Blefaróstató		Pierse-Colibri Pinzas para Córnea	118
Lester Gancho		Mendez Anillo de Medición	191	Pigtail Estilete de Lacrimal	180
para Manipulación de IOL	66, 154	Mendez Marcador para	192	Pinza Capsular	94, 96
Lester Pinza de Fijación	126	Mermoud Pinza para Trabeculectomía	95	Pinza Capsulorhexis	97 – 101,, 161 – 163
Lester-Burch Blefaróstató	8	Meyhoefer Cucharilla para Chalazion	53	Pinza Clamp Muscular	128
Levinson Aguja para Cuerpos Extraños	50	Micro Finger Gancho		Pinza de Chalazion	124, 125
Lewicky Cánula para Cámara Anterior	208	para Separación de Nucleo	74, 76	Pinza de Disección	92
Lewicky Gancho para		Micro-Gancho para Iris	60	Pinza de Fijación	119, 125 – 127
Manipulación de Lente	64	Micro-Pinza para Anudar	106 – 110, 157	Pinza de Fragmento	104, 105, 158
Liebermann Blefaróstató	14, 15, 17	Micro-Pinza		Pinza Gubia	181
Liebermann Blefaróstató		para Fijación	118, 161	Pinza Hemostática	130
con Aspiración	18	Micro-Pinza para Iris	89 – 91, 160	Pinza Muscular para Ptosis	128
Liebermann Micro Finger	74	Micro-Pinza para la Cornea	118	Pinza para Anudar	106 – 110, 156, 157
Livernois Pinza para Lentes	106	Micro-Pinza para Sutura	112, 115	Pinza para Avanzamiento Muscular	129
Livernois Pinza para Tomar y Plegar	104	Micro-Pinza-tijera	141, 143, 145	Pinza para Compresas	130
Localizador	25	Micro-Porta Hoja	166	Pinza para Conjuntiva	119
Lordan Pinza de Chalazion	124	Micro-Porta-aguja	163 – 173	Pinza para Cornéa	117, 119, 158
Lu Marcador de Corneal aplicación LASIK	192	MICS Pinza Capsulorhexis	98, 99	Pinza para Cuerpos Extraños	121
Luntz-Dodick Punzon		Modelo Tübingen Vannas Micro-Tijera		Pinza para Depilación	121
para Trabeculectomía	185	para Cataracta	135	Pinza para Entropión	128
<b>M</b> Mackensen Estilete Trabeculares	178	Modelo Zürich Pinza para Sutura	116	Pinza para Estrabismo	128
Maddox Espátula para LASIK	81	Moehle Pinza para la Córnea	117	Pinza para Fijación	118, 126 – 128, 161
Maloney Gancho		Moody Pinza de Fijación	126	Pinza para Fragmentos	106
para Manipulación de IOL	66	Moorfield Pinza para Sutura y Conjuntiva	119	Pinza para Implantación	103
Maloney Keratometer	192	Mueller Separador	23	Pinza para IOL	139
Mango de Aspiración	198	Murdock Blefaróstató	20	Pinza para Iris	86 – 91, 160
Mango de bisturí	57	<b>N</b> Nagahara Gancho		Pinza para Lentes	105, 106
Mango de Irrigación	198, 211	para Separación de Nucleo	74	Pinza para Párpados	125
Mango para trépano	56, 57	Neuhann Gancho		Pinza para Plegar	104
Manipulador de Lentes	67	para Separación de Nucleo	71	Pinza para Sujetar el Cristalino	105
Manipulador para Nucleo de Lente	65, 66	New Orleans Asa	83	Pinza para Sutura 110 – 117, 119, 158 – 160	
Mannis-Buratto Protector		Noyes Pinza-tijera para Iridectomia	132	Pinza para Sutura, modelo Zürich	116
de Colgajo para LASIK	81	Nugent Pinza utility	94	Pinza para Vitreoretinal	122, 123
Marcador	189 – 196	<b>O</b> O'Gawa Cánula		Pinza Tipo Joyero	110, 111
Marcador para el Córnea	191, 194	para Irrigación y Aspiración	199	Pinza Utility	92, 94
Marcador para Sclera	25	Obstbaum Espátula para el cristalino	69	Pinza-gubia	181
Marcador para Sutura	191	Ong Tijera para Cápsula	134	Pinza-tijera para cataracta	133 – 135, 139
Martillo	182	Osher Compás para Incisión	189	Pinza-tijera para Iridectomia	148
Masket Pinza Capsulorhexis	100, 162	Osher Gancho para manipulación de Lentes	67	Pinza-tijera para la Córnea	140 – 145
Mawas Retractor para Iris	60	Osher Pinzas para Iris	89	Pinza-tijera para Sinequia Anterior	144
McCullough Pinza de Disección	92	Osniaka-Faulkner Pinza		Pinza-tijera para Tenotomía	136, 139, 140
McDonald Pinza para Plegar	104	para Sujetar el Cristalino	105	Pisacano Rotator para Nucleo de Lente	65
McIntyre Cánula		<b>P</b> Panas Pinza de Fijación	125	Placa de presión	146
para Irrigación y Aspiración	199	Park Blefaróstató	21	Placa para Párpados	26
McIntyre Cánula para Lacrimal	205	Park-Guyton Blefaróstató	21	Plange Aguja para Cuerpos Extraños	51
McIntyre Irrigador para Cámara Anterior	208	Park-Maumenee Blefaróstató	21	Pley Blefaróstató	16
McIntyre Mango para Irrigación	211	Paton Disecador para la Córnea	49	Polack Pinza par Sutura	113
McIntyre-Brinkhorst Cánula	200	Paton Espátula para Queratoplastia	82	Porta Hoja	57, 166
McPherson Micro-Pinza		Paton Porta-aguja	174	Porta-Aguja	163, 167 – 175
para Anudar	107, 109, 157	Paufique Cuchillo para Queratoplastia	55	Pre-Chopper	97
McPherson Pinza para Cornéa	117, 119, 158	Paufique Pinza para Anudar	111	Pulidor para Cápsula	201
McPherson Porta-Aguja	172	Paufique Pinza para Sutura	115	Punzón para trabeculectomia	185
McPherson-Westcott Pinza-tijera				Punzón Capsular	184
para tenotomía	139				

## Español

Español	Página
<b>Q</b> Queratónimo	48, 49
<b>R</b> Randolph Cánula para Ciclodíalisis	203
Reglilla	189, 196
Remky Pinza para Superior Rectus	128
Rentsch Manipulador de Lentes	67
Retractor Orbital	31
Retractor para Iris	60
Retractor para Párpados	127
Rolf Estilete par el Saco Lacrimal	180
Rollet Cíncel para el Saco Lacrimal	182
Rollet Gancho para el Saco Lacrimal	27
Rosen Gancho	
para Separación de Nucleo	72, 73, 76
Rotator para Nucleo de Lente	65, 67, 72
Sato Queratónimo	48
Sauer Blefaróstato	20
Sauer Pinza para Sutura	116
Saupe Pinza para Depilación	121
Sautter Cánula para Aire	203
Sautter Espátula Orbital	31
Schaaf Pinza para Cuerpos Extraños	121
Schepens Localizador	25
Schepens Retractor Orbital	31
Schioetz Tonómetro	196
Schocket Localizador	25
Scott Blefaróstato	21
Seibel Espatula para LASIK	77
Separador	25
Separador para el Saco Lacrimal	22, 23
Separador para Nucleo del Cristalino	96
Serra-Fina	130
Shammas Pulidor para Cápsula	201
Shapira Blefaróstato	
Sheets Lazo para Irrigación	200
Shepard Pinza para	
Implantación del Cristalino	103
Sichel-Wilder Dilatador	181
Simcoe Cánula para	
Irrigación y Aspiración	199
Simcoe Cánula para	
Manipulación del Nucleo	200
Simcoe Extractor para Corteza	202
Simcoe Pulidor para Cápsula	201
Simcoe Pulidor para Cápsula posterior	201
Sinsky Gancho	
para Manipulación de Lente	63, 154
Sloane Espatula para LASEK	08
<b>S</b> in Asa	83
in Pinza para Entropión	128
Spencer Tijera para incisión	152
St. Martin Pinza para Sutura	115
Steinert Pinza para IOL	103
Stern-Castroviejo Pinza para Sutura	115
Stevens Gancho para Tenotomía	29

Español	Página
Stevens Sub Tenon Cánula para Anestesia	202
Stevens Tijera-tenótomo Corta	151
Stevenson Separador	23
Sub Tenon Cánula para Anestesia	202, 203
Suker Espátula para Ciclodíalisis	82
<b>T</b> Tennant Pinza para Anudar	108
Thornton Anillo de Fijación	32
Thronton Markador para la Córnea	191
Tijera Ocular	148
Tijera para Cápsula	134
Tijera para Enucleación	152
Tijera para Esclerectomía	152
Tijera para Estrabismo	150
Tijera para Incisión	152
Tijera para Iridectomía	132, 148
Tijera para Vitrectomía	146, 147
Tijera-tenótomo	151
Tokuda Gancho para Separación de Núcleo	75
Tonómetro	196
Tooke Queratónimo	49
Trépano para la Córnea	55, 57
Troutman Cánula	202
Troutman Espátula para el Cristalino	70
Troutman Micro-Pinza	
para Anudar	107, 108, 157
Troutman Micro-Pinza para la Cornea	118
Troutman Micro-Pinza-tijera	143
Troutman Micro-Porta Hoja	166
Troutman Micro-Porta-aguja	166, 168 – 170
Troutman Pinza para Estrabismo	128
Troutman-Barraquer Micro-Pinza-tijera	143
Troutman-Barraquer Micro-Porta-aguja	173
Troutman-Barraquer Spátula para Iris	61
<b>U</b> Urrets-Zavalía	
Punto de Fijación y Depressor	196
Uthoff Gancho de Reposición	63
Uthoff Tijera para Cápsula	134
Utrata Pinza	
para Capsulorhexis	97, 101, 161, 167
<b>V</b> Vannas Micro-tijera	133 – 135
Vidaurri Cánula para LASIK	208
Vogt Reglilla	196
Von Barsewisch	
Pinza con Cámara Anterior	96
<b>W</b> Walker Pinza-tijera para la Córnea	142
Walton Gubia	50
Watzke Pinzas para extender mangos	121
Weber Asa	83
Wecker Espatula	61
Wecker Pinza-tijera para Iridectomía	132

Español	Página
Weiss Blefaróstato	10
Wells Espátula para Enucleación	83
Welsh Cánula de Aspiración de Corteza	202
West Cíncel	1782
West Gubia	182
Westcott Pinza-tijera para Tenotomía	139, 140
Wheeler Cuchillo para Discisión	47
Wilder Dilatador	180
Williams Blefaróstato	8
Wills Hospital Pinza utility	92
Wiltfang Blefaróstato con Aspiración	18
Wright aguja de vendaje	180
<b>Z</b> Ziegler Cuchillo para Discisión	48
Ziegler Pinza para Depilación	121

## Français

Français	Page	Français	Page	Français	Page
<b>A</b>		Beyer Emporte-pièce	181	Castroviejo Pince à suture	113 – 115, 160
Adson Pince à conjonctive	93	Bishop-Harmon Irrigateur pour la chambre antérieure	210	Castroviejo Pince capsulaire	94
Adson Pince à disséquer	93	Bishop-Harmon Pince à iris	87, 88	Castroviejo Pince-ciseaux à iridectomie	132
Agricola Ecarteur pour le sac lacrymal	23	Bissecteur de noyau	75	Castroviejo Pince-ciseaux pour synéchie antérieure	144
Aiguille	49 – 52	Bistouri	36 – 46	Castroviejo Porte-aiguille	175
Aiguille à cataracte	49	Bistouri à chalazion	46	Castroviejo Spatule doubles	78
Aiguille à corps étrangers	50, 51, 52	Blaydes Pince pour implantation lentille cristalline	103	Castroviejo Spatule pour cyclodialyse	82
Aiguille à dissection	50	Blépharostat	8 – 22	Castroviejo Trepan conéen	55
Akahoshi Pre-Chopper	97	Blepharostat avec aspiration	18, 19	Castroviejo, Porte-lame de rasoir	166
Anel Canule à voie lacrymal	204	Blumental Spatule pour conjonctive	77	Catalano jeu pour conduits lacrymaux	179
Anis Crochet manipulateur	65	Boîte pour stérilisation	214 – 216	Cauer Pince à chalazion	124
Anis Extracteur de cortex	202	Bonaccolto Pince utility	94	Chang-Liebermann Mikro-Finger	76
Anis Marqueur pour la cornée	191	Bonn Pince à iris	90, 91, 160	Charteux Canule à irrigation	207
Anneau de Fixation	32	Bores Anneaux marqueur	115	Chayet LASIK marqueur pour la cornée	192
Anneau de fixation LASIK	33	Bores Marqueur	190, 191	Chu Blepharostat avec aspiration	19
Anneaux marqueur	190	Boucle de lavage	200	Ciseau-burin pour le sac lacrymal	182
Anneaux marqueur avec croix de centrage	190	Bowman Aiguille à dissection	50	Ciseaux à enucléer	152
Anse	68, 83	Bowman Stylet lacrymal	179	Ciseaux à sclérectomie	152
Anse à lentilles avec irrigation	200	Bracken Pince à iris	88	Ciseaux à strabisme	150
Arlt Anse	83	Braunstein Marqueur	195	Ciseaux à tendons	147
Arruga Pince capsulaire	94	Brauweiler Manche d'irrigation	198	Ciseaux capsulaires	134
Arruga Porte-aiguille	174	Brinkhorst Canule	199	Ciseaux oculaires	148, 149
Aubaret Crochet pointu pour le sac lacrymal	27	Bucher-Kansas Trissecteur	75	Ciseaux pour incision	152
Axenfeld Crochet	27	Bunge Curette pour exentération	54	Ciseaux pour iridectomie	132, 148
Axenfeld Curette à chalazion	53	Buratto LASIK Canule	208	Citelli Emporte-pièce	181
Axenfeld Ecarteur pour le sac lacrymal	22	Buratto LASIK votet de protection	81	Clark Blépharostat	8
Ayer Pince à chalazion	124	Buratto Pince pour IOL	105	Clayman Crochet manipulateur	65
		Buratto Pince pour LASIK flap	120	Clayman Pince pour implantation	103
				Cliveur	70 – 72, 74, 155
<b>B</b>		<b>C</b>		Compas	188, 189
Backhaus Pince à compresses	130	Camellin LASEK		Cook Blépharostat	20
Baird Pince à chalazion	125	entonnoir pour alcool	80	Corbett Aiguille à corps étrangers	51
Bangerter Blépharostat	22	Canule	199 – 210	Corbin Sub tenon canule	202
Bangerter Canule à voie lacrymal	204	Canule à air	203	Corcelle Blépharostat	8
Bangerter Canule retrobulbaire	206	Canule à vitréo-rétinienne	206	Corydon Pince pour capsulorhexis	99, 101
Bangerter Pince musculaire	128	Canule à voie lacrymal	204 – 206	Couteau à cataracte	47, 54
Bangerter Spatule	60, 82	Canule d'aspiration	199, 202	Couteau à dissection	47, 48
Bangerter Spatule à iris	60	Canule enzymes	201	Couteau diamante	36 – 45
Barkan Couteau pour goniotomie	48	Canule irrigatoire	200, 208	Couteau pour goniotomie	48
Barraquer Blépharostat	12, 13	Canule irrigatoire, modèle Bonn	200	Couteau pour l'iris	48
Barraquer Couteau à cataracte	55	Canule pour anesthésie	202, 203	Couteau pour la cornée	48, 49
Barraquer Micro-Porte-aiguille	170	Canule pour aspiration	199	Couteau pour kératoplastique	55
Barraquer Pince à épiler les cils	121	Canule pour aspiration et irrigation	199, 207, 209, 210	Cranz Irrigateur	206
Barraquer Pince à suture	112	Canule pour capsule antérieure	208	Crawford crochet	179
Barraquer pince colibri pour enlever les fils	106	Canule pour cyclodialyse	203	Crawford jeu pour conduits lacrymaux	179
Barraquer Pince-ciseaux à iridectomie	132	Canule pour injection	200	Crochet	26, 27
Barraquer Pince-ciseaux cornéens	140	Canule pour irrigation d'air	203	Crochet à cristallin	68
Barraquer Porte-aiguille	170 – 173	Castroviejo Blépharostat	22	Crochet à décollement de rétine	28
Barraquer Porte-lame de rasoir	166	Castroviejo Canule pour cyclodialyse	203	Crochet à reposition	63
Barraquer spatule pour l'iris	61	Castroviejo Compas	188	Crochet à strabisme	28 – 30
Barraquer-Oosterhuis Blépharostat	11	Castroviejo Dilatateur pour voies lacrymales	180	Crochet à ténotomie	29
Barraquer-Oosterhuis-Kratz Blépharostat	11	Castroviejo Micro-Pince à suture	109 – 111, 160	Crochet diviseur	71, 72, 73, 74, 75, 76, 77
Barraquer-Troutman Micro-Porte-aiguille	167	Castroviejo Micro-Pince-ciseaux	145	Crochet double à fixation	26
Beaupré Pince à épiler les cils	121	Castroviejo Micro-Porte-aiguille	167 – 169	Crochet manipulateur	63 – 6, 71, 72, 74, 155
Beer Pince à épiler les cils	121	Castroviejo Pince à fixer	127	Crochet pour l'iris	60, 155
Beehler Dilateur de pupille	26, 27			Crozafoon MICS Pince pour capsulorhexis	98
Berke Pince musculaire pour ptosis	125, 128				



## Français

Français	Page	Français	Page	Français	Page
Culler Crochet musculaire	29	<b>G</b> Gass crochet	28	<b>I</b> Inamura Pince pour capsulorhexis	98
Culler Spatule pour l'iris	61	Gass Marqueur	25	Irrigateur	206, 210
Curette	53, 54	Gass Punch	185		
Curette à cataracte	54	Gianetti MICS Pince pour capsulorhexis	98	<b>J</b> Jaeger Crochet à strabisme	29
Curette à chalazion	52, 53	Gill Couteau pour la cornée	49	Jaeger Spatule	26
Curette pour éviscération	54	Gill Pince à iris	89	Jaffe Pince à fils	109
<b>D</b> Dardenne Pince à fragments	105	Gill-Hess Micro-Pince à iris	89	Jaffe Pince pour capsulorhexis	97, 162
Dastoor Pince à strabisme	128	Gills Canule pour aspiration et irrigation	199	Jaffe Releveur de paupières	24
Dastoor Pince à suture	112, 116	Gills-Welsh Canule double pour aspiration et irrigation	199	Jaffe Spatule pour la lentille cristalline	69
Dastoor Pince pour conjonctive	119	Gimbel Anneau de fixation LASIK	32	Jaffe-Bechert Crochet manipulateur	65
Daviel Curette à cataracte	54	Gimbel LASIK canule irrigatoire	208	Jameson Crochet à strabisme	28
Dépresseur	25	Girard spatule	78	Jameson Pied à coulisse	189
Desmarres Pince à chalazion	124	Goldstein Ecarteur	23	Jameson Pince pour avancement musculaire	129
Desmarres Releveur de paupières	24	Golf Club Aiguille à corps étrangers	51	Jayle Pince à suture	112
Dieffenbach Serre-fine	130	Gonnin-Amsler Marqueur	196	Jensen Polissoir capsulaire	201
Dilatateur pour voies lacrymales	180, 181	Gouge	50, 51, 52, 182, 183	Jeu pour conduits lacrymaux	179
Dissecteur et spatule	77	Gouge pour le sac lacrymal	182	Johnson-Tooke Couteau pour la cornée	49
Dissecteur LASEK	80	Gradle Pince à épiler	121	Jones Pince à compresses	130
Dissecteur pour la cornée	49	Graefe Couteau à cataracte	47	Jünemann Canule à voie lacrymal	205
Diviseur	71 – 75	Graefe Crochet à strabisme	28		
Draeger Pince pour conjonctive	120	Graefe Crochet pour l'iris	60	<b>K</b> Kalt Porte-aiguille	174
Drysdale crochet manipulateur	66	Graefe Curette à cataracte	54	Kansas Pince à fragments	105
DSAEK Spatule	79	Graefe Pince à fixer	125	Kansas Spatule guide, vectis	75
Dulaney LASIK marqueur pour la cornée	192	Graefe Scarificateur	47	Katzen LASIK spatule pour la cornée	81
		Graefe, Pince à iris	88	Katzin Micro-Pince-ciseaux cornéenne	143
<b>E</b> Ecarteur	22 – 25, 28, 31	Graether Canule	200	Kellnar Trabéculotome	178
Ecarteur de paupières	122	Graether retracteur à iris	60	Kelly Punch Descement	185
Ecarteur pour le sac lacrymal	22, 23	Green Crochet à strabisme	29	Kelman McPherson Pince à fils	106, 156, 157
Ecarteur-spatule orbitaire	31	Green Pince à fixer	126	Kelman McPherson Pince à suture	117, 159
Élévateur	184	Guimaraes LASIK spatule	81	Kératoscope	192
Elschnig Pince à fixer	126	Guthrie Crochet double à fixation	26	Kerrison Emporte-pièce	181
Emporte-pièce	181			Kershner Blépharostat	16
Emporte-pièce capsulaire	184	<b>H</b> Haberle-McPherson Pince pour IOL	105	Kirby Anse	68, 83
Erhardt Pince de paupières	125	Haeflinger phako cliveur	74	Kirby Curette à cristallin	68
Extracteur de cortex	202	Halsted-Mosquito Pince hémostatique	130	Kirby Espresseur	68
		Harms Trabéculotome	178	Kirby Espresseur avec anse	68
<b>F</b> Faulkner Pince pour IOL	105	Harris-Sinsky IOL crochet	64	Kirby Pince à fixer	127
Fechtner Pince pour conjonctive	120	Hartmann Pince hémostatique	130	Knolle spatule pour la cristelline	69
Filtre	215	Hartmann-Halle Spéculum nasal	183	Knolle-Pearce Anse à lentilles avec irrigation	200
Fine-Thornton Anneau de fixation	32	Healon Canule pour injection	200	Knorz Blépharostat avec aspiration	19
Fink Crochet musculaire	26	Hebra Curette à chalazion	52	Koch spatule pour la cristelline	70
Flieringa anneau à fixer	32	Heiss Ecarteur pour le sac lacrymal	23	Kraff Pince capsulaire	96
Francis Aiguille à corps étrangers	51	Helveston Crochet à strabisme	29 – 30	Kratz Polissoir capsulaire	1201
Francis Pince à chalazion	125	Helveston Pince à fils	110	Kratz-Barraquer Blépharostat	10, 11
Freer Ciseau-burin pour le sac lacrymal	182	Henderson Marqueur	193	Kuglen crochet à iris	67
Freer Elévateur	184	Henry Pince à épiler les cils	121	Kuhnt Rugine pour la cornée	49
Frenzl crochet manipulateur	67	Hess Pince à iris	89		
Friedmann gouge coudée	183	Hirschmann Spatule pour la cristelline	64, 69	<b>L</b> La Force Aiguille à corps étrangers	51
Fukasaku canule pour anesthésie	202	Hoffer Anneaux marqueur	190	Lagrange Ciseaux à sclérectomie	152
Fukasaku Cliveur	73, 77	Hofmann-Thornton Anneau de fixation	32	Lambert Pince à chalazion	124
Fukasaku LASIK canule	208	Holth Emporte-pièce capsulaire	184	Lancaster Blépharostat	8
Fukasaku Spatule pour LASIK	81	Hunt Pince à chalazion	124	Laqua Dépresseur scléral	25
				LASEK Dissecteur	80



## Français

Français	Page	Français	Page	Français	Page
LASEK enntonoir pour alcool	80	Micro-Ciseaux		Pince à chalazion	124, 125
LASEK Spatule pour réposition	80	pour cataracte secondaire	133 – 135	Pince à compresses	130
LASEK Trépan	80	Micro-Crochet pour l'iris, modèle Bonn	60	Pince à conjonctive	90, 93
LASIK Canule	208	Micro-Manipulateur	74, 76	Pince à dissequer	90, 93
LASIK Canule irrigatoire	208	Micro-Pince à fils	106 – 110, 157	Pince à entropion	128
LASIK marqueur pour la cornée	192	Micro-Pince à fixer	118, 161	Pince à épiler	121
LASIK Spatule	81	Micro-Pince à fixer, Colibri	118, 161	Pince à fils	106 – 111, 156, 157
LASIK Spatule double	81	Micro-Pince à iris	848 – 91, 160	Pince à fils, type joaillier	110, 111
LASIK Volet de protection	81	Micro-Pince à iris, modèle Bonn	90, 91	Pince a fixer	119, 125 – 127
Lehner Pince pour Capsulorhexis	97, 163	Micro-Pince à suture	1012, 115, 158	Pince á fragments	104, 105, 158
Lester Crochet manipulateur	66, 154	Micro-Pince pour la cornée	117, 118	Pince à implant	103
Lester Pince a fixer	126	Micro-Pince-ciseaux	141, 143, 145	Pince à iris	86 – 91, 160
Lester-Burch Blépharostat	8	Micro-Pince-ciseaux cornéenne	141, 143	Pince à mors croisée	128
Levinson Aiguille	50	Micro-Pince-ciseaux pour kératoplastie	145	Pince à strabisme	128
Lewicky Canule pour capsule antérieure	208	Micro-Porte-aiguille, courbes	163 – 173	Pince à suture	110 – 117, 119, 158 – 160
Lewicky I.O.L. Crochet	64	Micro-Porte-lame de rasoir	166	Pince à suture pour la cornée	113
Liebermann Blépharostat	14, 15, 17	MICS Pince pour capsulorhexis	98, 99	Pince capsulaire	94, 96
Liebermann Mikro Finger	74	Mikro Houe	80	Pince colibri pour enlever les fils	106
Lordan Pince à chalazion	124	Moehle Pince pour la cornée	117	Pince de paupières	125
Lu LASIK marqueur pour la cornée	192	Moody Pince à fixer	126	Pince hémostatique	130
Lu-Mendez Anneau de fixation	32	Moorfield Pince à suture et conjonctiva	119	Pince musculaire pour ptosis	128
Luntz-Dodick Punch trabeculectomie	185	Mueller Ecarteur pour le sac lacrymal	23	Pince pour avancement musculaire	129
<b>M</b> Mackensen Trabéculotome	178	Murdock Blépharostat	20	Pince pour capsulorhexis	97 – 101, 161 – 163
Maddox LASIK Spatule double	81			Pince pour chambre antérieure	96
Maillet	182	<b>N</b> Nagahara Phako cliveur	74	Pince pour conjonctive	119
Maloney Crochet manipulateur	66	Neuhann Phaco cliveur, diviseur	71	Pince pour corps étrangers	121
Maloney Kératoscope	192	New Orleans anse	83	Pince pour DSAEK	120
Manche d'aspiration	198	Noyes pince-ciseaux à iridectomie	132	Pince pour enlever les fils	106
Manche d'irrigation	198, 211	Nugent pince utility	94	Pince pour glaucome	95
Mannis-Buratto LASIK volet de protection	81	<b>O</b> O'Gawa canule		Pince pour implantation lentille cristalline	103
Marqueur	189 – 196	pour aspiration et irrigation	199	Pince pour IOL	105, 139
Marqueur par degré	191	Obstbaum spatule pour la lentille cristalline	69	Pince pour la cornée	117 – 119, 158
Marqueur pour la cornée	190	Ong ciseaux capsulaires	134	Pince pour LASIK Flap	120
Marqueur scléral	25	Osher compas interne	189	Pince pour manchon	121, 122
Masket Pince pour Capsulorhexis	100, 162	Osher crochet manipulateur	67	Pince pour plier	104
Mawas Retracteur d'iris	60	Osher pince joaillier à iris	69	Pince pour „scleral plug“	95
Mc Donald Pince pour plier	104	<b>P</b> Panas Pince à fixer	125	Pince pour sutures	92
Mc Intyre Canule		Park Blépharostat	21	Pince pour vitréo-rétinienne	122, 123
pour aspiration et irrigation	199	Park-Guyton Blépharostat	21	Pince-ciseaux à iridectomie	132
McCullough Pince à disséquer	92	Park-Maumenee Blépharostat	21	Pince-ciseaux à tendons	136, 139, 140
McIntyre Canule à voie lacrymal	205	Paton Dissecteur pour la cornée	49	Pince-ciseaux cornéene	140 – 145
McIntyre Canule pour capsule antérieure	208	Paton Porte-aiguille	174	Pince-ciseaux pour synéchie antérieure	144
McIntyre-Brinkhorst Canule	199	Paton Spatule pour kératoplastie	82	Pisacano rotateur pour cristallin	65
McIntyre Manche	211	Paufique Couteau pour kératoplastie	55	Plange Aiguille à corps étrangers	51
McPherson Micro-Pince à fils	107, 109, 157	Paufique Pince à fils	108	Plateau de pression	146
McPherson Pince fixation pour cornée	117, 119	Paufique Pince à suture	115	Pley Blépharostat	16
McPherson Porte-aiguille	172	Paul Ecarteur, mousse	28	Polack, Pince à suture pour la cornée	113
McPherson-Westcott		Phako cliveur	71, 72, 74	Polissoir capsulaire	201
Pince-ciseaux à tendons	139	Pied á coulisse	189	Polissoir pour capsule	201
Mead Maillet	182	Pierse Micro-Pince à fixer	118, 161	Polissoir pour capsule postérieure	201
Mellinger Blépharostat	9	Pierse-Colibri, Micro-Pince		Porte-aiguille	163, 167 – 175
Mendez LASIK marqueur pour la cornée	192	pour la cornée	118	Porte-lame	166
Mendez Marquer	191	Pigtail Stylet lacrymal	180	Porte-lame de rasoir	166
Mermoud Pince trabeculectomie	95	Pince utility	92, 94	Pre-Chopper	97
Meyhoefer Curette á chalazion tranchante	53			Punch trabeculectomie	185
				Puttermann Pince musculaire	129

## Français

Français	Page	Français	Page	Français	Page
<b>R</b> Randolph Canule pour cyclodialyse	200	Spéculum nasal	183	West Gouge pour le sac lacrymal	182
Règle flexible	189	Spencer Ciseaux pour incision	152	Westcott Pince-ciseaux à tendons	136, 139, 140
Remky Pince à mors croisée	128	St. Martin Pince à suture	115	Wheeler Couteau à dissection	47
Retracteur à iris	60	Steinert Pince pour IOL	103	Wilder Dilatateur pour voies lacrymales	180
Rétracteur orbitaire	31	Stern-Castroviejo Pince à suture	115	Williams Blépharostat, pour adultes	8
Rolf Stylet pour le sac lacrymal	180	Stevens Ciseaux à tendons	151	Wills Hospital cutère petit	92
Rollet Crochet mousse pour le sac lacrymal	27	Stevens Crochet à ténatomie	29	Wiltfang Blepharostat avec aspiration	18
Rollet Rugine pour le sac lacrymal	182	Stevenson Ecarteur pour le sac lacrymal	23	Wright Aiguille pour sutures	180
Rosen diviseur	72, 73, 76	Stylet lacrymal	179, 180	<b>Z</b> Ziegler Couteau pour l'iris	48
Rotateur pour cristallin	65	Sub-Tenon canule pour anesthésie	202, 203	Ziegler Pince à épiler les cils	121
Rugine pour le sac lacrymal	187	Suker Spatule pour cyclodialyse	82		
Rugine pour la cornée	49				
		<b>T</b> Thornton Anneau de fixation	32		
<b>S</b> Sato Couteau pour la cornée	48	Thornton Marqueur pour la cornée	191		
Sauer Blépharostat	20	Tokuda Crochet diviseur à noyau	75		
Sauer Pince à suture	116	Tonomètre	196		
Saupe Pince à épiler les cils	121	Tooke Couteau pour la cornée	49		
Sautter Canule à air	203	Trabéculotome	178		
Sautter Ecarteur-spatule orbitaire	31	Trépan	55, 56, 57		
Scarificateur pour le sac lacrymal	47	Trépan LASEK	80		
Schaaf Pince pour corps étrangers	121	Trissecteur	75		
Schepens Dépresseur scléral	25	Troutman Canule	202		
Schepens Rétracteur orbitaire	31	Troutman Micro-Pince à fils	107, 108, 157		
Schioetz Tonomètre	196	Troutman Micro-Pince pour la cornée	118		
Scott Blépharostat	21	Troutman Micro-Pince-ciseaux cornéenne	143		
Seibel dissecteur et spatule	77	Troutman Micro-Porte-aiguille	168 – 170		
Serre-fine	130	Troutman Micro-Porte-lame de rasoir	166		
Shammas Polissoir pour capsule	201	Troutman Pince à strabisme	128		
Sheets Boucle de lavage	200	Troutman Spatule pour la lentille cristalline	70		
Shepard Pince		Troutman-Barraquer			
pour implantation lentille cristalline	103	Micro-Pince-ciseaux cornéenne	143		
Sichel-Wilder Dilatateur	181	Troutman-Barraquer Micro-Porte-aiguille	173		
Simcoe Canule pour aspiration et irrigation	199	Troutman-Barraquer Spatule pour l'iris	61		
Simcoe Extrateur de cortex	202	<b>U</b> Urrrets-Zavalia marqueur	196		
Simcoe Polissoir pour capsule postérieure	201	Uthoff Ciseaux capsulaires	132		
Sinsky I.O.L. Crochet	63, 154	Uthoff Instrument à noyau rotation	63		
Sloane LASEK Spatule pour réposition	80	Utrata Pince			
Sloane Mikro Houe	80	pour capsulorhexis	97, 101, 161, 162		
Snellen Anse	83	<b>V</b> Vannas Micro-Ciseaux	133 – 135		
Snellen Pince à entropion	128	Vidaurri LASIK Canule irrigatoire	208		
Spatule	60 – 83, 154	Vogt Spatule de mesure	196		
Spatule à synéchies	78	Von Barsewisch Pince			
Spatule de mesure	196	pour la chambre antérieure	96		
Spatule doubles	78, 81	<b>W</b> Walker Pince-ciseaux cornéenne	142		
Spatule échançrée pour énucléer	83	Walton Gouge	50		
Spatule Guide, Vectis	75	Watzke Pince pour manchon	121		
Spatule LASEK	77, 81	Weber Anse	83		
Spatule pour conjonctive	77	Wecker Pince-ciseaux à iridectomie	132		
Spatule pour cyclodialyse	82	Wecker Spatule pour l'iris	61		
Spatule pour kératoplastie	82	Weiss Blépharostat	12		
Spatule pour l'iris	60, 61, 62	Wells Spatule échançrée pour énucléer	83		
Spatule pour la cristalline	70 – 72, 154	Welsh Canule d'aspiration	202		
Spatule pour la lentille cristalline	69 – 72	West Ciseau-burin pour le sac lacrymal	182		
Spatule pour LASIK	77				
Spatule pour phaco	62				





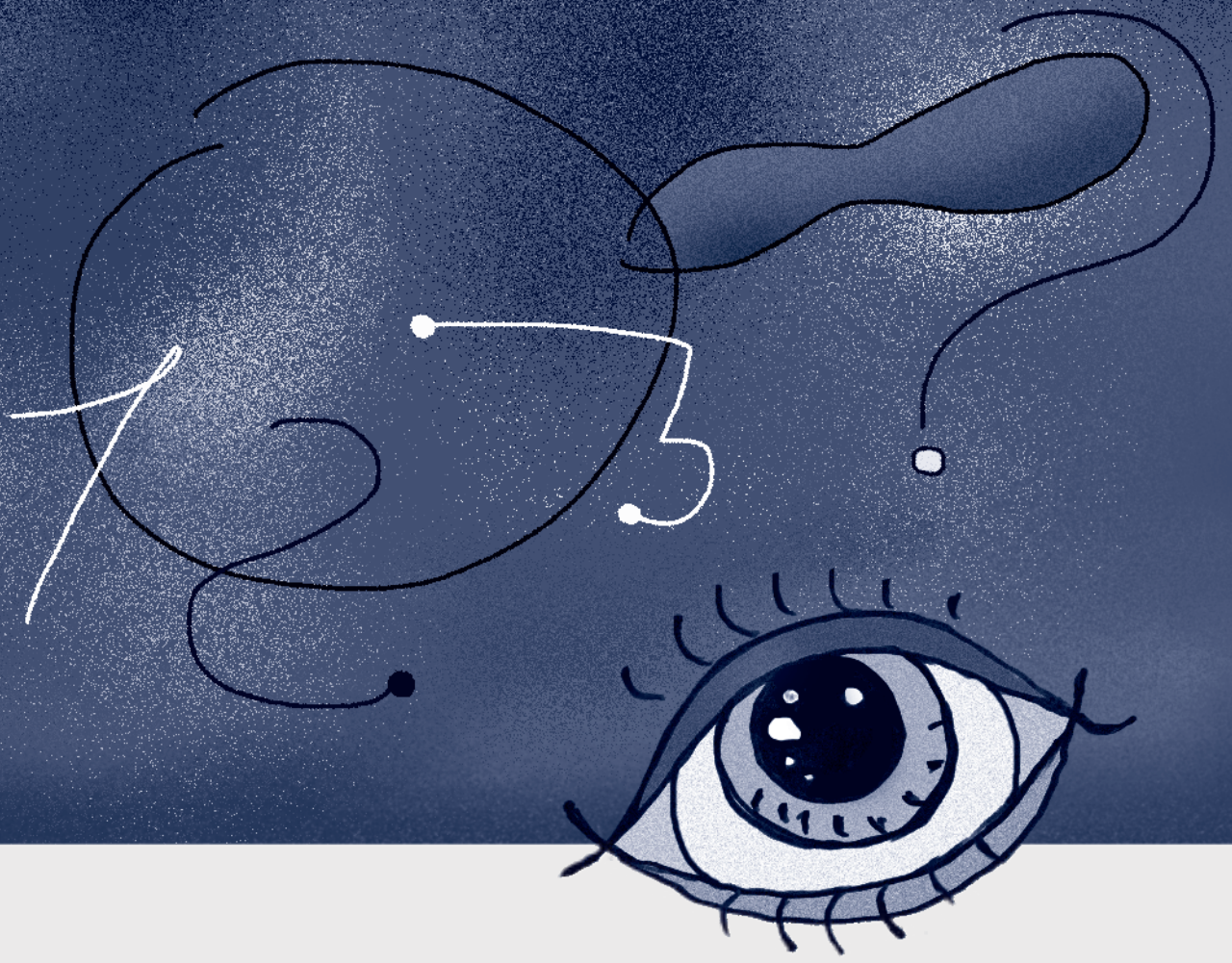

# 13

- ⋮ Artikelnummer Verzeichnis
- ⋮ Numerical Index
- ⋮ Índice numérico
- ⋮ Index numérique

Cat.No.	Seite/Page	Cat.No.	Seite/Page	Cat.No.	Seite/Page	Cat.No.	Seite/Page
H-1001AR	12	H-1052S	14	H-1078L	22	H-1139	25
H-1001A	12	H-1053	14	H-1078R	22	H-1140	26
H-1001B	14	H-1054	15	H-1082	17	H-1162	60
H-1005	8	H-1054A	15	H-1083	17	H-1166	60
H-1008	16	H-1054N	15	H-1084	17	H-1166A	60
H-1010	8	H-1055	17	H-1085	21	H-1200/1	46
H-1011	8	H-1055A	17	H-1090	21	H-1200/2	46
H-1012A	13	H-1056	16	H-1092	21	H-1212	46
H-1012B	13	H-1057	16	H-1094	22	H-1235/1	47
H-1015	8	H-1058A	12	H-1095	22	H-1235/2	47
H-1019	14	H-1058AR	12	H-1096	22	H-1235/3	47
H-1020	18	H-1058A-0.9	12	H-1097	22	H-1250	47
H-1021	18	H-1058B	12	H-1098	13	H-1280	57
H-1022	18	H-1058C	12	H-1099	22	H-1281	57
H-1023	19	H-1058D	12	H-1100	23	H-1290	57
H-1024	19	H-1059	13	H-1105	22	H-1290A	57
H-1025	8	H-1059A	13	H-1110	23	H-1300/1	47
H-1026	19	H-1012A	13	H-1115	23	H-1300/2	47
H-1035	8	H-1060	20	H-1120	23	H-1360	47
H-1037	8	H-1061	20	H-1121	23	H-1380/0	37
H-1040	9	H-1062	13	H-1122	23	H-1380/01	37
H-1040A	9	H-1062A	13	H-1125	24	H-1380/02	37
H-1041	9	H-1063L	13	H-1126	24	H-1380/03	37
H-1041A	9	H-1063R	13	H-1128	24	H-1380/1	37
H-1044	9	H-1064	16	H-1130/1	24	H-1380/2	37
H-1045	10	H-1066A	11	H-1130/2	24	H-1381	41
H-1046	10	H-1066B	11	H-1130/3	24	H-1382/1	42
H-1047	10	H-1066C	11	H-1130/4	24	H-1382/2	42
H-1048	10	H-1067A	11	H-1131/1	25	H-1382/3	42
H-1049	10	H-1067B	11	H-1131/2	25	H-1383/1	45
H-1049N	10	H-1068	11	H-1131/3	25	H-1383/2	45
H-1050	10	H-1069	16	H-1133	25	H-1383/3	45
H-1050R	10	H-1070	20	H-1135/1	25	H-1390/1	36
H-1051	11	H-1071	20	H-1135/2	25	H-1390/2	36
H-1051A	11	H-1072	20	H-1135/3	25	H-1390/3	36
H-1052	14	H-1073	20	H-1136	25	H-1390/4	36
H-1052A	14	H-1074	17	H-1137	25	H-1391/1	36
H-1052N	14	H-1076	21	H-1138	25	H-1391/2	36

Cat.No.	Seite/Page	Cat.No.	Seite/Page	Cat.No.	Seite/Page	Cat.No.	Seite/Page
H-1391/3	36	H-1500/2	48	H-1820	27	H-1926A	72
H-1393/1	43	H-1500/3	48	H-1821	27	H-1927	72
H-1393/2	43	H-1530	48	H-1825	27	H-1928	72
H-1393/3	43	H-1535	48	H-1830	27	H-1929	75
H-1393/4	43	H-1600	49	H-1832	27	H-1930	66
H-1393/5	43	H-1602	49	H-1840	27	H-1930A	66
H-1394/1	44	H-1605	49	H-1842	27	H-1931	66
H-1394/2	44	H-1610	49	H-1842/4	27	H-1932	66
H-1394/3	44	H-1615/1	49	H-1845	28	H-1933	73
H-1394/4	41	H-1615/2	49	H-1860	26	H-1934	71
H-1395/1	38	H-1615/3	49	H-1861	26	H-1935	71
H-1395/2	38	H-1615/4	49	H-1862	27	H-1936	73
H-1395/3	38	H-1630	182	H-1890	28	H-1937	73
H-1395/4	38	H-1650	49	H-1892	28	H-1938	73
H-1395/5	39	H-1670	50	H-1895L	30	H-1339A	74
H-1395/6	39	H-1700	50	H-1895R	30	H-1939B	74
H-1395/7	39	H-1702	50	H-1900/1	28	H-1940	75
H-1395/8	38	H-1704	50	H-1900/2	28	H-1941	75
H-1395/9	38	H-1706	50	H-1900/3	28	H-1942	75
H-1395/10	38	H-1715	50	H-1902	28	H-1943	74
H-1395/11	38	H-1730	50	H-1903	28	H-1945	75
H-1395/12	38	H-1740	51	H-1905	29	H-1946	75
H-1396/1	40	H-1742	51	H-1911	64	H-1947	72
H-1396/2	40	H-1743	51	H-1912	29	H-1958	73
H-1396/3	40	H-1744	51	H-1915	29	H-1958A	73
H-1397/1	41	H-1745	51	H-1916	29	H-1959	73
H-1397/2	41	H-1752	51	H-1917	29	H-1959A	73
H-1397/3	41	H-1753	52	H-1918	29	H-1960	61
H-1397/4	41	H-1760	52	H-1919	30	H-1961	65
H-1397/5	41	H-1770	52	H-1920	29	H-1961A	65
H-1397/6	41	H-1780	52	H-1921	30	H-1962	65
H-1397/7	41	H-1790	184	H-1922	30	H-1963	67
H-1398/1	39	H-1800	60	H-1923	78	H-1963A	67
H-1398/2	39	H-1802	60	H-1924	71	H-1964	67
H-1398/3	39	H-1804	60	H-1925	65	H-1965	67
H-1398/4	39	H-1805/1	26	H-1925A	65	H-1965A	67
H-1398/5	39	H-1805/2	26	H-1925B	65	H-1966	67
H-1500/1	48	H-1810	26	H-1926	71	H-1966A	67



Cat.No.	Seite/Page	Cat.No.	Seite/Page	Cat.No.	Seite/Page	Cat.No.	Seite/Page
H-1967L	74	H-1995	82	H-2095A	62	H-2380	78
H-1967R	74	H-1996	82	H-2095B	62	H-2550/1	55
H-1968L	74	H-1998A	62	H-2095C	62	H-2550/10	55
H-1968R	74	H-1998B	62	H-2099	122	H-2550/11	55
H-1969L	74	H-1998C	62	H-2105	31	H-2550/12	55
H-1969R	74	H-1998D	62	H-2106	31	H-2550/2	55
H-1970/1	61	H-2000	81	H-2107	31	H-2550/3	55
H-1970/2	61	H-2001	81	H-2108	31	H-2550/4	55
H-1971	63	H-2002	81	H-2110	31	H-2550/5	55
H-1971R	63	H-2003	77	H-2120/1	52	H-2550/6	55
H-1971A	63	H-2004	195	H-2120/2	52	H-2550/7	55
H-1971AR	63	H-2005	77	H-2120/3	52	H-2550/8	55
H-1971B	63, 78	H-2005A	77	H-2140	53	H-2550/9	55
H-1972	69	H-2009	81	H-2140/0	53	H-2560/0	56
H-1972A	69	H-2010	81	H-2150/0	53	H-2560/001	56
H-1972AR	69	H-2011	81	H-2150/00	53	H-2560/002	56
H-1972R	69	H-2015	83	H-2150/1	53	H-2560/01	56
H-1973	63	H-2020	83	H-2150/2	53	H-2560/02	56
H-1974	69	H-2022	83	H-2150/3	53	H-2560/03	56
H-1975	64	H-2025/1	83	H-2150/4	53	H-2560/04	56
H-1977	61	H-2025/2	83	H-2165/1	54	H-2560/05	56
H-1978	64	H-2038	70	H-2165/2	54	H-2560/06	56
H-1978R	64	H-2050	80	H-2165/3	54	H-2560/07	56
H-1979	64	H-2051	80	H-2165/4	54	H-2560/08	56
H-1980	65	H-2054	80	H-2180	53	H-2560/09	56
H-1980A	65	H-2055	80	H-2232	78	H-2560/1	56
H-1981	66	H-2056	80	H-2232A	78	H-2560/10	56
H-1981A	66	H-2057	81	H-2315	68	H-2560/11	56
H-1982	61	H-2058	80	H-2325	83	H-2560/12	56
H-1984	74	H-2059	80	H-2335	72	H-2560/13	56
H-1985	82	H-2065	83	H-2336	76	H-2560/14	56
H-1986	69	H-2080	54	H-2337	76	H-2560/15	56
H-1987/1	70	H-2085/1	54	H-2338	72	H-2560/16	56
H-1987/2	70	H-2085/2	54	H-2339	72	H-2560/17	56
H-1988	78	H-2090	68, 146	H-2350	68	H-2560/18	56
H-1992	61	H-2090/1	82	H-2355	68	H-2560/19	56
H-1993/1	61	H-2090/2	82	H-2360	68	H-2560/2	56
H-1993/2	61	H-2090/3	82	H-2370	77	H-2560/20	56

Cat.No.	Seite/Page	Cat.No.	Seite/Page	Cat.No.	Seite/Page	Cat.No.	Seite/Page
H-2560/21	56	H-2597	32	H-2611/7	190	H-2720	130
H-2560/22	56	H-2598	32	H-2611/8	190	H-2725	130
H-2560/3	56	H-2599	32	H-2611/9	190	H-2730	130
H-2560/4	56	H-2600	192	H-2612	190	H-2732	130
H-2560/5	56	H-2602	193	H-2613	190	H-2735	178
H-2560/6	56	H-2603	193	H-2620	189	H-2736	178
H-2560/7	56	H-2604	193	H-2625	196	H-2745	178
H-2560/8	56	H-2605	191	H-2630	188	H-2746	178
H-2560/9	56	H-2606	191	H-2631	188	H-2750	178
H-2561/1	56	H-2607	32	H-2631A	188	H-2751	178
H-2561/10	56	H-2608A	193	H-2632	189	H-2755	130
H-2561/11	56	H-2608B	193	H-2633	189	H-2756	130
H-2561/12	56	H-2609	193	H-2635/0	191	H-2802	179
H-2561/13	56	H-2610/1	1890	H-2635/1	191	H-2802/1	179
H-2561/14	56	H-2610/10	190	H-2635/2	191	H-2802/2	179
H-2561/15	56	H-2610/11	190	H-2635/3	191	H-2802/3	179
H-2561/16	56	H-2610/12	190	H-2636/1	191	H-2802/4	179
H-2561/17	56	H-2610/13	190	H-2636/2	191	H-2802/5	179
H-2561/18	56	H-2610/14	190	H-2636/3	191	H-2802/6	179
H-2561/19	56	H-2610/2	190	H-2636/4	191	H-2802/7	179
H-2561/2	56	H-2610/3	190	H-2636/5	191	H-2802/8	179
H-2561/3	56	H-2610/4	190	H-2637	188	H-2802/9	179
H-2561/4	56	H-2610/5	190	H-2640	191	H-2802/10	179
H-2561/5	56	H-2610/6	190	H-2645	192	H-2812	179
H-2561/6	56	H-2610/7	190	H-2646	192	H-2812/1	179
H-2561/7	56	H-2610/8	190	H-2647	192	H-2812/2	179
H-2561/8	56	H-2610/9	190	H-2648	192	H-2812/3	179
H-2561/9	56	H-2611/1	190	H-2650	198	H-2812/4	179
H-2562	57	H-2611/10	190	H-2651	195	H-2812/5	179
H-2565	80	H-2611/11	190	H-2652	195	H-2812/6	179
H-2566	80	H-2611/12	190	H-2653	195	H-2812/7	179
H-2580	55	H-2611/13	190	H-2655	196	H-2812/8	179
H-2582	55	H-2611/14	190	H-2660	194	H-2812/9	179
H-2584	55	H-2611/2	190	H-2661	194	H-2812/10	179
H-2588	82	H-2611/3	190	H-2670	189, 195	H-2815	180
H-2595/1	32	H-2611/4	190	H-2670A	189, 195	H-2816	180
H-2595/2	32	H-2611/5	190	H-2700	130	H-2829	180
H-2596	32	H-2611/6	190	H-2701	130	H-2830	179

Cat.No.	Seite/Page	Cat.No.	Seite/Page	Cat.No.	Seite/Page	Cat.No.	Seite/Page
H-2835	179	H-3001	86	H-3190	94	H-3329A	108
H-2836	179	H-3002	86	H-3192	94	H-3330	119
H-2840	180	H-3004	89	H-3195	94	H-3331	89
H-2850/0	180	H-3005	109, 146	H-3195A	94	H-3332	106
H-2850/1	180	H-3010	86	H-3200	125	H-3334/1	110
H-2850/2	180	H-3011	86	H-3201	125	H-3334/2	110
H-2850/3	180	H-3012	86	H-3205	125	H-3334/3	110
H-2851	180	H-3020	87	H-3234/1	32	H-3334/4	111
H-2855	180	H-3021	87	H-3234/10	32	H-3334/5	111
H-2857/1	181	H-3030	87	H-3234/11	32	H-3334/6	111
H-2857/2	181	H-3031	87	H-3234/2	32	H-3334/7	111
H-2857/3	181	H-3100	88	H-3234/3	32	H-3335	112
H-2875	181	H-3105	88	H-3234/4	32	H-3336	1111
H-2900/1	181	H-3110	88	H-3234/5	32	H-3337	106
H-2900/2	181	H-3110A	88	H-3234/6	32	H-3338	106
H-2902	181	H-3111	87	H-3234/7	32	H-3339	118
H-2905/0	181	H-3111A	87	H-3234/8	32	H-3339A	118
H-2905/1	181	H-3112	88	H-3234/9	32	H-3340	112
H-2905/2	181	H-3112A	88	H-3245	126	H-3341	112
H-2905/3	181	H-3132	90	H-3255	126	H-3342	106
H-2910	183	H-3133	90	H-3260	126	H-3344	118
H2915/1	183	H-3133A	90	H-3270	122	H-3345	112
H2915/2	183	H-3135	90	H-3280	103	H-3346	112
H2915/3	183	H-3135A	90	H-3282	103	H-3347	107
H-2920	182	H-3136	91	H-3283	103	H-3347A	107
H-2922	182	H-3137	91	H-3285	103	H-3348	107
H-2926	182	H-3138	91	H-3288	106	H-3348A	107
H-2928	184	H-3139	91	H-3288A	105	H-3349A	107
H-2930	182	H-3140	89	H-3290	126	H-3349B	107
H-2930A	182	H-3145	89	H-3292	126	H-3350	113
H-2950	184	H-3158	88	H-3295	128	H-3351	113
H-2982	184	H-3170	92	H-3298	128	H-3352	113
H-2983	185	H-3172	92	H-3300	127	H-3354	113
H-2984	185	H-3180	92	H-3310	127	H-3355	113
H-2984A	185	H-3182	92	H-3312	121	H-3356	113
H-2985	185	H-3185	92	H-3313	121	H-3357A	114
H-2986	185	H-3186	93	H-3315	117	H-3357B	114
H-3000	86	H-3188	93	H-3329	108	H-3357BS	115

Cat.No.	Seite/Page	Cat.No.	Seite/Page	Cat.No.	Seite/Page	Cat.No.	Seite/Page
H-3357C	114	H-3596	116	H-4015C	149	H-4241B	133
H-3357D	114	H-3596A	116	H-4016A	149	H-4242	133
H-3357DA	115	H-3676	96	H-4016B	149	H-4243	134
H-3359	115	H-3720	129	H-4016C	149	H-4245	134
H-3359A	109	H-3720S	129	H-4020	149	H-4246	134
H-3360	115	H-3721	129	H-4021	149	H-4247	135
H-3361	108	H-3721S	129	H-4030	149	H-4247/A	135
H-3361A	108	H-3742	127	H-4031	149	H-4247AB	135
H-3362	115	H-3820	128	H-4050	150	H-4247B	135
H-3362A	115	H-3821	128	H-4051	150	H-4250	138
H-3362B	115	H-3850	128	H-4055	150	H-4251	138
H-3363	116	H-3851	128	H-4056	150	H-4252	138
H-3364	112	H-3901	124	H-4060	150	H-4260	132
H-3365	116	H-3910	124	H-4100	151	H-4270	138
H-3370	119	H-3910A	124	H-4101	151	H-4270G	138
H-3375	118	H-3915	125	H-4110	151	H-4270L	138
H-3376	118	H-3916	125	H-4111	151	H-4271	139
H-3377	118	H-3920/1	124	H-4120	151	H-4272	139
H-3378	118	H-3920/2	124	H-4121	151	H-4272A	139
H-3380	120	H-3920/3	124	H-4130	151	H-4272G	139
H-3380A	120	H-3930	124	H-4131	151	H-4285	143
H-3400	121	H-3935	124	H-4140	152	H-4286	143
H-3410	121	H-3940	124	H-4150	152	H-4290	140
H-3420	121	H-3950	125	H-4155	152	H-4294	137
H-3430	121	H-3955	129	H-4160	148	H-4295	137
H-3450	121	H-3960	127	H-4161	148	H-4300	140
H-3455	121	H-4000	148	H-4180	152	H-4302	141
H-3460	121	H-4000M	148	H-4200/A	132	H-4302A	141
H-3465	128	H-4001	148	H-4200/B	132	H-4303	141
H-3474	127	H-4001M	148	H-4200/C	132	H-4303A	141
H-3530	94	H-4010	148	H-4210/1	132	H-4304	141
H-3535	94	H-4010M	148	H-4210/2	132	H-4305	141
H-3545	95	H-4011	148	H-4210/3	132	H-4306	139
H-3550	94	H-4011M	148	H-4220	132	H-4306A	139
H-3584	89	H-4012	148	H-4225	132	H-4307	141
H-3590	87	H-4013	148	H-4240	133	H-4310	142
H-3592	89	H-4015A	149	H-4240B	133	H-4311	142
H-3595	122	H-4015B	149	H-4241	133	H-4312	142

Cat.No.	Seite/Page	Cat.No.	Seite/Page	Cat.No.	Seite/Page	Cat.No.	Seite/Page
H-4312A	142	H-4565	170	H-5040	204	H-5195	202
H-4315	143	H-4566	170	H-5045	204	H-5196	202
H-4316	143	H-4568	170	H-5046	204	H-5230	200
H-4317	143	H-4569	170	H-5047	204	H-5240	200
H-4318	143	H-4572	171	H-5050	204	H-5250	200
H-4319	142	H-4572A	171	H-5055	204	H-5255	208
H-4325	144	H-4572AB	171	H-5056	205	H-5256	208
H-4326	144	H-4572B	171	H-5057	205	H-5257	208
H-4330	144	H4573A	172	H-5058	205	H-5260	207
H-4360	145	H4573B	172	H-5059	205	H-5261	207
H-4370	140	H4574A	172	H-5060	206	H-5262	207
H-4370G	140	H4574B	172	H-5061	206	H-5263	207
H-4371	140	H-4575	172	H-5062	206	H-5264	207
H-4375	145	H-4576	172	H-5063	206	H-5266	208
H-4400	167	H-4577	173	H-5064	206	H-5270	201
H-4405	167	H-4578	173	H-5065	206	H-5280	201
H-4410	167	H-4579	173	H-5100	203	H-5300	200
H-4415	167	H-4579A	173	H-5140	200	H-5310	200
H-4420	167	H-4579B	173	H-5141	200	H-5320	200
H-4425	167	H-4580	175	H-5142	200	H-5385	202
H-4430	168	H-4580A	175	H-5143	200	H-5386	202
H-4435	168	H-4581	175	H-5145	203	H-5387	202
H-4440	168	H-4581A	175	H-5146	202	H-5390	199
H-4441	168	H-4591	166	H-5147	202	H-5390A	199
H-4450	168	H-4592	166	H-5148	202	H-5391	199
H-4455	169	H-4594	166	H-5149	202	H-5393A	199
H-4460	169	H-4596	166	H-5155	207	H-5393B	199
H-4465	169	H-4600	166	H-5156	207	H-5400	203
H-4500	174	H-4810	198	H-5160	200	H-5410	203
H-4501	174	H-4814	196	H-5162	208	H-5415	203
H-4510	174	H-4815	196	H-5163	208	H-5415A	203
H-4520	174	H-5000	204	H-5164	208	H-5415V	203
H-4550	169	H-5005	205	H-5165	208	H-5510	201
H-4555A	171	H-5006	205	H-5166	208	H-5520	201
H-4555B	171	H-5007	205	H-5167	208	H-5525	201
H-4560	169	H-5010	204	H-5170	200	H-5530	201
H-4562	169	H-5020	204	H-5180	203	H-5535	201
H-4563	170	H-5030	204	H-5185	201	H-5536	201

Cat.No.	Seite/Page	Cat.No.	Seite/Page	Cat.No.	Seite/Page	Cat.No.	Seite/Page
H-5540	202	H-5775	209	H-6085	98	H-6300	122
H-5545	202	H-5776	209	H-6087	99	H-6302	123
H-5546	202	H-5777	210	H-6087G	99	H-6303	123
H-5570	200	H-5778	210	H-6088	99	H-6310	122
H-5590	206	H-5779	210	H-6088G	99	H-6312	123
H-5600	207	H-5780	206	H-6090	101	H-6313	123
H-5610	207	H-6010	97	H-6091	101	H-6320	122
H-5640	211	H-6012	99	H-6092	101	H-6322	122
H-5640A	211	H-6013	99	H-6093	95	H-6330	122
H-5650	211	H-6015	97	H-6094	98	H-6331	123
H-5655	211	H-6015A	97	H-6120A	109	H-6332	123
H-5656	211	H-6016	97	H-6120B	109	H-6333	123
H-5657	211	H-6017	100	H-6130A	119	H-6338	123
H-5660	208	H-6019	100	H-6130B	119	H-6339	123
H-5661	208	H-6019A	100	H-6131A	117	H-6340	122
H-5662	208	H-6020	104	H-6132A	117	H-6342	123
H-5663	208	H-6025	104	H-6132B	117	H-6345	122
H-5664	208	H-6030	104	H-6133A	114	H-6347	123
H-5680	206	H-6035	103	H-6133B	114	H-6355	120
H-5680A	206	H-6038	102, 137	H-6133C	114	H-6356	120
H-5681A	206	H-6040	105	H-6133D	114	H-6357	102, 136
H-5700	198	H-6045	105	H-6140	105	H-6400	146
H-5701	198	H-6050A	108	H-6145	122	H-6402	147
H-5710	198	H-6050B	108	H-6150A	109	H-6403	147
H-5711	198	H-6055	103	H-6150B	105	H-6404	147
H-5720	198	H-6056	105	H-6151A	109	H-6405	146
H-5725	198	H-6060	104	H-6151B	109	H-6407	147
H-5730	198	H-6061	104	H-6155	109	H-6410	146
H-5735	198	H-6062	97	H-6160	119	H-6412	147
H-5740	76	H-6065/A	106	H-6165	126	H-6415	146
H-5745	76	H-6065/B	106	H-6166	126	H-6417	147
H-5750	76	H-6070	105	H-6170	117	H-6420	102, 136
H-5755	77	H-6080	100	H-6175	117	H-7050	216
H-5770	209	H-6081	100	H-6180	96	H-7060	216
H-5771	209	H-6081A	101	H-6190	120	H-7061	216
H-5772	209	H-6082	98	H-6200	96	H-7062	216
H-5773	209	H-6083	98	H-6205	96	H-7063	216
H-5774	209	H-6084	98	H-6210	105	H-7064	216



Cat.No.	Seite/Page	Cat.No.	Seite/Page	Cat.No.	Seite/Page	Cat.No.	Seite/Page
H-7150	186	HT-3420A	157				
H-7151	186	HT-3430	162				
H-7152	186	HT-3431	162				
H-7153	186	HT-3432	162				
H-7154	186	HT-3510	160				
H-7200	33	HT-3520A	160				
HT-1900	154	HT-3520B	160				
HT-1910	154	HT-3520C	160				
HT-1920	155	HT-3520D	160				
HT-1925	154	HT-3525A	157				
HT-1930	154	HT-3525B	157				
HT-1935	155	HT-3530A	158				
HT-1940	155	HT-3530B	158				
HT-1945	155	HT-3540	162				
HT-1945-1	155	HT-3541	162				
HT-1946	155	HT-3542	162				
HT-1950	154	HT-4578A	163				
HT-3000	156	HT-4578B	163				
HT-3010	156	HT-4579A	163				
HT-3020	158	HT-4579B	163				
HT-3021	158	HT-6080	161				
HT-3022	158	HT-6081	161				
HT-3025A	156	HT-6090	161				
HT-3025B	156	HT-6091	161				
HT-3030	156	HT-6094	98				
HT-3031	156						
HT-3035	157						
HT-3036	157						
HT-3110	159						
HT-3111	159						
HT-3120	159						
HT-3121	159						
HT-3130	159						
HT-3376	161						
HT-3378	161						
HT-3415	160						
HT-3420	157						
HT-3420	160						

A large area of the page is filled with horizontal grey lines, serving as a template for taking notes.

Gestaltung und Layoutsatz:

PustlaukDesign GmbH  
D-78532 Tuttlingen  
pustlaukdesign@t-online.de

3500102019



**Albert Heiss – auch digital**

Unser aktuelles Produktsortiment  
erhalten Sie ebenso auf CD.

Oder besuchen Sie uns  
im Internet unter

**[www.albert-heiss.de](http://www.albert-heiss.de)**

**Albert Heiss – in digital quality**

Our actual product portfolio  
is also available on CD-ROM.

Or simply visit us  
on our website

**[www.albert-heiss.de](http://www.albert-heiss.de)**

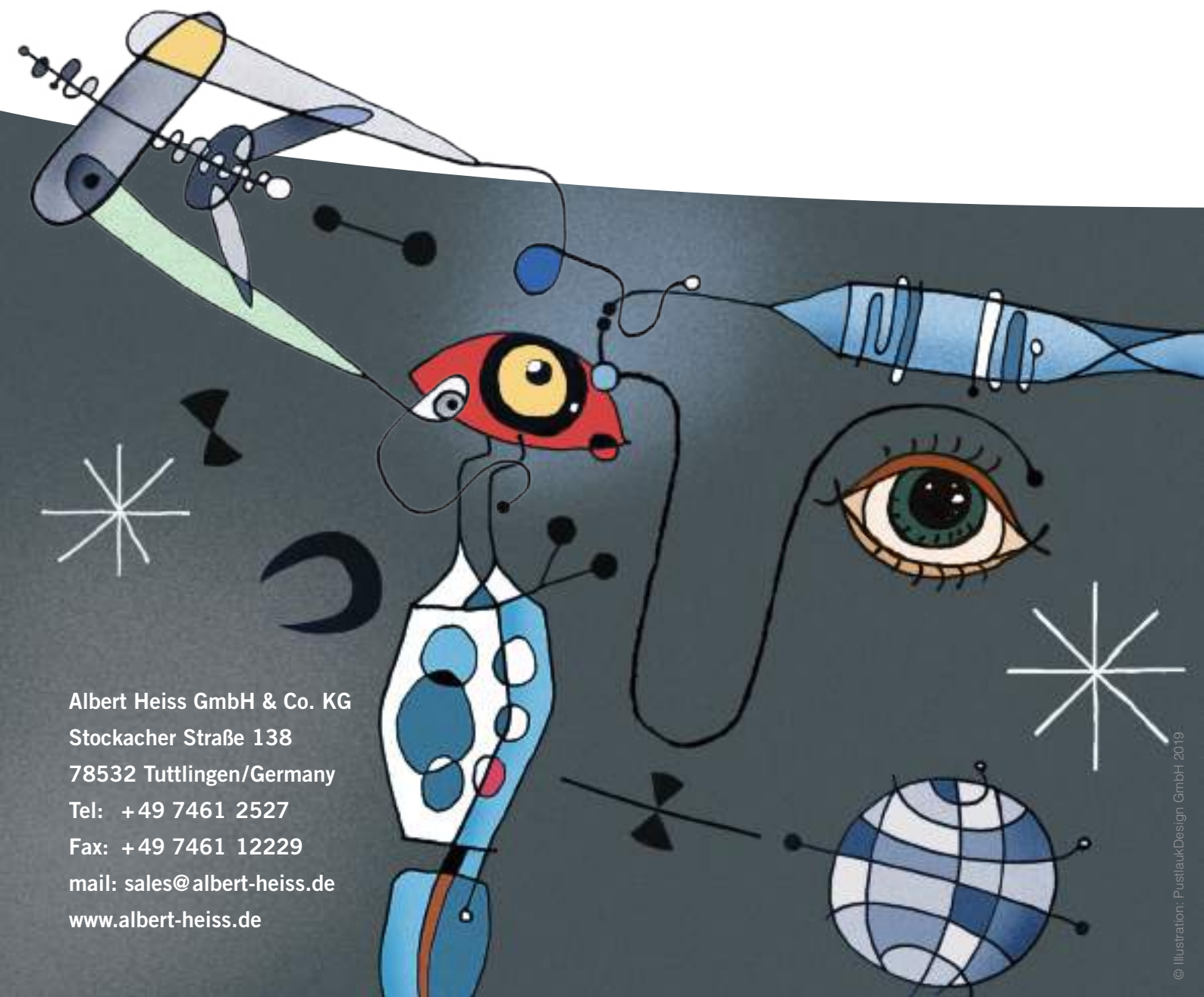

Albert Heiss GmbH & Co. KG  
Stockacher Straße 138  
78532 Tuttlingen/Germany  
Tel: +49 7461 2527  
Fax: +49 7461 12229  
mail: [sales@albert-heiss.de](mailto:sales@albert-heiss.de)  
[www.albert-heiss.de](http://www.albert-heiss.de)